



DeviceNet Scanner Module

Catalog Number 1771-SDN/C

Contents

Use this document as a guide to install your 1771-SDN/C Scanner Module.

To:	See page:
understand important user information	below
prevent Electrostatic Discharge	3
identify related publications	3
understand module compatibility and maintenance	4
understand module enhancements and features	4
identify external scanner module features	6
understand software and hardware requirements	8
set data rate switches for channels 1 and 2	10
set I/O chassis addressing mode switches	11
set node address switches for channels 1 and 2	11
install your module into the chassis	13
connect to the DeviceNet network	14
understand how your module communicates with the PLC [®] processor	16
program your PLC-5 processor	16
configure your module for the DeviceNet™ network	25
use the Explicit Message Program Control feature	26
troubleshoot your module	35
For this reference information:	See page:
Specifications	39

Before you install your module you must know how to:

- program and operate an Allen-Bradley PLC processor
- install and configure devices on your DeviceNet network

Important User Information

Because of the variety of uses for the products described in this publication, those responsible for the application and use of these products must satisfy themselves that all necessary steps have been taken to assure that each application and use meets all performance and safety requirements, including any applicable laws, regulations, codes and standards.

In no event will Allen-Bradley be responsible or liable for indirect or consequential damage resulting from the use or application of these products.

Any illustrations, charts, sample programs, and layout examples shown in this publication are intended solely for purposes of example. Since there are many variables and requirements associated with any particular installation, Allen-Bradley does not assume responsibility or liability (to include intellectual property liability) for actual use based upon the examples shown in this publication.

Allen-Bradley publication SGI-1.1, *Safety Guidelines for the Application, Installation and Maintenance of Solid-State Control* (available from your local Allen-Bradley office), describes some important differences between solid-state equipment and electromechanical devices that should be taken into consideration when applying products such as those described in this publication.

Reproduction of the contents of this copyrighted publication, in whole or part, without written permission of Rockwell Automation, is prohibited.

Throughout this publication, notes may be used to make you aware of safety considerations. The following annotations and their accompanying statements help you to identify a potential hazard, avoid a potential hazard, and recognize the consequences of a potential hazard:

WARNING



Identifies information about practices or circumstances that can cause an explosion in a hazardous environment, which may lead to personal injury or death, property damage, or economic loss.

ATTENTION



Identifies information about practices or circumstances that can lead to personal injury or death, property damage, or economic loss.

IMPORTANT

Identifies information that is critical for successful application and understanding of the product.

Environment and Enclosure

ATTENTION



This equipment is intended for use in a Pollution Degree 2 industrial environment, in overvoltage Category II applications (as defined in IEC publication 60664-1), at altitudes up to 2000 meters without derating.

This equipment is considered Group 1, Class A industrial equipment according to IEC/CISPR Publication 11. Without appropriate precautions, there may be potential difficulties ensuring electromagnetic compatibility in other environments due to conducted as well as radiated disturbance.

This equipment is supplied as "open type" equipment. It must be mounted within an enclosure that is suitably designed for those specific environmental conditions that will be present and appropriately designed to prevent personal injury resulting from accessibility to live parts. The interior of the enclosure must be accessible only by the use of a tool. Subsequent sections of this publication may contain additional information regarding specific enclosure type ratings that are required to comply with certain product safety certifications.

See NEMA Standards publication 250 and IEC publication 60529, as applicable, for explanations of the degrees of protection provided by different types of enclosure. Also, see the appropriate sections in this publication, as well as the Allen-Bradley publication 1770-4.1 ("Industrial Automation Wiring and Grounding Guidelines"), for additional installation requirements pertaining to this equipment.

Prevent Electrostatic Discharge

ATTENTION



This equipment is sensitive to electrostatic discharge which can cause internal damage and affect normal operation. Follow these guidelines when you handle this equipment:

- touch a grounded object to discharge potential static
- wear an approved grounding wrist strap
- do not touch connectors or pins on component boards
- do not touch circuit components inside the equipment
- if available, use a static-safe workstation
- when not in use, store the equipment in appropriate static-safe packaging

Where to Find More Information

The following table describes related documentation. To order a copy or to view or download an online version, visit The Automation Bookstore at:

www.theautomationbookstore.com

For information about:	See this document:	Publication number:
Configuring the scanner module and associated hardware in an example application	1771-SDN DeviceNet Scanner Module User Manual	1771-6.5.132
Performing the ControlFlash Update	ControlFlash Firmware Upgrade Kit User Manual	1756-6.5.6
RSLogix 5™ software	Getting Results with RSLogix 5	9399-RL53GR
RSLinx™ software	Getting Results with RSLinx	9399-WAB32GR
RSNetWorx for DeviceNet™ software	RSNetWorx for DeviceNet Demo CD	9398-DNETDEMO
Connecting the DeviceNet network	DeviceNet Cable Planning and Installation Manual	DN-6.7.2

Module Compatibility and Maintenance Requirements

The 1771-SDN/C DeviceNet Scanner Module is fully compatible with the Series A and Series B versions. You can use the Series C version as a spare or replacement module with one requirement: **you must change the position of Switch 5 to the off or “0” position in the Configuration switchbank as shown below:**

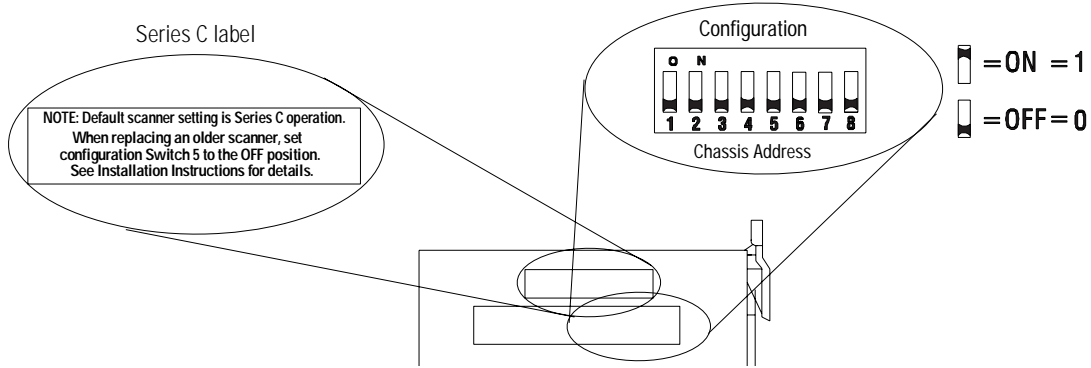

The scanner revision is identified by RSNetWorx. In Series B mode, the scanner is identified as Series B with major number as 4 and minor number as 50. In Series C mode, the scanner is identified as Series C with major number as 6 and minor number as 2 or higher.

To use the Series C module enhancements listed below, the scanner module Configuration Switch 5 must be set in the on or “1” position.

Module Enhancements

Updated DeviceNet Master Library

Electronic Keying - added to include Major and Minor revision checking.

Shared Inputs - multiple scanner modules can acquire the inputs from a specific input device without using separate connections.

Auto Device Replacement (ADR) - consists of Node Recovery and Configuration Recovery:

- **Node Recovery** - this feature causes the node number of the replacement device to be automatically changed to the node number of the original device. The replacement device’s node number must be writable over the DeviceNet network and must initially be set to 63.
- **Configuration Recovery** - this feature causes the replacement device’s configuration to be made identical to the original device. The replacement device’s configuration must be writable over the DeviceNet network. Configuration Recovery files are stored in the master scanner that is communicating with the original device through RSNetWorx for DeviceNet.

Other Features

Change of State

Change of state enables the scanner module to perform a scan:

- whenever a network data change occurs, or
- at a user-configurable heartbeat rate

Because data is only sent on an as-needed basis, this feature increases system performance by reducing network traffic.

Cyclic I/O

Cyclic I/O allows you to instruct the scanner module to perform a scan at a specific send rate.

Because data is only sent at a periodic rate, this feature increases system performance by reducing network traffic.

Pass-Through

The 1771-SDN “pass-through” feature allows communication with the DeviceNet network from another network. This feature can be used to adjust and fine tune the nodes on your network.

For more information on how to use the pass-through feature, refer to Chapter 5 of the PLC-5 DeviceNet Scanner Module User Manual, publication 1771-6.5.132.

External Module Features

Use the drawing below to identify the features of the 1771-SDN/C and B versions of the Scanner Module.

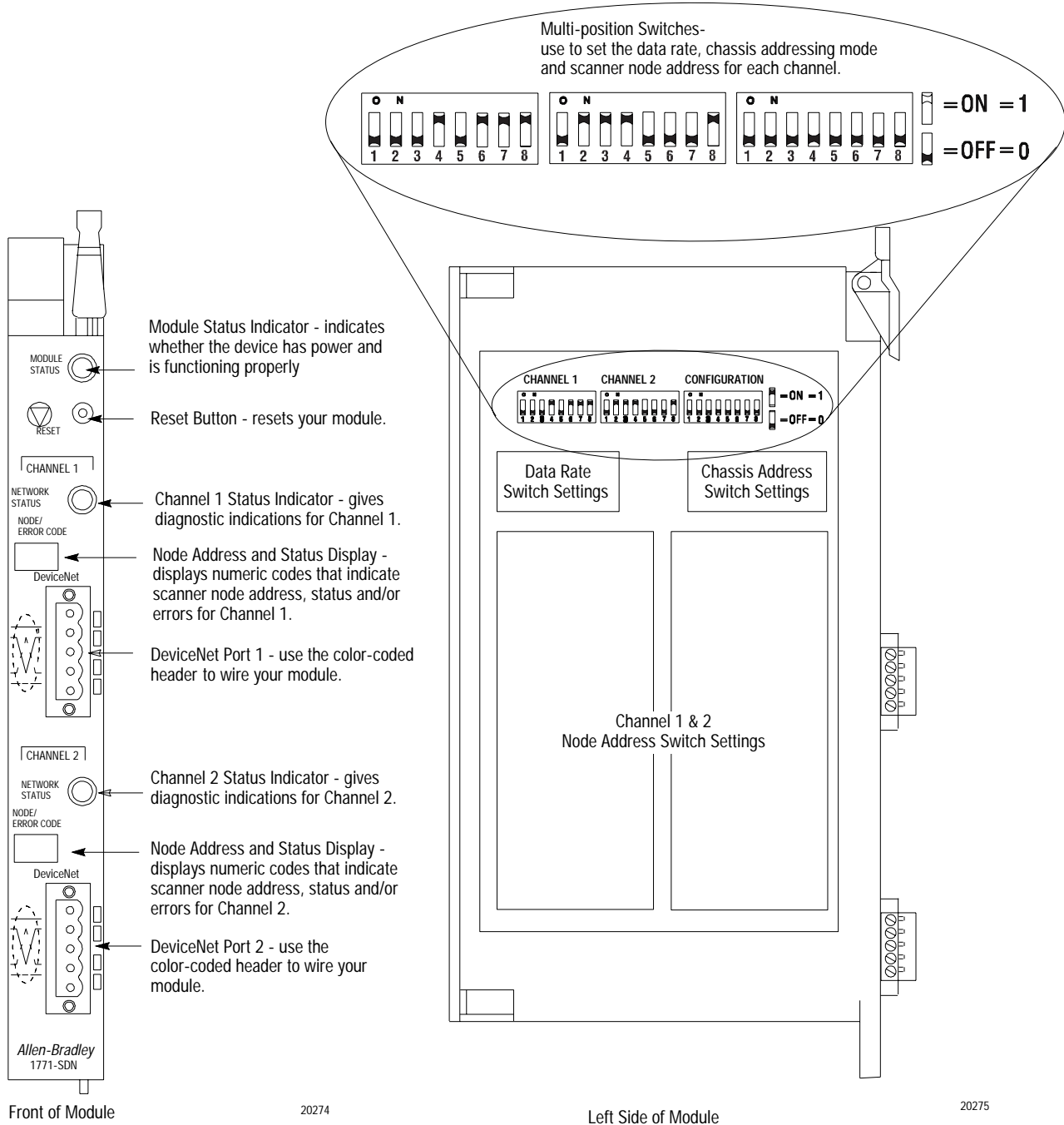

Series A Channel, Port and Switch Identification

The Series A version of this module (1771-SDN) uses different channel, port and switch identification as shown in the following figure:

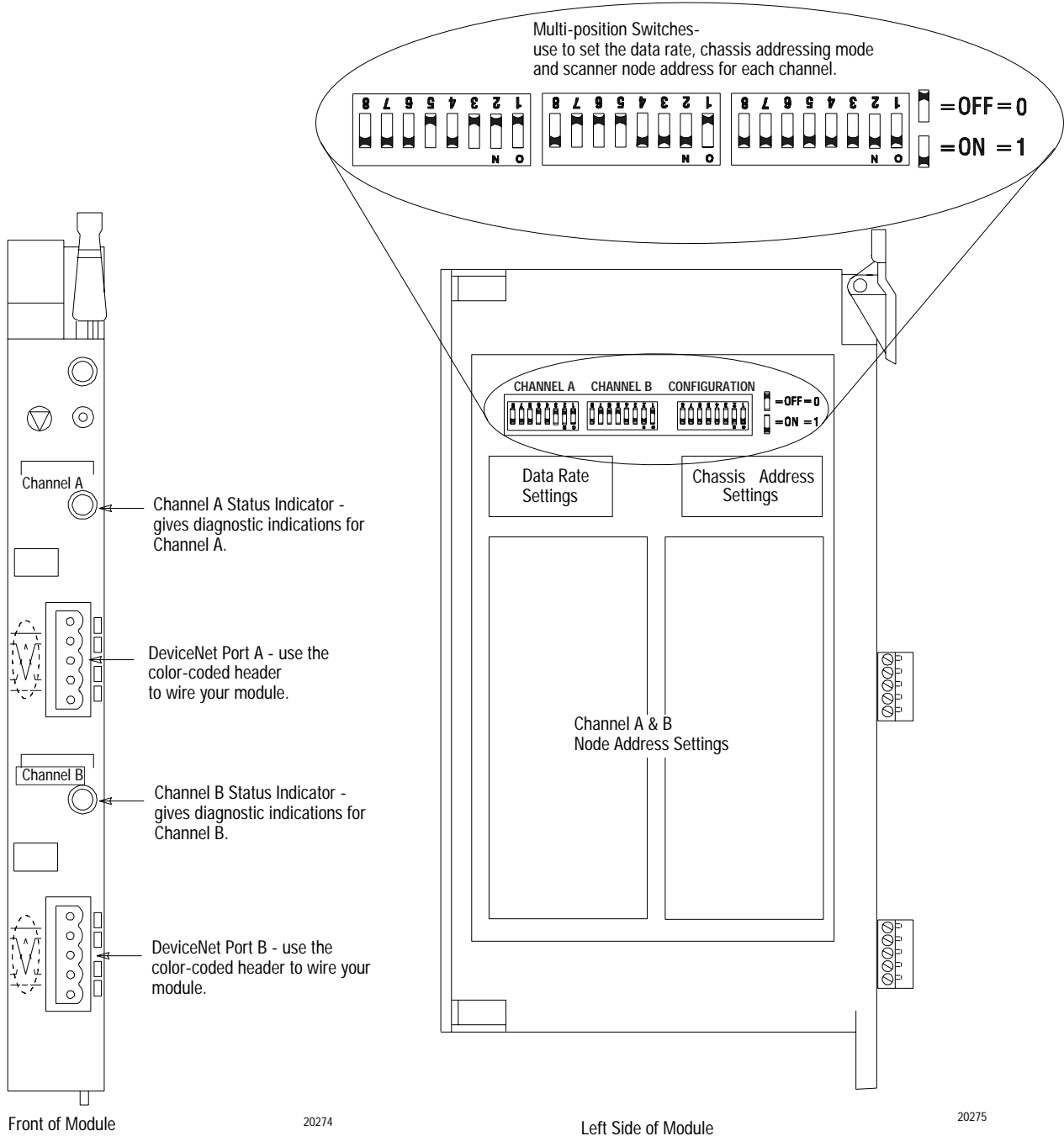

Software and Hardware Requirements

Software Requirements

Before you install the scanner module, make sure you have the following software:

- personal computer with Microsoft Windows™ 95 or later operating system
- RSNetWorx for DeviceNet software, version 2.22 or later
- RSLogix 5 software

Electronic Data Sheet Requirement

To use the new features of this release, the scanner module requires the latest EDS file for RSNetWorx for DeviceNet software. If the software displays the device as an “unknown device”, you must download the current EDS file.

You can get the latest EDS file online at:

<http://www.ab.com/networks/eds>

Once you are at this location:

1. Select `DeviceNet`
2. Enter the catalog number: `1771-SDN`
3. Select Search

Hardware Requirements

The 1771-SDN Scanner Module is compatible only with the 1771-A1B through 1771-A4B or later I/O chassis in any configuration supported by the 1771 family.

You can use the following chassis with the 1771-SDN Scanner Module:

- Local I/O Chassis with only the PLC processor running in the leftmost slot
- Extended Local I/O Chassis with any 1771-ALX Adapter Module running in the leftmost slot
- Remote I/O Chassis with a 1771-ASB Adapter Module running in the leftmost slot or a PLC processor running in the leftmost slot

- Remote I/O Chassis linked to ControlNet with a 1771-ACN(R) running in the leftmost slot

Do not use the 1771-SDN Scanner Module with the following:

- Chassis configured for complementary I/O
- Remote I/O chassis connected to a preceding chassis using a 1771-SN Sub I/O Scanner Module

IMPORTANT

The 1771-SDN Scanner Module fits in any slot of the chassis except for the leftmost slot, which is reserved for the PLC processor. The scanner module will not conflict with other 1771 I/O devices in the chassis. You can install multiple scanners in the same chassis.

The 1771-SDN Scanner Module is compatible with any PLC-2[®], PLC-3[®] or PLC-5[®] processor that supports block transfer read and write instructions. The example configurations in these installation instructions use a PLC-5 processor.

Perform the ControlFLASH Update

If you have the previous release of firmware and you want to upgrade it to this release, you must perform the ControlFLASH update. To get the kit, contact Rockwell Automation Technical Support at 440.646.5800. To install the kit, refer to the ControlFLASH Firmware Upgrade Kit User Manual, publication 1756-6.5.6.

Before you install your module you must set the following switches:

- data rate for each DeviceNet channel
- I/O chassis addressing mode (1/2, 1 or 2-slot addressing)
- scanner node address for each channel

Set the Data Rate Switches for Channels 1 and 2

To set the DeviceNet data rate switches for Channels 1 and 2:

1. Locate the switchbank labeled “Channel 1” on the left side of the module.
2. Use the table below to determine the data rate you want to set for “Channel 1.” Record your choice in the fourth column.

Channel 1 and 2			
Data Rate	Switch Position		Note Your Data Rate
	1	2	
125K baud	0	0	
250K baud	0	1	
500K baud	1	0	
Not allowed	1	1	

3. Using a ball point pen or similar object, adjust switches 2 and 1 to your desired data rate setting. **(NOTE: Do not use a pencil to adjust switches. The lead may break off in the switchbank.)** Slide the switches up to denote an on or “1” position. Slide the switches down to denote an off or “0” position.

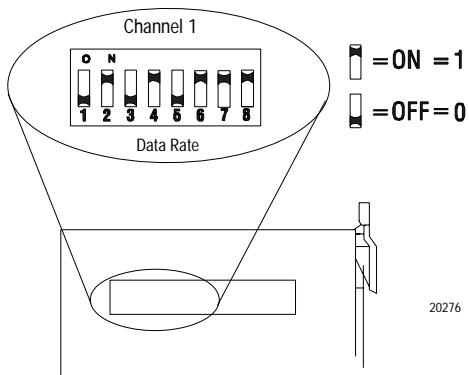

20276

For example, if you want to set DeviceNet data rate of 500K baud for Channel 1, then you set switch 2 to an off or “0” position and switch 1 to an on or “1” position.

Data Rate	Sw.1	Sw.2
500K	1	0

4. Repeat steps 1-3 to set the DeviceNet data rate for Channel 2, using the switchbank labeled “Channel 2”. Adjust the switches to your desired data rate setting.

To set the I/O chassis addressing mode switches:

1. Locate the switchbank labeled “Configuration” on the left side of the module.
2. Use the following table to determine the chassis addressing mode you want to set. Record your choice in the fourth column.

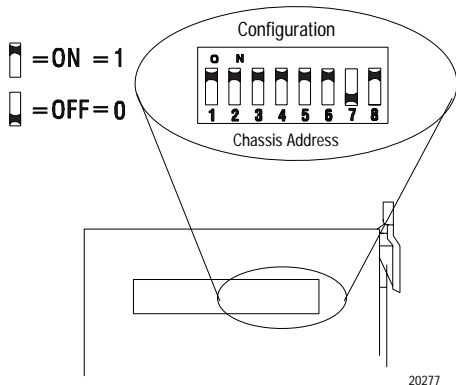

20277

Note: The scanner module consumes/produces 8 bits of discrete output/input for the processor connection. Therefore, the scanner module cannot be placed next to a 16-point module when using 1-slot addressing.

I/O Chassis Addressing Mode			
Mode	Switch Position		Note Your Mode
	7	8	
2-slot	0	0	
1-slot	0	1	
1/2-slot	1	0	
Not allowed	1	1	

- Using a ball point pen or similar pointed object, adjust switches 7 and 8 to your desired chassis addressing mode. Slide the switches up to denote an on or “1” position. Slide the switches down to denote an off or “0” position. **Make sure switches 1 through 4 and 6 in the switchbank labeled “Configuration” always remain in the off or “0” position. For Series C functionality, make sure switch 5 is in the on or “1” position.**

ATTENTION



The I/O chassis address setting must match the chassis addressing mode setting for the 1771 chassis. If the switches do not match, data will be lost in the data transfer between the PLC-5 processor and the scanner module.

Set Node Address Switches for Channels 1 and 2

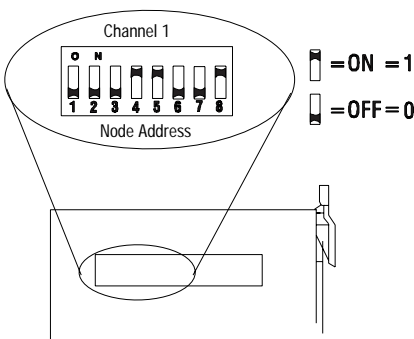

For more information about addressing, refer to your PLC processor system level installation manual and design manual.

To set the scanner DeviceNet node address:

- Locate the switchbank labeled “Channel 1”, on the left side of the module.
- Use the following table to determine the node address you want to set for the module on Channel 1, and note your choice. The address range is 0 to 63.
- Using a ball point pen or similar object, adjust switches 3 through 8 to your desired node address settings. Slide the switches up to denote an on or “1” position. Slide the switches down to denote an off or “0” position.
- Using a ball point pen or similar object, adjust switches 3 through 8 to your desired node address settings. Slide the switches up to denote an on or “1” position. Slide the switches down to denote an off or “0” position.

5. Repeat steps 1–3 to set the scanner node address for Channel 2, using the switchbank labeled “Channel 2”. Adjust the switches to your desired node address setting.

IMPORTANT

The node address setting for DeviceNet Channel 1 must not conflict with the node address of any other device on the network.

Channel 1 and 2 Node Address							Channels 1 and 2 Node Address						
Node Address	Switch Position						Node Address	Switch Position					
	3	4	5	6	7	8		3	4	5	6	7	8
0	0	0	0	0	0	0	32	1	0	0	0	0	0
1	0	0	0	0	0	1	33	1	0	0	0	0	1
2	0	0	0	0	1	0	34	1	0	0	0	1	0
3	0	0	0	0	1	1	35	1	0	0	0	1	1
4	0	0	0	1	0	0	36	1	0	0	1	0	0
5	0	0	0	1	0	1	37	1	0	0	1	0	1
6	0	0	0	1	1	0	38	1	0	0	1	1	0
7	0	0	0	1	1	1	39	1	0	0	1	1	1
8	0	0	1	0	0	0	40	1	0	1	0	0	0
9	0	0	1	0	0	1	41	1	0	1	0	0	1
10	0	0	1	0	1	0	42	1	0	1	0	1	0
11	0	0	1	0	1	1	43	1	0	1	0	1	1
12	0	0	1	1	0	0	44	1	0	1	1	0	0
13	0	0	1	1	0	1	45	1	0	1	1	0	1
14	0	0	1	1	1	0	46	1	0	1	1	1	0
15	0	0	1	1	1	1	47	1	0	1	1	1	1
16	0	1	0	0	0	0	48	1	1	0	0	0	0
17	0	1	0	0	0	1	49	1	1	0	0	0	1
18	0	1	0	0	1	0	50	1	1	0	0	1	0
19	0	1	0	0	1	1	51	1	1	0	0	1	1
20	0	1	0	1	0	0	52	1	1	0	1	0	0
21	0	1	0	1	0	1	53	1	1	0	1	0	1
22	0	1	0	1	1	0	54	1	1	0	1	1	0
23	0	1	0	1	1	1	55	1	1	0	1	1	1
24	0	1	1	0	0	0	56	1	1	1	0	0	0
25	0	1	1	0	0	1	57	1	1	1	0	0	1
26	0	1	1	0	1	0	58	1	1	1	0	1	0
27	0	1	1	0	1	1	59	1	1	1	0	1	1
28	0	1	1	1	0	0	60	1	1	1	1	0	0
29	0	1	1	1	0	1	61	1	1	1	1	0	1
30	0	1	1	1	1	0	62	1	1	1	1	1	0
31	0	1	1	1	1	1	63	1	1	1	1	1	1

Install Your Module into the Chassis

Before you insert the module into the chassis, set all switches in accordance with the requirements of your networks. You must set the switches before you install the the 1771-SDN Scanner Module or it will not function properly.

WARNING



If you insert or remove the scanner module with power applied to this module or any device on the network, an electrical arc can occur. This could cause an explosion in hazardous location installations. Be sure that power is removed or the area is nonhazardous before proceeding.

1. Select a slot for the module in the chassis. You may use any slot except the leftmost slot, which is reserved for the PLC processor.
2. Adjust the chassis' keying bands (see figures below).

The 1771-SDN Scanner Module uses keying bands to prevent placing modules into the wrong slot. You can key any connector in an I/O chassis to receive the module except for the leftmost connector, which is reserved for adapter or processor modules.

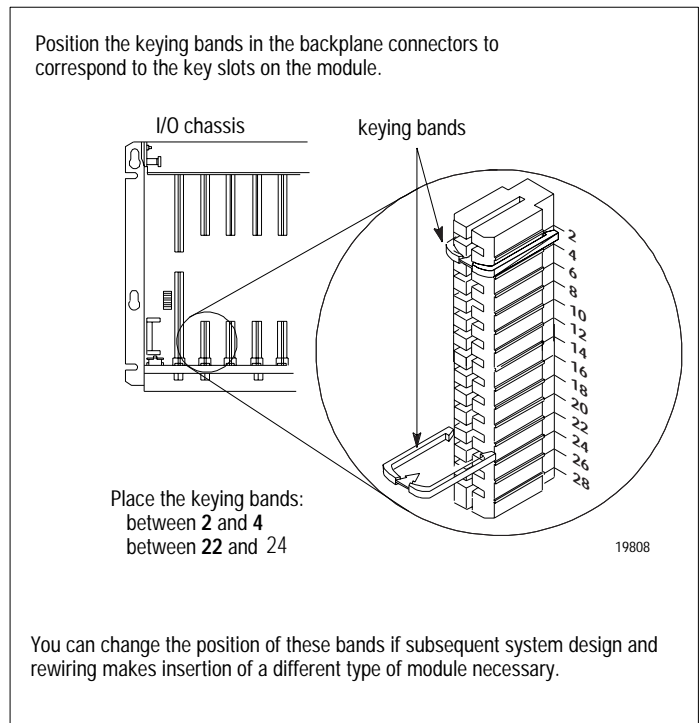
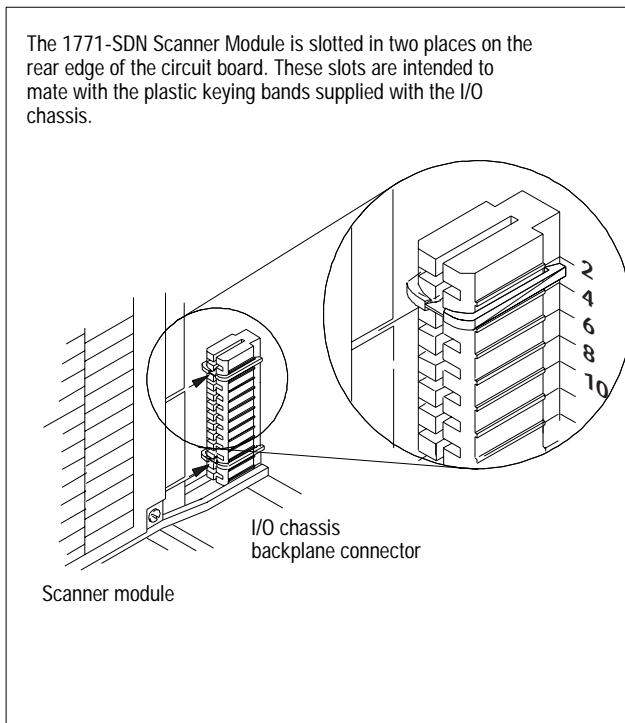

3. Insert the 1771-SDN Scanner Module into the slot you have selected.

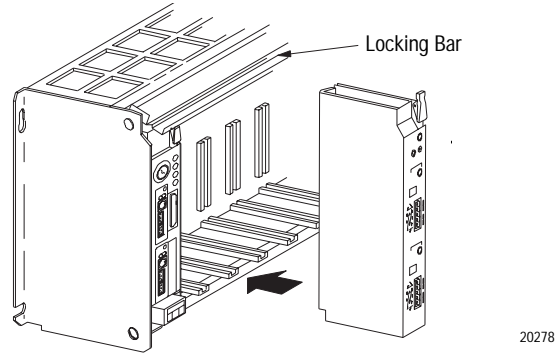

4. Apply firm, even pressure to seat the module in the I/O chassis backplane connectors.
5. Swing the locking bar down until locked in place to make sure that you have secured the module in the slot.

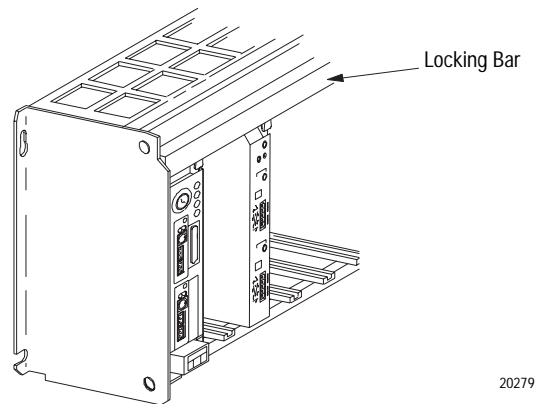

Connect to the DeviceNet Network

To connect to the DeviceNet network:

WARNING



If you insert or remove the scanner module with power applied to this module or any device on the network, an electrical arc can occur. This could cause an explosion in hazardous location installations. Be sure that power is removed or the area is nonhazardous before proceeding.

1. Connect the DeviceNet drop line to the linear plug, by matching the wire insulation colors to the colors shown on the label:

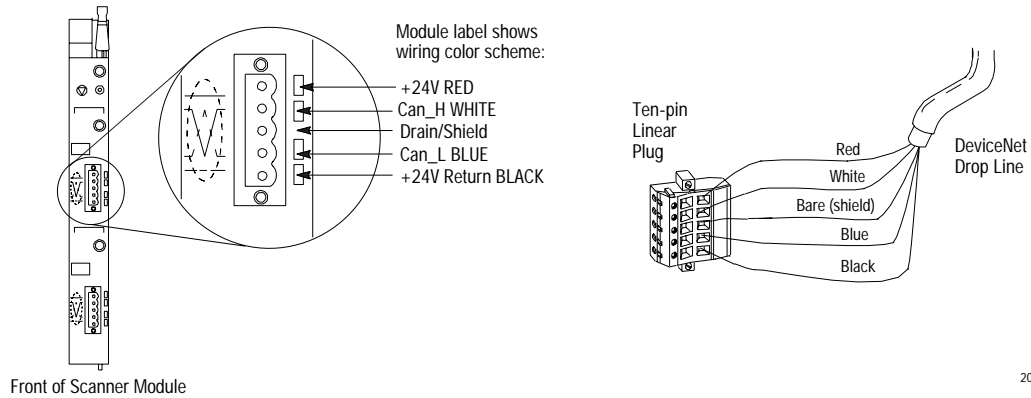

2. Locate the DeviceNet Port 1 connector for Channel 1 on the front of the module.
3. Insert the linear plug into the five-pin header for Channel 1.

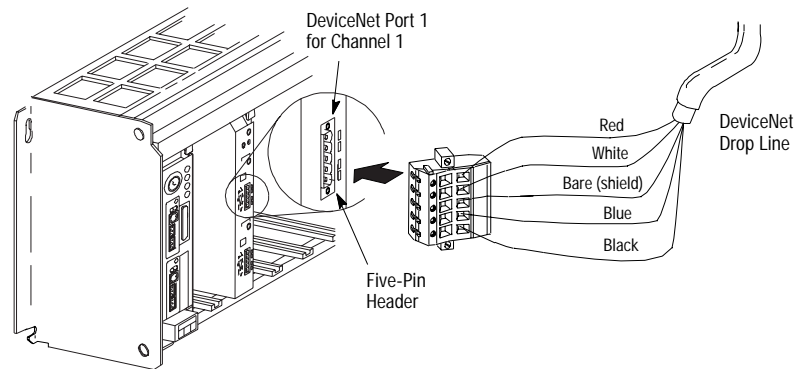

4. Repeat steps 1–3 for Channel 2, if necessary.

Module installation is complete. To operate the module, you must program the PLC processor to communicate with it. In the following two sections, we describe how your module communicates with the PLC-5 processor and how to program your processor.

WARNING



If you connect or disconnect the DeviceNet cable with power applied to this module or any device on the network, an electrical arc can occur. This could cause an explosion in hazardous location installations. Be sure that power is removed or the area is nonhazardous before proceeding.

How Your Module Communicates with the PLC-5 Processor

The 1771-SDN scanner module uses four methods to transfer data, status and command information between the scanner and the PLC-5:

- DIO points for high-speed discrete outputs
- DIO points for high-speed discrete inputs
- BTW to send output data to the scanner
- BTR to upload input data from the scanner

Using DIO Points for High-Speed Discrete Inputs and Outputs

The following table describes chassis addressing modes and the number of discrete inputs and outputs assigned to the 1771-SDN Scanner Module slot.

Addressing Mode	Discrete Inputs	Discrete Outputs
1/2-slot	24	24
1-slot	8	8
2-slot	0	0

These inputs and outputs will appear in the PLC I/O image table in the location corresponding to the rack, group and slot the module is plugged into. Since the bits are in the I/O table, they can be forced.

For more information about chassis addressing modes, refer to your PLC-5 processor system level installation manual.

Program Your PLC-5 Processor

You must program your PLC-5 processor so it communicates with the 1771-SDN Scanner Module. Communication is possible when you program your processor through multiple block transfer instructions. The scanner uses the size of the block transfer to map the block transfer data words into the scanner's internal data table. The scanner module accepts blocks of different sizes and knows that each block has a different meaning.

PLC-5 block transfer instructions use one integer file in the data table section for module location and other data to execute the instruction. This is the control block file. The block transfer data file stores data that you want to transfer **to** your module (when programming a block transfer write (BTW)) or **from** your module (when programming a block transfer read (BTR)). The address of the block transfer data file is stored in the control block file.

You must select a separate data file for each of the block transfer instructions. **You must also use separate 5-word block transfer**

control files for each of the block transfer instructions when an integer file is used. This is not necessary when a control block file is a BT data type.

To make sure the instruction is reset after the block transfer completes and recycles, you must use enable bits as the conditions on each rung with the PLC-5. The following figure shows a PLC-5 sample program.

IMPORTANT

The module does not support continuous mode block transfer. Set **Continuous** to **NO** for each BTW or BTR.

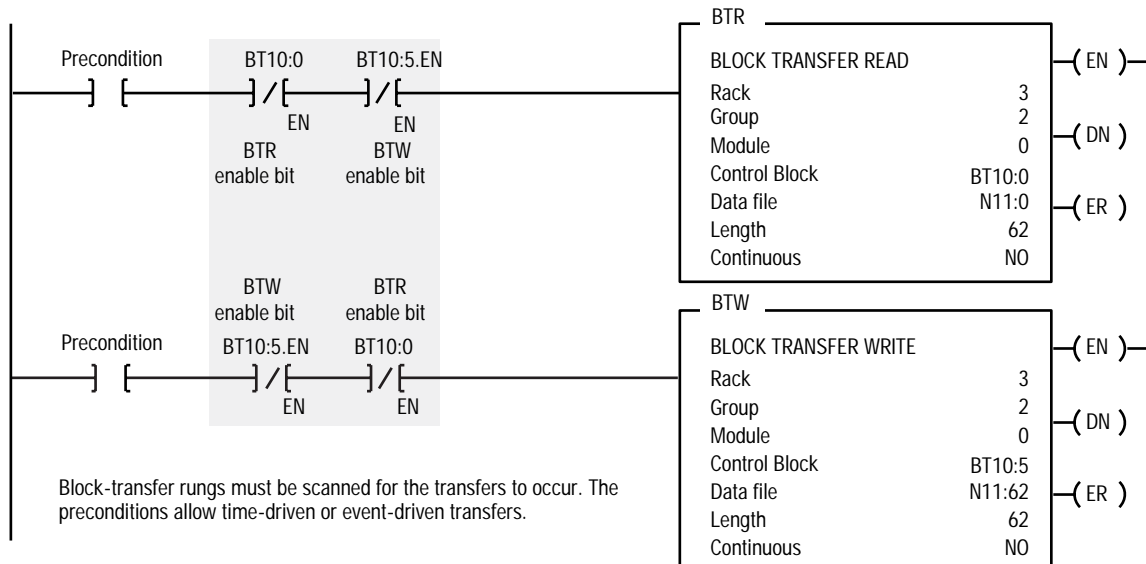

When using rungs like those in the preceding figure, the processor alternates between the BTR and the BTW, waiting to request the next block transfer until the previous block transfer is completed. When only one block transfer is active at a time, it is considered a single-threaded block transfer. Single-threaded block transfers operate in an orderly sequence of read and write, however, they are slower than the asynchronous method, shown below:

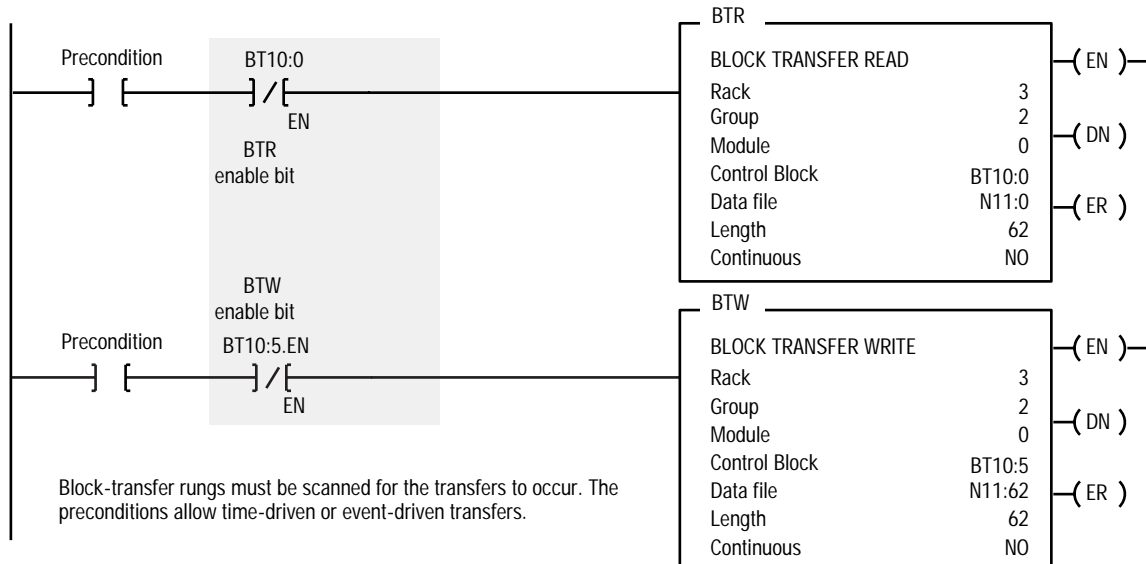

As soon as an asynchronous block transfer completes, it is requested again, independent of other block transfers going to the same module. If you have programmed many block transfers to the same logical rack (especially a remote rack), you will fill the processor's queue. In this situation, the asynchronous method can result in irregular timing between successive executions of the same block transfer.

For more information on programming and block transfers, refer to your PLC-5 Programming Software Instruction Set Reference Manual, publication 1785-6.1.

Using BTW to Send Outputs to the Scanner

The PLC-5 downloads output data to the scanner using block transfer write instructions over the 1771 backplane. The scanner module can update a maximum of 357 output words by internally linking together six different sized block transfers as shown in the following table.

Block Transfer Size	Accessed Scanner Output Block	Scanner Output Data Table
62 words	Block 62	Word 0 – Module Command Register Word Words 1–61
61 words	Block 61	Words 62–122
60 words	Block 60	Words 123–182
59 words	Block 59	Words 183–241
58 words	Block 58	Words 242–299
57 words	Block 57	Words 300–356
1-50 words	Block 1-50	Words 0-49

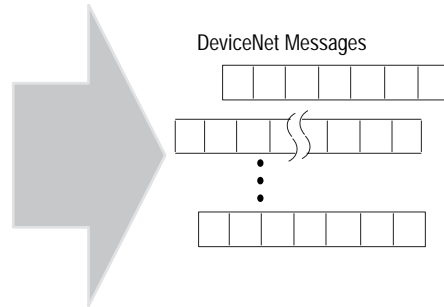

Each individual block transfer is independent, but always updates the same output bytes in the scanner's memory table. Of the scanner output words 0 through 61, the word 0 is reserved for the Module Command Register. Block transfer sizes 1 through 50 update scanner output words 0 through 49, thus reducing the required BTW time when 50 or fewer output words are needed. Sizes 51 thru 56 are illegal and size 64 is used for Explicit Message Program Control. For more details on Explicit Message Program Control, refer to page 26.

If the scanner receives a BTW of 62 words, then it knows that it contains the first block of the table. A BTW of 61 words, if necessary, contains the second block of the table and so on for 60, 59, 58 and 57 words.

You determine the data that is exchanged with a given node on channel 1 or 2 by creating custom configurations using RSNetworx software version 2.22 or later. Refer to your RSNetworx documentation or online help and your 1771-SDN Scanner Configuration Manual (publication number 1771-6.5.132) for more information on custom configurations.

Module Command Register

The first word of the BTW downloaded from the PLC-5 to block 62 is reserved as the module command register. The register is downloaded with every 1 through 50 and 62 word block transfer write. This modifies the scanner's operation.

To execute a command, you set the appropriate bits in the module command word, then perform a block transfer write to the first block (the 62 word block) of the scanner output table. When the scanner receives the command it immediately executes it. You latch bits 0 through 5 in your program to maintain the scanner's desired state.

The following table outlines the module command register's bit numbers and descriptions.

Module Command Register - Word 0, Block 62				
Bit Number	Bits		Operating Mode	Operating Mode Description
	01	00		
00 - 01	0	0	DeviceNet Channel 1 in idle mode	<p>Idle The scanner does not map output data to the devices, but keeps network connections to devices open so device failures can be detected. Input data is returned from devices, and mapped into the scanner input table and the discrete inputs. Outputs on the network are not under program control and will be in their configured 'idle state.' The scanner must be put into this mode to perform configuration of the scanner database tables.</p> <p>Run The scanner module maps output data from its scanner output table and discrete outputs to each device on the network. Inputs are received and mapped into the scanner input table and discrete inputs. Outputs on the network are under program control. Placing the PLC-5 into PROG or REM_PROG mode places the scanner into idle mode regardless of the state of the bits in the module command register. Placing the PLC-5 into RUN or REM_RUN mode causes the state of the bits in the module command register to determine the scanner state.</p> <p>Fault Network The scanner stops communicating with devices on the network. No outputs or inputs are mapped. Outputs on the network are not under program control. If the scanner was in run, devices will go to their configured 'fault state.'</p> <p>Enable The DeviceNet channel is enabled for communication. This is the normal operating state of the channel.</p> <p>Disable The DeviceNet channel is disabled for communication. No communication may occur over this channel. Outputs on the network are not under program control. If the scanner was in run, devices will go to their configured 'fault state.' Numeric error code 90 will occur when channel is disabled.</p> <p>Scanner Active This is the normal operating mode of the scanner.</p> <p>Scanner Halt All scanner operations stop when this command is issued. No communications occur over either DeviceNet port. No block transfer or discrete I/O mapping occurs. Outputs on the network are not under program control. If the scanner was in run, devices will go to their configured 'fault state.' Numeric error code 97 will occur - you must reset the scanner or cycle power to the scanner to recover from this state.</p> <p>Scanner Reboot This command causes the scanner to reset as though the reset button had been pressed. When this command is issued, all scanner communication stops for the duration of the scanner's initialization sequence. Outputs on the network are no longer under program control. If the scanner was in run, devices will go to their configured 'fault state.'</p>
	0	1	DeviceNet Channel 1 in run mode	
	1	0	DeviceNet Channel 1 in fault mode	
	1	1	Reserved	
02 - 03	0	0	DeviceNet Channel 2 in idle mode	
	0	1	DeviceNet Channel 2 in run mode	
	1	0	DeviceNet Channel 2 in fault mode	
	1	1	Reserved	
04		0	Enable DeviceNet Channel 1	
		1	Disable DeviceNet Channel 1	
05		0	Enable DeviceNet Channel 2	
		1	Disable DeviceNet Channel 2	
06		0	Scanner run	
		1	Scanner halt	
07		0	Scanner Active	
		1	Scanner reboot	
08 - 15		0	Reserved for future use	

Use BTR to Upload Input Data from the Scanner

The PLC-5 uploads input data from the scanner using block transfer read instructions over the 1771 backplane. The scanner interprets BTRs of length 1 through 50 and 62 words as being from the first block of the scanner input table. The scanner module can update a maximum of 357 input words by internally linking together six different sized block transfers. See the table below.

Block Transfer Size	Accessed Scanner Input Block	Scanner Input Data Table
62 words	Block 62	Word 0 – Module Status Register Word
		Words 1–61
61 words	Block 61	Words 62–122
60 words	Block 60	Words 123–182
59 words	Block 59	Words 183–241
58 words	Block 58	Words 242–299
57 words	Block 57	Words 300–356
52 words	Block 52	Device Failure Table
51 words	Block 51	Device Active Table
1-50 words	Block 1-50	Words 0–49

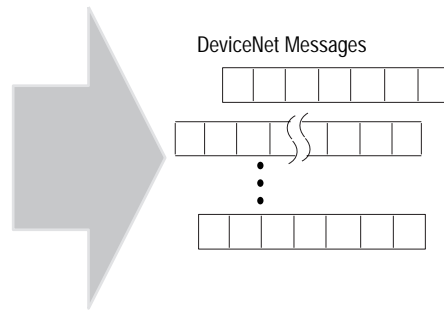

Each individual block transfer is independent, but always retrieves the same input bytes from the scanner's input data table. The types of information that a PLC-5 program will upload from the scanner via the BTR are the:

- Device Input Data Table (6 blocks, 62 through 57 words)
- Device Failure Table (1 block, 52 words)
- Device Active Table (1 block, 51 words)

When the scanner receives a BTR, it automatically knows which block of data is desired by the size specified.

You may upload portions of the scanner input table rather than the entire table, to support higher-speed operations. The scanner will interpret any BTR of length 1 through 50 with the words 0 thru 49 of block 62 of the scanner input table. BTRs of sizes 57 through 61 represent full blocks of the table. A BTR of 52 words contains the Device Failure Table. Sizes 53 through 56 are reserved. Size 64 is used for Explicit Message Program Control. For more details on Explicit Message Program Control, refer to page 26.

To reduce block transfer time and increase system performance, use only the words you need.

Use the RSNetWorx for DeviceNet software to map data from a DeviceNet node into the scanner input table. Data from a DeviceNet node can be split and put into as many as four different locations in the scanner input table.

Module Status Register

In the Module Status Register (word 0, block 62), bits 0 through 5 indicate to the PLC-5 the current state of the scanner module. When a Module Command Register command is sent to the scanner module, the respective bits are set in the Module Status Register when the command executes. Depending on network load, the scanner may take several moments to detect network status changes. The bits latch on in the “on” state until the command clears.

Bits 6 and 7 indicate that you should read the device failure table for more specific information about which devices failed. Bits 8 and 9 indicate that you should read the device autoverify table to determine which device has incorrect device keying or a misconfigured data size in the scanner configuration tables. Use the DeviceNetManager software to correct this error.

You can use bits 6 and 7 of the Module Status Register to enable the scanner module’s Module Command Register to react to certain conditions. An example reaction to a condition is to keep the communication ports in the “idle” mode until the bits clear. When the bits clear, this indicates that all devices on the networks are operational. When the devices are operational, you can put the ports in the “run” mode, so that output data goes to the devices.

If a device failure is detected, you can put the communication into the “idle” mode, so that all devices would go into their idle state. You may tie these inputs to the Module Command Register, so that you may use them to adjust the operating mode of the scanner when devices fail or go online at startup.

You can also modify your control logic to run differently to compensate for the loss of communication with a certain node. An alarm message to alert an operator of the problem is also possible.

The following table lists Module Status Register bit numbers and their descriptions.

Module Status Register - Word 0, Block 62				
Bit Number	Bits		Operating Mode	Operating Mode Description
	01	00		
00 - 01	0	0	DeviceNet Channel 1 in idle mode	Idle The scanner does not map output data to the devices, but keeps network connections to devices open so device failures can be detected. Input data is returned from devices, and mapped into the scanner input table and the discrete inputs. Outputs on the network are not under program control and will be in their configured 'safe state.' The scanner must be in this mode to perform configuration of the scanner database tables.
	0	1	DeviceNet Channel 1 in run mode	
	1	0	DeviceNet Channel 1 in fault mode	
	1	1	Reserved	
02 - 03	0	0	DeviceNet Channel 2 in idle mode	Run The scanner module maps output data from its scanner output table and discrete outputs to each device on the network. Inputs are received and mapped into the scanner input table and discrete inputs. Outputs on the network are under program control.
	0	1	DeviceNet Channel 2 in run mode	
	1	0	DeviceNet Channel 2 in fault mode	
	1	1	Reserved	
04	0	0	Enable DeviceNet Channel 1	Placing the PLC-5 into the PROG or REM_PROG mode places the scanner into IDLE MODE regardless of the state of the bits in the module command register. Placing the PLC-5 into RUN or REM_RUN mode causes the state of the bits in the module command register to determine the scanner state.
	1	1	Disable DeviceNet Channel 1	
05	0	0	Enable DeviceNet Channel 2	Fault The scanner has stopped communicating with devices on the network. No outputs or inputs are mapped. Outputs on the network are not under program control. If the scanner was in run, devices will go to their fault state.
	1	1	Disable DeviceNet Channel 2	
06	0	0	No failures detected	Device Failure One or more of the devices in the scanner's scan list has failed to communicate with the scanner.
	1	1	DeviceNet Channel 1 device failure detected	
07	0	0	No failures detected	Autoverify Failure One or more of the devices in the scanner's scan list is returning an incorrect number of bytes of data in response to a strobe/poll, according to the information stored in the scanner's scan list.
	1	1	DeviceNet Channel 2 device failure detected	
08	0	0	No failures detected	Communications Failure There is no communication on the port.
	1	1	DeviceNet Channel 1 autoverify failure detected	
09	0	0	No failures detected	Duplicate Node Address Failure There is another node with the same address on the network.
	1	1	DeviceNet Channel 2 autoverify failure detected	
10	0	0	No failures detected	Scanner Configuration Missing or Corrupted Either the I/O chassis addressing mode is set to an illegal position or, the chassis addressing mode switch does not match the value stored in the scanner's scan list.
	1	1	DeviceNet Channel 1 communications failure detected	
11	0	0	No failures detected	Client/server transaction response queued The client/server response is loaded and available with a 64-word Block Transfer Read.
	1	1	DeviceNet Channel 2 communications failure detected	
12	0	0	No failures detected	
	1	1	DeviceNet Channel 1 duplicate node address failure	
13	0	0	No failures detected	
	1	1	DeviceNet Channel 2 duplicate node address failure	
14	0	0	No failures detected	
	1	1	Scanner configuration missing or corrupted	
15	0	0	No failures detected	
	1	1	Client/server transaction response queued	

Device Active Table

The Device Active Table is located in words 0–7 of a 51 word BTR. The scanner assigns one bit of the first 128 bits to each device on the networks. The scanner assigns one bit to consecutive Device Addresses.

Devices on Channel 1 are indicated by a single bit in consecutive order in words 0–3. Devices on Channel 2 are indicated by a single bit in consecutive order in words 4–7.

If a bit is set, it indicates that the node is in the scanner's scan list and has successfully communicated with the scanner. These bits are not cleared if the slave node goes off-line. The bits are cleared by resetting the scanner.

Device Failure Table

The scanner maintains one Device Failure Table accessed with a 52-word BTR. The table consists of:

- **Communications Failure Bitmap** – the scanner tracks device failures in its scan list by assigning one bit of the first 128 bits in the table to each device on the networks. The scanner assigns one bit to consecutive Device Addresses. Devices on Channel 1 are indicated by a single bit in consecutive order in words 0–3. Devices on Channel 2 are indicated by the bits in words 4–7. If a bit is set, it indicates that the node is in the scanner's scan list and is either not present, not communicating or failed autoverify.
- **Autoverify Failure Bitmap** – the scanner tracks autoverify failures by assigning one bit of the second 128 bits in the table to each device on the networks. A value of 1 in the bit position indicates a failure is detected and a value of 0 indicates normal operation. The scanner assigns one bit to consecutive Device Addresses. Devices on Channel 1 are indicated by a single bit in consecutive order in words 8–11. Devices on Channel 2 are indicated by the bits in words 12–15. If a bit is set, it indicates that the device is returning device keying or a data size that does not match the keying or data size in the scanner configuration table.
- **DeviceNet 1 Scan Counter (word 16)** – the scanner increments a one-word counter whenever a scan of the DeviceNet 1 devices is completed. The counter rolls over when it reaches its maximum value.

- DeviceNet 2 Scan Counter (word 17) – the scanner increments a one-word counter whenever a scan of the DeviceNet 2 devices is completed. The counter rolls over when it reaches its maximum value.
- Device Idle State Bitmap (words 18–25, 4 words for Channel 1, four words for Channel 2) – the scanner assigns one bit to consecutive Device Addresses. Devices on Channel 1 are indicated by a single bit in consecutive order in words 18–21. Devices on Channel 2 are indicated by the bits in words 22–25. If a bit is set, it indicates that the scanner received a valid DeviceNet idle indication from this node. A device in idle mode does not return updated I/O data to the scanner because the device is not in its run mode.
- Node Address/Status Indicator (word 26) -- Channel 1 and Channel 2 node address and scanner diagnostic information is copied to the low and high bytes of Word 26, respectively. The descriptions of these codes are listed on page 36.
- 25 words of pad data (zeroes, words 27–51), to complete the table for a total of 52 words.

Configure Your Module for the DeviceNet Network

To operate your 1771-SDN Scanner Module, you must configure the two tables listed below, using RSNetworx for DeviceNet software. For additional information, refer to your RSNetworx documentation or online help and your 1771-SDN Scanner Configuration Manual (publication number 1771-UM118C-EN-P).

Configure this table:	To:
Scanner Configuration Table	Control how the scanner gathers DeviceNet messages. The information you configure for this table includes: <ul style="list-style-type: none"> • frequency of background poll messages on each DeviceNet channel • DeviceNet port disable/enable
Scan List Table	Use the information gathered from the scan list table to map the I/O data between the scanner's I/O data table and DeviceNet nodes. A device must have a configuration table entry in the scanner's database before its I/O messages are mapped to the PLC. The information you configure for this table includes: <ul style="list-style-type: none"> • the size of data in each node's DeviceNet messages • location of a device's data in the data tables that are transferred to and from the PLC

Clear the Scanner Module's Scan List

To clear the scanner module's scan list, follow these procedures:

1. Remove power from the I/O chassis.

WARNING

If you insert or remove the scanner module with power applied to this module or any device on the network, an electrical arc can occur. This could cause an explosion in hazardous location installations. Be sure that power is removed or the area is nonhazardous before proceeding.

2. Remove the scanner module from the I/O chassis
3. In the Configuration switchbank, set switch 6 to the on or "1" position.
4. Reinstall the scanner module and apply chassis power.
5. Wait for the Module Status indicator to flash red.
6. Remove power from the I/O chassis.

WARNING

If you insert or remove the scanner module with power applied to this module or any device on the network, an electrical arc can occur. This could cause an explosion in hazardous location installations. Be sure that power is removed or the area is nonhazardous before proceeding.

7. Remove the scanner module from the I/O chassis.
8. In the Configuration switchbank, set switch 6 to the off or "0" position.
9. Insert scanner module into the I/O chassis and apply power.

Use the Explicit Message Program Control Feature

Use the Explicit Message Program Control feature to configure device parameters on your DeviceNet network via the ladder logic program in the PLC-5 processor that is controlling these devices.

Use the Explicit Message Program Control feature to:

- transmit configuration data from your scanner module to its slave devices on your DeviceNet network
- receive status and diagnostics from these devices on your DeviceNet network
- make runtime adjustments to device parameters according to changing conditions detected by your processor

How the Explicit Message Program Control Feature Works

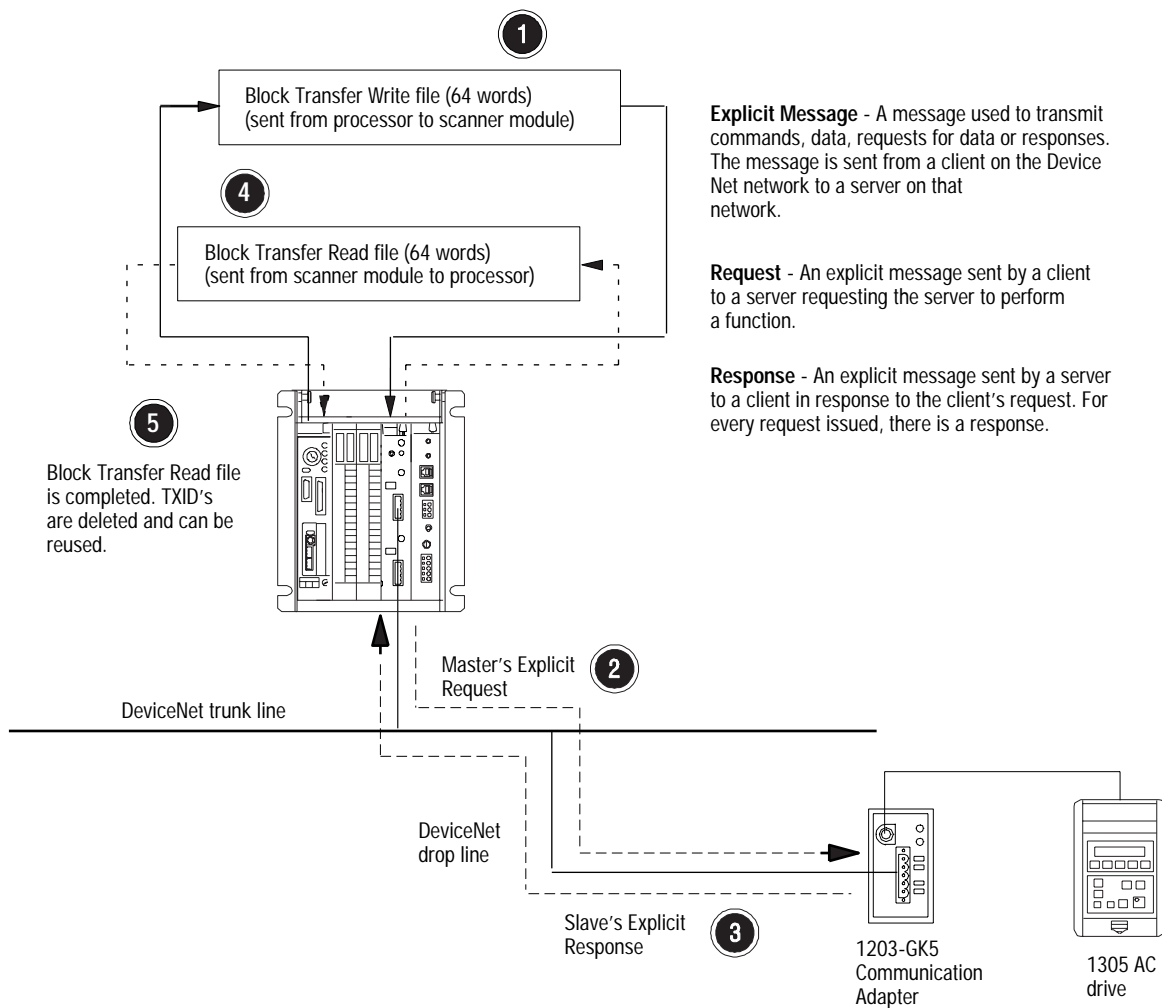

1. Format a Block Transfer Write file in the processor to send an Explicit Message Request to the scanner module (**download**).

2. The scanner module transmits the Explicit Message Request to the slave device over the DeviceNet network.
3. The slave device transmits the Explicit Message Response back to the scanner and is queued into a block transfer buffer.
4. The processor uses a Block Transfer Read file to retrieve the Explicit Message Response from the scanner's buffer (**upload**).
5. The Block Transfer Read file is completed. The transaction IDs are deleted and can be reused.

The scanner module requires a precisely-formatted block transfer read and write size of 64 words. The Explicit Message Control table in the scanner module is 64 words. The scanner module uses the block transfer size as an indicator that the content is a client/server request.

How to Format the Explicit Message Transaction Block

Ten 32-word transaction blocks within the scanner module are reserved for Explicit Message Program Control. The transaction blocks accommodate both the download of Explicit Message Requests and the upload of Explicit Message Responses.

The scanner module can accommodate one request or response for each transaction block and can transfer two blocks for each upload and download. You must format each transaction block as shown in the following figure:

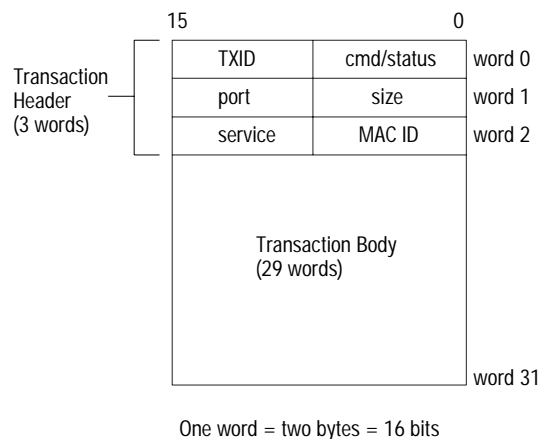

The transaction block is divided into two parts:

- **transaction header** – contains information that identifies the transaction to the scanner and processor
- **transaction body** – in a request, this contains the DeviceNet Class, Instance, Attribute and Service Data portion of the transaction. In a response, this contains only the response message.

Each of the data attributes in the transaction header are one byte in length:

- **command/status** – for each download, you assign a command code to instruct the scanner how to administer the request:

Command Code	Description
0	Ignore transaction block (block empty)
1	Execute this transaction block
2	Get status of transaction TXID
3	Reset all client/server transactions
4-255	Reserved

For each upload, the status code provides the processor with status on the device and its response:

Status Code	Description
0	Ignore transaction block (block empty)
1	Transaction completed successfully
2	Transaction in progress (not ready)
3	Error – slave not in scan list
4	Error – slave offline
5	Error – DeviceNet port disabled/offline
6	Error – transaction TXID unknown
7	Error – slave not responding to request
8	Error – Invalid command code
9	Error – Scanner out of buffers
10	Error – Other Client/server transaction in progress
11	Error – could not connect to slave device
12	Error – response data too large for block
13	Error – invalid port
14	Error – invalid size specified
15	Error – connection busy
16-255	Reserved

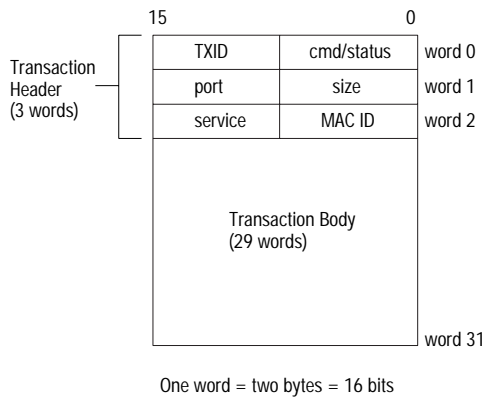

- TXID (transaction ID)** – when you create and download a request to the scanner, the processor’s ladder logic program assigns a TXID to the transaction. This is a one-byte integer in the range of 1 to 255. The scanner uses this value to track the transaction to completion, and returns the value with the response that matches the request downloaded by the processor. The ladder logic program monitors rollover and usage of TXID values.
- size** – the size of the transaction body in bytes. The transaction body can be as many as 29 words (58 bytes) in length. If the size exceeds 29 words, an error code will be returned.
- port** – the DeviceNet port where the transaction is routed. The port can be zero (Channel 1) or one (Channel 2).
- MAC ID (node address)** – the DeviceNet network address of the slave device where the transaction is sent. This value can range from 0 to 63. The port and MAC ID attributes coupled together identify the target slave device.
- service** – for each Explicit Message Request and Response, the service attribute contains the service request and response codes that match the corresponding request for the TXID.

The following figure describes the format and mapping of transaction blocks for request and response messages in the scanner module:

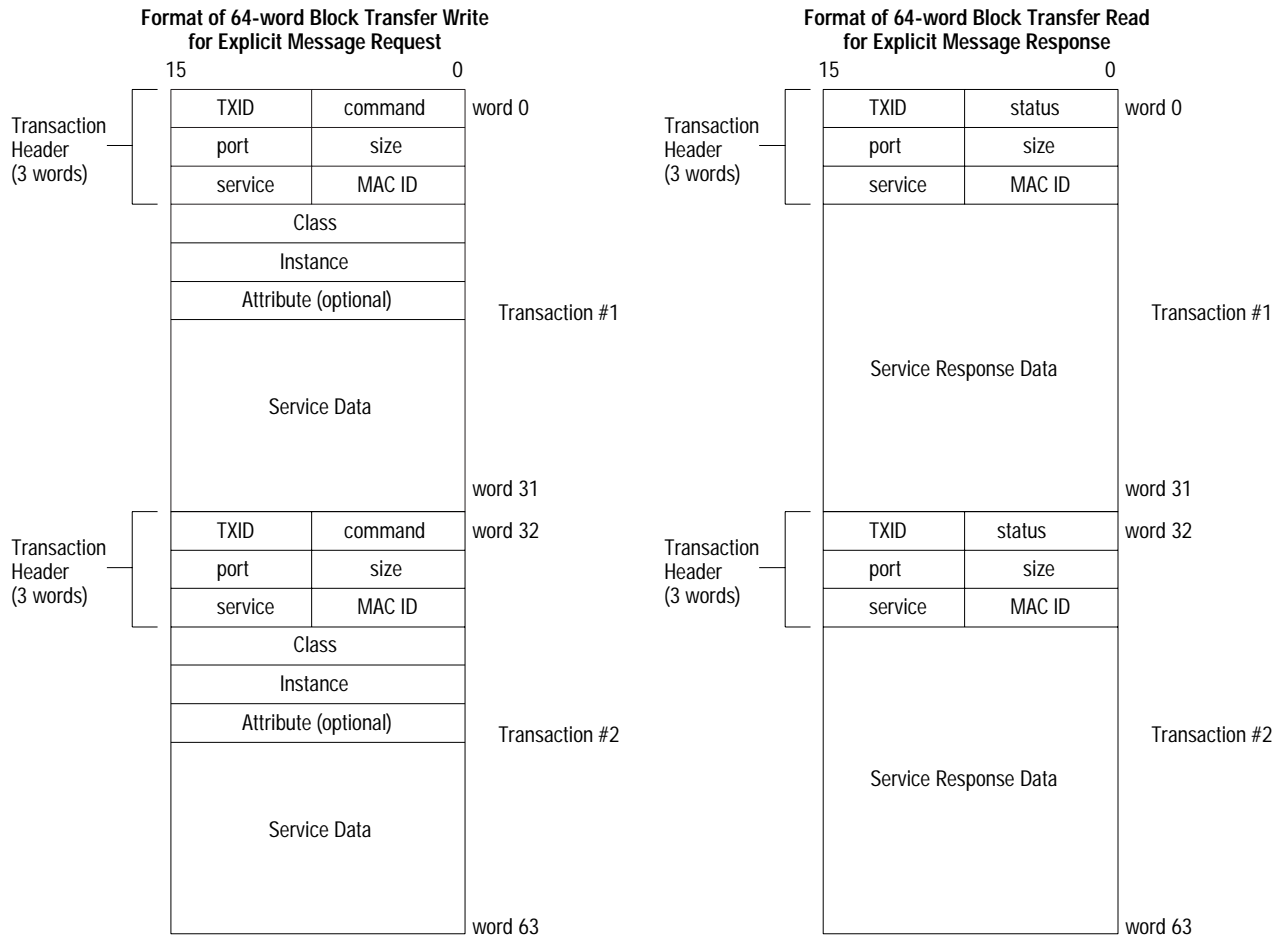

How the Processor and Scanner Module Manage Messages

Block transfer operations between the processor and the scanner always originate in the processor. The scanner module can only wait for the processor to download a transaction block to the module or request an upload of a transaction block from the module.

Once an Explicit Message Request transaction block is downloaded to the scanner module, a ladder logic program in the processor polls the scanner module for the transaction block containing the Explicit Message Response for that request. This is done by the processor with a Block Transfer Read on the scanner module.

Depending on the network load, the scanner could take a few seconds to complete the request. When a response is loaded, bit 15 of the module status register is set to 1. The program may have to poll the scanner module a number of times before the scanner returns a Response Transaction Block.

The scanner module recognizes I/O data and control as higher priorities over explicit messaging on DeviceNet.

Message lengths and slave device types impact transaction message completion times. If the processor has queued multiple Explicit Message Transactions to the scanner module for multiple slave devices, the transactions with the slaves may not complete in the order in which the requests were received. The slave responses are queued to the 64 word Block Transfer Read in the order in which they are received. As response transaction blocks are uploaded, the processor's program matches the responses to the requests using the TXID field.

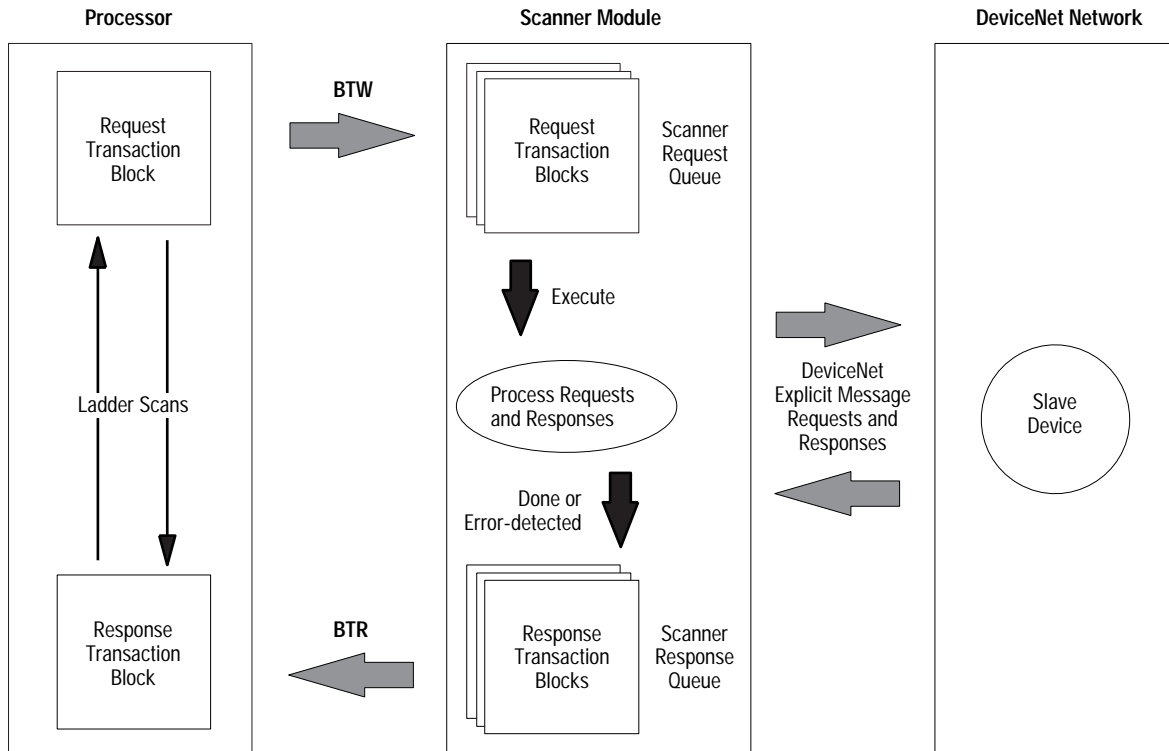

Explicit Message Program Control Limitations

- The processor is always the DeviceNet client and the slave is always the DeviceNet server.
- A maximum of **ten** Explicit Message Request Transaction Blocks with the execute command can be queued to the scanner module at any time. For example, **five** Block Transfer Write files containing two transactions each, can be performed at any time. The scanner module receives and deletes any additional client/server requests with the execute command over the maximum of **ten**.

As transactions are removed from the queue and response transaction blocks are returned to the processor, additional transaction blocks can be issued in their place, as long as the total does not exceed ten.

- The scanner module supports **two** transaction blocks per upload and download.
- If a slave device is not communicating at the time the scanner module processes its Request Transaction Block, the scanner module will return an error status for that transaction.
- At a minimum, the scanner module supports the following DeviceNet services in Request Transaction Blocks:

Service Name:	Service Code:	Example:
Get_Attribute_Single	0E _{hex}	Upload a single parameter value from a device
Set_Attribute_Single	10 _{hex}	Download a single parameter value to a device
Get_Attribute_All	01 _{hex}	Upload all parameter values from a device
Set_Attribute_All	02 _{hex}	Download all parameter values to a device

- Continuous Block Transfers of 64 words are not supported.
- All transaction blocks are processed, therefore, any unused transaction blocks must be left blank.
- Client/Server commands and requests with transaction IDs that are in use are deleted by the scanner module.

- If a slave device returns a DeviceNet error in response to the request downloaded from the processor, the scanner recognizes the error as a successful transaction (status code =1).

A failure to respond to the request within the number of retries or timeout period specified for the Explicit Message Connection is recognized by the scanner module as an error. The error code is returned in the status attribute of the transaction header.

Explicit Messaging Error Codes

Error codes have two bytes of data. The first byte is a General Error Code and the second is an optional Additional Code Field that may contain additional information about the error. If this field is unused, the value 0FFH is shown. The following table describes explicit messaging error codes.

Numeric Code:	Name:	Description:
02H	Resource unavailable	A needed resource was not available
08H	Service unsupported	Service is not defined or implemented for this class/instance
09H	Invalid attribute value	Data is invalid for the specified attribute
0BH	Already in requested state	Object is in the requested state - redundant request
0CH	Object state conflict	Not allowed with object in present state
0EH	Attribute cannot be set	Read-only attribute
0FH	Privilege violation	A permission/privilege check failed
10H	Device state conflict	Not allowed with device in present state
11H	Reply too big	Reply larger than buffer allocated when connection was established
13H	Too little data	Request included insufficient data
14H	Attribute not supported	Attribute number is incorrect
15H	Too much data	Request included extra data
16H	Object does not exist	Class/instance numbers are incorrect
18H	No stored attribute data	Attribute data was not saved prior to this request
19H	Store operation failure	Attribute data was not successfully saved
1FH	Vendor-specific error	Second byte may offer details - refer to vendor documentation
20H	Invalid parameter	Parameter associated with request is invalid
D0H	Reserved and service-specific errors	Used only when none of the standard error codes supplemented by the second byte accurately describes the problem.
FFH		

Troubleshoot Your Module

The bicolor (green/red) module status indicator displays device status. It indicates whether the device has power and is functioning properly.

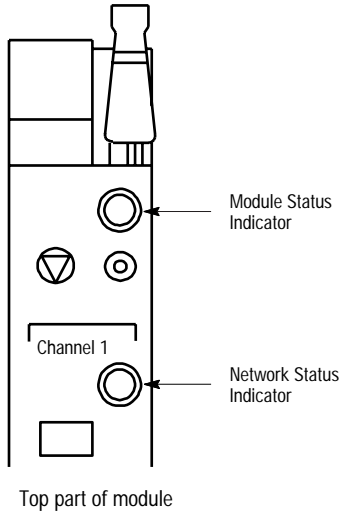

If your indicator is:	Then:	Take this action:
Off	There is no power applied to the module.	Verify power connections and apply power.
Green	The module is operating normally.	Do nothing.
Flashing Green	The module is not configured.	Configure the module.
Flashing Red	There is an invalid configuration.	Verify module switch settings. Check configuration setup.
Red	The module has an unrecoverable fault.	Replace the module.

Channels 1 and 2 each have a bicolor (green/red) network status indicator. The following table provides troubleshooting information about the Channel 1 and 2 communication links.

If the indicator is	Then	Which indicates	Take this action
Off	The device has no power or the channel is disabled for communication due to a bus off condition, loss of network power, or it has been intentionally disabled.	The channel is disabled for DeviceNet communication.	Power-up the module, provide network power to the channel, and be sure the channel is enabled in both the module configuration table and the module command word.
Green	Normal operation.	All slave devices in the scanlist table are communicating normally with the module.	None.
Flashing Green	The two-digit numeric display for the channel indicates an error code that provides more information about the condition of the channel.	The channel is enabled but no communication is occurring.	Configure the scanlist table for the channel to add devices.
Flashing Red	The two-digit numeric display for the channel displays an error code that provides more information about the condition of the channel.	At least one of the slave devices in the module's scanlist table has failed to communicate with the module. The network has faulted.	Examine the failed device and the scanlist table for accuracy.
Red	The communications channel has failed. The two digit numeric display for the channel displays an error code that provides more information about the condition of the channel.	The module may be defective.	Reset the module. If failures continue, replace module.

Your 1771-SDN Scanner Module has a node address/status indicator that uses numeric displays to indicate diagnostic information about your module. The display flashes at approximately 1 second intervals, depending on network traffic. The following table summarizes the meanings of the numeric codes.

Top part of module

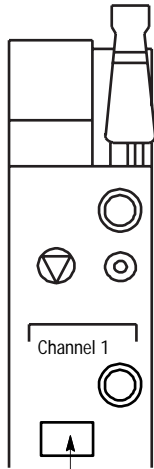

Node Address / Status Indicator

Numeric Code	Description	Take this action
0 - 63	Normal operation. The numeric display indicates the 1771-SDN's node address on the DeviceNet network.	None.
70	Module failed Duplicate Node Address check.	Change the module channel address to another available one. The node address you selected is already in use on that channel.
71	Illegal data in scan list table (node number alternately flashes).	Reconfigure the scan list table and remove any illegal data.
72	Slave device stopped communicating (node number alternately flashes).	Inspect the field devices and verify connections.
73	Device's identity information does not match electronic key in scan list table entry.	Verify that the correct device is at this node number. Make sure that the device at the scrolling node address matches the desired electronic key (vendor, product code, product type, etc.).
74	Data overrun on port detected.	Modify your configuration and check for invalid data. Check network communication traffic.
75	No traffic from other modules detected on the network.	Check the network configuration. (Scanlist may be empty.)
76	No direct network traffic for module detected.	None. The module hears other network communication.
77	Data size expected by the device does not match scan list entry.	Reconfigure your module for the correct transmit and receive data sizes.
78	Slave device in scan list table does not exist.	Add the device to the network, or delete the scan list entry for that device.
79	Module has failed to transmit a message.	Make sure that your module is connected to a valid network. Check for disconnected cables.
80	Module is in IDLE mode.	Put controller in RUN mode. Enable RUN bit in module command register.
81	Module is in FAULT mode.	Check Module Command Register for fault bit set.
82	Error detected in sequence of fragmented I/O messages from device.	Check scan list table entry for slave device to make sure that input and output data lengths are correct. Check slave device configuration.
83	Slave device is returning error responses when module attempts to communicate with it.	Check accuracy of scan list table entry. Check slave device configuration. Slave device may be in another master's scan list. Reboot slave device.
84	Module is initializing the DeviceNet network.	None. This code clears itself once module attempts to initialize all slave devices on the network.

Numeric Code	Description	Take this action
85	Data size was incorrect for this device at runtime.	<ul style="list-style-type: none"> • Slave device is transmitting incorrect length data. • Verify device is not configured for variable poll connection size. • Try replacing the device.
86	Device is producing zero length data (idle state) while module is in Run Mode.	Check device configuration and slave node status.
87	The primary owner has not allocated the slave.	Put the primary owner on line.
88	The connection choices (polled, strobed, etc.) between the primary connection and the shared input only connection do not match.	Reconfigure the shared input only connection's choice(s) to be the same as, or a subset of, the primary connection's choice(s).
89	Slave device initialization using Auto Device Replacement parameters failed.	<ul style="list-style-type: none"> • Put the slave device into configurable mode. • Check the slave's EDS file, if the slave is configured offline. • Check to see if the slave device has been replaced with an incompatible device.
90	User has disabled communication port.	Check Module Command Register for DISABLE bit set.
91	Bus-off condition detected on comm port. Module is detecting communication errors.	Check DeviceNet connections and physical media integrity. Check system for failed slave devices or other possible sources of network interference.
92	No network power detected on communication port.	Provide network power. Make sure that module drop cable is providing network power to module comm port.
95	Application FLASH update in progress.	None. Do not disconnect the module while application FLASH is in progress. You will lose any existing data in the module's memory.
97	Module operation halted by user command.	Check Module Command Register for HALT bit set.
98	Unrecoverable firmware failure.	Service or replace your module.
99	Unrecoverable hardware failure.	Service or replace your module.

The following information applies when operating this equipment in hazardous locations:

Products marked "CL I, DIV 2, GP A, B, C, D" are suitable for use in Class I Division 2 Groups A, B, C, D, Hazardous Locations and nonhazardous locations only. Each product is supplied with markings on the rating nameplate indicating the hazardous location temperature code. When combining products within a system, the most adverse temperature code (lowest "T" number) may be used to help determine the overall temperature code of the system. Combinations of equipment in your system are subject to investigation by the local Authority Having Jurisdiction at the time of installation.

Informations sur l'utilisation de cet équipement en environnements dangereux :

Les produits marqués "CL I, DIV 2, GP A, B, C, D" ne conviennent qu'à une utilisation en environnements de Classe I Division 2 Groupes A, B, C, D dangereux et non dangereux. Chaque produit est livré avec des marquages sur sa plaque d'identification qui indiquent le code de température pour les environnements dangereux. Lorsque plusieurs produits sont combinés dans un système, le code de température le plus défavorable (code de température le plus faible) peut être utilisé pour déterminer le code de température global du système. Les combinaisons d'équipements dans le système sont sujettes à inspection par les autorités locales qualifiées au moment de l'installation.

WARNING

EXPLOSION HAZARD

- Do not disconnect equipment unless power has been removed or the area is known to be nonhazardous.
- Do not disconnect connections to this equipment unless power has been removed or the area is known to be nonhazardous. Secure any external connections that mate to this equipment by using screws, sliding latches, threaded connectors, or other means provided with this product.
- Substitution of components may impair suitability for Class I, Division 2.
- If this product contains batteries, they must only be changed in an area known to be nonhazardous.

AVERTISSEMENT

RISQUE D'EXPLOSION

- Couper le courant ou s'assurer que l'environnement est classé non dangereux avant de débrancher l'équipement.
 - Couper le courant ou s'assurer que l'environnement est classé non dangereux avant de débrancher les connecteurs. Fixer tous les connecteurs externes reliés à cet équipement à l'aide de vis, loquets coulissants, connecteurs filetés ou autres moyens fournis avec ce produit.
 - La substitution de composants peut rendre cet équipement inadapté à une utilisation en environnement de Classe I, Division 2.
 - S'assurer que l'environnement est classé non dangereux avant de changer les piles.
-

Specifications

Module Location	1771-A1B through -A4B or later I/O chassis
Module Defaults	Node Address – 63 Baud Rate – 125 Kbits/s
Power Consumption - Backplane Current - DeviceNet ¹	5Vdc, 0.8A 24Vdc, 50mA per channel Class 2
Isolation Voltage	Optical Isolation between backplane and DeviceNet channel, tested to withstand 500Vac for 60 seconds 1 Megohm resistor from DeviceNet channel to chassis
Operating Temperature	IEC 60068-2-1 (Test Ad, Operating Cold), IEC 60068-2-2 (Test Bd, Operating Dry Heat), IEC 60068-2-14 (Test Nb, Operating Thermal Shock): 0-60°C (32–140°F)
Storage Temperature	IEC 60068-2-1 (Test Ab, Un-packaged Non-operating Cold), IEC 60068-2-2 (Test Bc, Un-packaged Non-operating Dry Heat), IEC 60068-2-14 (Test Na, Un-packaged Non-operating Thermal Shock): –40 to 85°C (–40 to 185°F)
Relative Humidity	IEC 60068-2-30 (Test Db, Un-packaged Non-operating Damp Heat): 5–95% non condensing
Vibration	IEC60068-2-6 (Test Fc, Operating): 2g @10–500Hz
Shock	IEC60068-2-27:1987, Test Ea (Unpackaged shock, ES#002) Operating - 30g Non-operating - 50g
Emissions	CISPR 11: Group 1, Class A
ESD Immunity	IEC 61000-4-2: 4kV contact discharges
Radiated RF Immunity	IEC 61000-4-3: 10V/m, 3V/m Broadcast Bands, with 1kHz sine-wave 80% AM from 30MHz to 1000Mhz
EFT/B Immunity	IEC 61000-4-4: ±2kV at 5kHz on communications ports
Surge Transient Immunity	IEC 61000-4-5: ±2kV line-earth(CM) on signal ports
Conducted RF Immunity	IEC 61000-4-6: 10Vrms with 1kHz sine-wave 80%AM from 150kHz to 30MHz
Enclosure Type Rating	None (open style)
Wiring - Type - Category ²	1771-CD 2
10-pin Linear Plug - Torque - Catalog Number	5-7 pound-inches 1787-PLUG10R
Dimesions (HxWxD)	270 x 30 x 170mm (10.6 x 1.2 x 6.7 inches)
Weight	0.9kg (1.9lb)

¹To remain compliant with UL/CSA certification, the DeviceNet power supply must meet NEC Class 2 requirements.

²Use this conductor category information for planning conductor routing as described in publication 1770-4.1, *Industrial Automation Wiring and Grounding Guidelines*.

Specifications continued on back page

Specifications - Continued

Certifications (when product is marked)	cUL _{US}	UL Listed Industrial Control Equipment. Certified for US and Canada
	cUL _{US}	UL Listed for Class I, Division 2 Groups A, B, C, D Hazardous Locations. Certified for US and Canada
	CE ³	European Union 89/336/EEC EMC Directive, compliant with: EN 50081-2; Industrial Emissions EN 50082-2; Industrial Immunity European Union 73/23/EEC LVD Directive, compliant with: EN 61131-2; Programmable Controllers
	C-Tick ³	Australian Radiocommunications Act, compliant with: AS/NZS 2064; Industrial Emissions
	ODVA	ODVA conformance tested to ODVA DeviceNet specifications
User Manual	1771-6.5.132	

¹To remain compliant with UL/CSA certification, the DeviceNet power supply must meet NEC Class 2 requirements.

²Use this conductor category information for planning conductor routing as described in publication 1770-4.1, *Industrial Automation Wiring and Grounding Guidelines*.

³See the Product Certification link at www.ab.com for Declarations of Conformity, Certificates, and other certification details.

PLC, PLC-2, PLC-3, PLC-5 and RSLogix 5, RSNetWorx for DeviceNet and RSLinx are trademarks of Rockwell Automation.

DeviceNet is a trademark of the Open DeviceNet Vendor Association.

Windows is a trademark of Microsoft Corporation.

Reach us now at www.rockwellautomation.com

Wherever you need us, Rockwell Automation brings together leading brands in industrial automation including Allen-Bradley controls, Reliance Electric power transmission products, Dodge mechanical power transmission components, and Rockwell Software. Rockwell Automation's unique, flexible approach to helping customers achieve a competitive advantage is supported by thousands of authorized partners, distributors and system integrators around the world.

Americas Headquarters, 1201 South Second Street, Milwaukee, WI 53204, USA, Tel: (1) 414 382-2000, Fax: (1) 414 382-4444

European Headquarters SA/NV, avenue Herrmann Debroux, 46, 1160 Brussels, Belgium, Tel: (32) 2 663 06 00, Fax: (32) 2 663 06 40

Asia Pacific Headquarters, 27/F Citicorp Centre, 18 Whitfield Road, Causeway Bay, Hong Kong, Tel: (852) 2887 4788, Fax: (852) 2508 1846

Publication 1771-IN014B-EN-P - September 2001

Supersedes Publication 1771-5.14 - July 1997



Rockwell Automation

PN 957491-03

© 2001 Rockwell International Corporation. Printed in the U.S.A.