

High-Performance Process Manager Planning

HP02-500

System Site Planning - 2

***High-Performance
Process Manager
Planning***

**HP02-500
Release 530
CE Compliant
3/98**

Copyright, Notices, and Trademarks

© Copyright 1995 - 1998 by Honeywell Inc.

Revision 05 – March 20, 1998

While this information is presented in good faith and believed to be accurate, Honeywell disclaims the implied warranties of merchantability and fitness for a particular purpose and makes no express warranties except as may be stated in its written agreement with and for its customer.

In no event is Honeywell liable to anyone for any indirect, special or consequential damages. The information and specifications in this document are subject to change without notice.

TotalPlant, TDC 3000, Process Manager, and SMARTLINE are U.S. registered trademarks of Honeywell Inc.

Honeywell
Industrial Automation and Control
Automation College
2820 West Kelton Lane
Phoenix, AZ 85023
1-800-852-3211

About This Publication

This manual provides information necessary to properly plan the installation of a High-Performance Process Manager (HPM) subsystem at a TPS system site. The subsystem encompasses the High-Performance Process Manager and the Network Interface Module (NIM), which is resident on the Universal Control Network (UCN), a network associated with the TPS system Local Control Network (LCN). The amount of information that this publication provides depends on your personal experience and the process that the High-Performance Process Manager will control and monitor.

The experienced planner, a person involved in the installation of TPS system's Basic or LCN equipment, will find that some information is familiar. However, regardless of your past experience, you must read Section 4 in this manual to enhance your knowledge of the process control connections available, and also reference the *TPS System Site Planning, Universal Control Network Planning, and Universal Control Network Installation* manuals to prepare yourself for the connection of the High-Performance Process Manager to the Universal Control Network.

In some cases, control room expansion will be part of installing the High-Performance Process Manager. If this is the case, use the *LCN Planning* and *LCN Installation* manuals to plan for expansion of the network.

This publication supports **TotalPlant** Solution (TPS) system network software Release 530 or earlier software releases. TPS is the evolution of TDC 3000^X.

The publication supports CE Compliant equipment. Any equipment designated as "CE Compliant" complies with the European Union EMC and its health and safety directives. All equipment entering the European countries after January 1, 1996 require this type of compliance, denoted by the "CE Mark."

Standard Symbols

Scope

The standard symbols used in this publication are defined as follows.

ATTENTION

Notes inform the reader about information that is required, but not immediately evident.

CAUTION

Cautions tell the user that damage may occur to equipment if proper care is not exercised.

WARNING

Warnings tell the reader that potential personal harm or serious economic loss may happen if instructions are not followed.

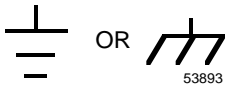

Ground connection to building safety ground.

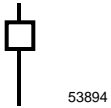

Ground stake for building safety ground.



Electrical Shock Hazard—can be lethal.



Electrical Shock Hazard—can be lethal.

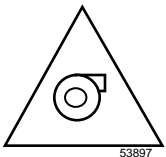

Rotating Fan—can cause personal injury.

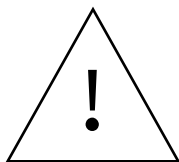

Caution—refer to the appropriate installation document.

Table of Contents

SECTION 1 – INTRODUCTION.....	1
1.1 Overview.....	1
SECTION 2 – HPM DESCRIPTION.....	3
2.1 Overview.....	3
2.2 Card Files.....	5
2.2.1 HPMM Card Files.....	6
2.2.2 Input/Output Processor (IOP) Card Files.....	12
2.3 Input/Output Processor (IOP) Cards.....	16
2.3.1 IOP Redundancy.....	17
2.4 I/O Link Extender (Fiber Optic Link).....	19
2.5 Field Termination Assemblies (FTAs).....	24
2.6 Power Systems.....	36
2.7 Cabinet Configurations.....	41
SECTION 3 – POWER REQUIREMENTS.....	45
3.1 Overview.....	45
3.2 Backup Strategy.....	46
3.3 Quality.....	48
3.4 Power Draw.....	51
3.4.1 Typical 24 Vdc Power Draw Calculations.....	53
3.4.2 Single Power System Calculation Example.....	58
3.4.3 Dual Power System Calculation Example.....	59
3.4.4 HPM AC Power Draw.....	60
3.4.5 Crest Factor.....	61
3.4.6 Inrush Current.....	62
3.5 Substation Sizing.....	64
3.6 Circuit Breaker Sizing.....	65
3.7 Custom UPS and Power Factor.....	66
3.8 Automatic Bypass Switch.....	66
3.9 Surge Protection.....	67
3.10 Grounded Conductor.....	68
3.11 Redundant Safety Grounds.....	68
3.12 Emergency Shutdown.....	68
3.13 Trays and Conduits.....	68
3.14 Existing TPS System AC Power.....	69
SECTION 4 – PROCESS WIRING.....	71
4.1 Overview.....	71
4.2 FTA Selection.....	72
4.3 Cabinet Entry.....	80
4.4 Signal Tray Wiring Compatibility.....	81
4.5 Process Wiring Termination.....	82
SECTION 5 – HAZARDOUS ENVIRONMENT PLANNING.....	83
5.1 Overview.....	83
5.2 Hazardous Area Classifications.....	84
5.3 Mounting and Operating the HPM in a Division 2 Location.....	86
5.4 Field Wiring in Hazardous Locations.....	100
SECTION 6 – CORROSION PROTECTION PLANNING.....	103
6.1 Overview.....	103
6.2 Model Numbers.....	106

Table of Contents

SECTION 7 – CE COMPLIANCE	115	
7.1	Overview	115
7.2	Card Files	116
7.3	HPMM Cards	117
7.4	IOPs	117
7.5	FTAs	120
7.6	I/O Link Extender	129
7.7	IOP to FTA Cables	130
7.8	Power Cables	131
7.9	I/O Link Interface Cables	136
7.10	UCN Trunk Cable Taps	137
7.11	Cabinets	139
SECTION 8 – MODEL MU-CBSM01/MU-CBDM01 CABINETS	141	
8.1	Overview	141
8.2	Cabinet Description	144
8.3	Card File and Power System Configurations	148
8.4	Card File and Power System Description	150
8.5	FTA Mounting Channel Description	154
8.5.1	Vertical FTA Mounting Channels	155
8.5.2	Horizontal FTA Mounting Channel	159
8.6	Cabinet Floor Planning	163
SECTION 9 – MODEL MU-CBSX01/MU-CBDX01 CABINETS	165	
9.1	Overview	165
9.2	Cabinet Description	169
9.3	Card File and Power System Configurations	173
9.4	Card File and Power System Description	175
9.5	FTA Mounting Channel Descriptions	179
9.5.1	Vertical FTA Mounting Channels	180
9.5.2	Horizontal FTA Mounting Channel	184
9.6	Cabinet Floor Planning	188
SECTION 10 – REDUNDANCY PLANNING	189	
10.1	Overview	189
10.2	Redundant HPMM Configurations	189
10.3	Redundant IOP Placement	194
10.4	Redundancy Support	195
10.4.1	Power System	195
10.4.2	HPMM to I/O	195

Table of Contents

SECTION 11 – I/O LINK EXTENDER PLANNING.....	197
11.1	Overview..... 197
11.2	Description..... 198
11.3	Fiber Optic Cable Routing..... 204
11.3.1	Direct Burial..... 204
11.3.2	Aerial Lashing..... 204
11.3.3	Vertical Installations..... 205
11.3.4	Indoor Requirements..... 205
11.3.5	Loose Buffered Cable..... 205
11.3.6	Number of Fibers..... 206
11.3.7	Cable Installation..... 206
11.4	Indoor Cable Bend Radius..... 207
11.5	Cable Construction..... 207
11.6	Cable Splices and Connections..... 208
11.7	Signal Loss Budget..... 210
11.7.1	Standard I/O Link Extender..... 210
11.7.2	Long Distance I/O Link Extender..... 212
11.8	Power Level Measurement..... 213
SECTION 12 – LOW LEVEL MULTIPLEXER PLANNING.....	215
12.1	Overview..... 215
12.2	LLMux Version..... 216
12.2.1	LLMux Configurations..... 216
12.2.2	LLMux IOP Placement..... 219
12.2.3	LLMux Power Adapter Placement..... 219
12.2.4	LLMux FTA Placement..... 219
12.2.5	Remote CJR Installation..... 222
12.3	RHMUX Version..... 223
12.3.1	RHMUX Configurations..... 223
12.3.2	RHMUX IOP Placement..... 228
12.3.3	RHMUX Power Adapter Placement..... 228
12.3.4	RHMUX FTA Placement..... 228
SECTION 13 – SERIAL DEVICE INTERFACE PLANNING.....	233
13.1	Overview..... 233
13.2	Serial Device Interface Configurations..... 233
13.3	Serial Device Interface IOP Placement..... 235
13.4	Power Adapter Placement..... 235
13.5	IOP to Power Adapter Cabling..... 235
13.6	Serial Device Interface FTA Placement..... 236
13.7	FTA to Power Adapter Cabling..... 236
13.8	FTA Field Cabling..... 238
13.9	Serial Device Interface FTA Models..... 239
SECTION 14 – SERIAL INTERFACE PLANNING.....	241
14.1	Overview..... 241
14.2	Serial Interface Configurations..... 241
14.3	Serial Interface IOP Placement..... 247
14.4	Power Adapter Placement..... 247
14.5	IOP to Power Adapter Cabling..... 247
14.6	Serial Interface FTA Placement..... 248
14.7	FTA to Power Adapter Cabling..... 248
14.8	FTA Field Cabling..... 250
14.9	Serial Interface FTA Models..... 251
14.10	Communications Interface Specifications..... 252

Table of Contents

SECTION 15 – GALVANICALLY ISOLATED FTA PLANNING.....	253
15.1	Overview..... 253
15.2	Description..... 255
15.3	Features..... 264
15.3.1	IOP Redundancy..... 264
15.3.2	Analog and Digital Output Standby Manual Devices..... 264
15.3.3	Auxiliary Inputs/Outputs..... 265
15.3.4	Power Requirements..... 267
15.3.5	Field Wiring Connections..... 268
15.3.6	Ambient Temperature Limits..... 268
15.3.7	FTA Mounting Channels..... 269
15.4	Power Distribution..... 273
15.4.1	Power Distribution Assembly..... 274
15.4.2	Cabling to Power Distribution Assemblies..... 275
15.4.3	Cabling to FTAs..... 275
15.4.4	Power Considerations..... 276
15.5	High Level Analog Input (HLAI) FTAs..... 277
15.5.1	Model MU-GAIH12/MU-GAIH82 FTA..... 277
15.5.1.1	Description..... 277
15.5.1.2	Connectors..... 277
15.5.1.3	Field Wiring Input Signals..... 277
15.5.1.4	Auxiliary Connector Output..... 278
15.5.1.5	Indicators..... 278
15.5.1.6	Current Consumption..... 278
15.5.1.7	Isolation and Safety..... 278
15.5.2	Model MU-GAIH13/MU-GAIH83 FTA..... 279
15.5.2.1	Description..... 279
15.5.2.2	Connectors..... 279
15.5.2.3	Field Wiring Input Signals..... 280
15.5.2.4	Auxiliary Connector Output..... 280
15.5.2.5	Indicators..... 280
15.5.2.6	Hand-Held Communicator..... 281
15.5.2.7	Current Consumption..... 281
15.5.2.8	Isolation and Safety..... 281
15.5.3	Model MU-GAIH14/MU-GAIH84 FTA..... 282
15.5.3.1	Description..... 282
15.5.3.2	Connectors..... 282
15.5.3.3	Field Wiring Input Signals..... 283
15.5.3.4	Auxiliary Connector Output..... 283
15.5.3.5	Indicators..... 283
15.5.3.6	Hand-Held Communicator..... 284
15.5.3.7	Current Consumption..... 284
15.5.3.8	Isolation and Safety..... 284
15.5.4	Model MU-GAIH22/MU-GAIH92 FTA..... 285
15.5.4.1	Description..... 285
15.5.4.2	Connectors..... 285
15.5.4.3	Field Wiring Input Signals..... 286
15.5.4.4	Auxiliary Connector Output..... 286
15.5.4.5	Indicators..... 286
15.5.4.6	Current Consumption..... 287
15.5.4.7	Isolation and Safety..... 287

Table of Contents

15.6	24 Vdc Digital Input FTAs.....	288
15.6.1	Model MU-GDID12/MU-GDID82 FTA.....	288
15.6.1.1	Description.....	288
15.6.1.2	Connectors.....	288
15.6.1.3	Field Wiring Input Signals.....	289
15.6.1.4	Line-Fault Detection.....	289
15.6.1.5	Auxiliary Connector Output.....	289
15.6.1.6	Indicators.....	290
15.6.1.7	Current Consumption.....	290
15.6.1.8	Isolation and Safety.....	290
15.6.2	Model MU-GDID13/MU-GDID83 FTA.....	291
15.6.2.1	Description.....	291
15.6.2.2	Connectors.....	291
15.6.2.3	Field Wiring Input Signals.....	291
15.6.2.4	Indicators.....	292
15.6.2.5	Current Consumption.....	292
15.6.2.6	Isolation and Safety.....	292
15.7	Analog Output FTAs.....	293
15.7.1	Model MU-GAOX02/72 and MU-GAOX12/82 FTAs.....	293
15.7.1.1	Description.....	293
15.7.1.2	Connectors.....	293
15.7.1.3	Field Wiring Output Signals.....	293
15.7.1.4	Line-Fault Detection.....	294
15.7.1.5	Calibration.....	294
15.7.1.6	Indicators.....	294
15.7.1.7	Current Consumption.....	294
15.7.1.8	Isolation and Safety.....	295
15.8	24 Vdc Digital Output FTAs.....	296
15.8.1	Model MU-GDOD12/MU-GDOD82 FTA.....	296
15.8.1.1	Description.....	296
15.8.1.2	Signal Connectors.....	296
15.8.1.3	Field Wiring Output Signals.....	296
15.8.1.4	Auxiliary Connector.....	297
15.8.1.5	Indicators.....	297
15.8.1.6	Standby Manual Device Connector.....	297
15.8.1.7	Current Consumption.....	298
15.8.1.8	Isolation and Safety.....	298
15.8.2	Model MU-GDOL12/MU-GDOL82 FTA.....	299
15.8.2.1	Description.....	299
15.8.2.2	Signal Connectors.....	299
15.8.2.3	Field Wiring Output Signals.....	299
15.8.2.4	Auxiliary Connector.....	300
15.8.2.5	Indicators.....	300
15.8.2.6	Standby Manual Device Connector.....	301
15.8.2.7	Current Consumption.....	301
15.8.2.8	Isolation and Safety.....	301
15.9	Combiner Panel.....	302
15.10	Marshalling Panel.....	303
15.10.1	Description.....	303
15.10.2	Configurations.....	304
15.10.2.1	High Level Analog Input FTAs.....	304
15.10.2.2	Digital Input FTAs.....	305
15.10.2.3	Digital Output FTAs.....	306

Figures

Figure 2-1	Nonredundant HPMM Cabinet Layout.....	4
Figure 2-2	Left 7-Slot HPMM Card File.....	7
Figure 2-3	Right 7-Slot HPMM Card File.....	9
Figure 2-4	15-Slot HPMM Card File.....	11
Figure 2-5	Left 7-Slot IOP Card File.....	13
Figure 2-6	Right 7-Slot IOP Card File.....	14
Figure 2-7	15-Slot IOP Card File.....	15
Figure 2-8	HAI FTA with Redundant HAI IOPs.....	17
Figure 2-9	Analog Output FTA with Redundant Analog Output IOPs.....	18
Figure 2-10	Standard I/O Link Extender Interconnections with Nonredundant HPMM.....	20
Figure 2-11	Standard I/O Link Extender Interconnections with Redundant HPMMs.....	21
Figure 2-12	Long Distance I/O Link Extender Interconnections with Nonredundant HPMM.....	22
Figure 2-13	Long Distance I/O Link Extender Interconnections with Redundant HPMMs.....	23
Figure 2-14	Field Termination Assembly (FTA) Sizes.....	28
Figure 2-15	Typical Vertical FTA Mounting Channel Layout.....	30
Figure 2-16	Typical FTA Compression Terminal Connector.....	31
Figure 2-17	Typical FTA Fixed-Screw Terminal Connector.....	32
Figure 2-18	Typical FTA Removable-Screw Terminal Connector.....	32
Figure 2-19	Crimp-Pin Galvanic Isolation Module Terminal Connector.....	33
Figure 2-20	Compression-Type Galvanic Isolation Module.....	34
Figure 2-21	FTA Marshalling Panel Assembly Layout.....	35
Figure 2-22	Standard Power System—Model MU-PSRX03.....	37
Figure 2-23	Standard Power System—Model MU-PSRX04.....	38
Figure 2-24	AC Only Power System—Not for CE Compliant Applications.....	40
Figure 2-25	Single Cabinet with Redundant HPMMs.....	42
Figure 2-26	Complexed Cabinets with Redundant HPMMs.....	43
Figure 2-27	Local Complexed Cabinets with Redundant HPMMs.....	44
Figure 3-1	Subsystem AC Power and Ground Connections— Multi-Ground System.....	49
Figure 3-2	Subsystem AC Power and Ground Connections— Single-Ground System.....	50
Figure 4-1	Field Termination Assembly (FTA) Sizes.....	73
Figure 4-2	Field Termination Assembly (FTA) Mounting Dimensions.....	74
Figure 6-1	Conformal Coating Symbol.....	105
Figure 7-1	I/O Link Extender Adapter Kit.....	129
Figure 7-2	Two-Port UCN Cable Tap.....	137
Figure 7-3	Four-Port UCN Cable Tap.....	138
Figure 7-4	Eight-Port UCN Cable Tap.....	138
Figure 8-1	Single-Access Cabinet.....	142
Figure 8-2	Dual-Access Cabinet.....	143
Figure 8-3	Single-Access Cabinet Bottom Cable Entry Slots.....	144
Figure 8-4	Dual-Access Cabinet Bottom Cable Entry Slots.....	145
Figure 8-5	Cabinet Interior Dimensions.....	147
Figure 8-6	Typical Single-Access Cabinet Assembly Layout.....	148
Figure 8-7	Typical Dual-Access Cabinet Assembly Layout.....	149
Figure 8-8	7-Slot Card File Installation Dimensions.....	150
Figure 8-9	15-Slot Card File Installation Dimensions.....	151
Figure 8-10	Installation of 7-Slot and 15-Slot Card Files.....	152
Figure 8-11	Power System Installation Dimensions.....	153
Figure 8-12	Typical Vertical FTA Mounting Channel Configurations.....	156
Figure 8-13	Vertical FTA Mounting Channel Dimensions.....	157
Figure 8-14	Vertical FTA Mounting Channel Installation Holes.....	158
Figure 8-15	Horizontal FTA Mounting Channel Cabinet Layout.....	160
Figure 8-16	Horizontal FTA Mounting Channel Dimensions.....	161

Figures

Figure 8-17	Horizontal FTA Mounting Channel Installation Holes.....	162
Figure 8-18	Cabinet Floor Planning Template	163
Figure 9-1	Single-Access Cabinet.....	166
Figure 9-2	Dual-Access Cabinet.....	167
Figure 9-3	Cabinet Base Panel Grounding Procedure	168
Figure 9-4	Cabinet Panel and Door Grounding Procedure	168
Figure 9-5	Single-Access Cabinet Bottom Cable Entry	169
Figure 9-6	Dual-Access Cabinet Bottom Cable Entry	170
Figure 9-7	Cabinet Interior Dimensions.....	172
Figure 9-8	Typical Single-Access Cabinet Assembly Layout.....	173
Figure 9-9	Typical Dual-Access Cabinet Assembly Layout.....	174
Figure 9-10	7-Slot Card File Installation Dimensions.....	175
Figure 9-11	15-Slot Card File Installation Dimensions.....	176
Figure 9-12	Installation of 7-Slot and 15-Slot Card Files.....	177
Figure 9-13	Power System Installation Dimensions.....	178
Figure 9-14	FTA Mounting Channel Configurations.....	181
Figure 9-15	FTA Mounting Channel Dimensions.....	182
Figure 9-16	FTA Mounting Channel Mounting FTA Installation Holes.....	183
Figure 9-17	Horizontal FTA Mounting Channel Cabinet Layout	185
Figure 9-18	Horizontal FTA Mounting Channel Dimensions	186
Figure 9-19	Horizontal FTA Mounting Channel Installation Holes.....	187
Figure 9-20	Cabinet Floor Planning Template	188
Figure 10-1	Single Cabinet with Redundant HPMMs	191
Figure 10-2	Dual Cabinets with Redundant HPMMs.....	192
Figure 10-3	Redundant HPMM Configuration Cabling	193
Figure 10-4	Local/Remote Cabinet Configuration.....	196
Figure 11-1	Standard I/O Link Extender Interconnections with Single HPMM.....	199
Figure 11-2	Standard I/O Link Extender Interconnections with Redundant HPMMs.....	200
Figure 11-3	Long Distance I/O Link Extender Interconnections with Single HPMM.....	201
Figure 11-4	Long Distance I/O Link Extender Interconnections with Redundant HPMMs.....	202
Figure 11-5	Remote Site Multi-IOP Card File I/O Link Interface Cabling.....	203
Figure 11-6	ST-Type Connector	209
Figure 12-1	LLMux Configuration Interconnections – CE Compliant.....	218
Figure 12-2	Remote CJR Installation.....	222
Figure 12-3	Nonincendive RHMUX Configuration Interconnections.....	226
Figure 12-4	Intrinsically Safe RHMUX Configuration Interconnections.....	227
Figure 13-1	Serial Device Interface Interconnections.....	234
Figure 14-1	Serial Interface FTA to Modbus Device EIA-232 and EIA-422/485 Interconnections.....	243
Figure 14-2	Serial Interface FTA to Modbus Device EIA-422/485 Interconnections.....	244
Figure 14-3	Serial Interface FTA to Peripheral Device EIA-422/485 Interconnections.....	245
Figure 14-4	Serial Interface FTA to Allen-Bradley Device EIA-232 Interconnections.....	246
Figure 15-1	Typical Galvanically Isolated FTA.....	259
Figure 15-2	Galvanic Isolation Module.....	260
Figure 15-3	Crimp-Type Galvanic Isolation Module Terminal Connector.....	261
Figure 15-4	Compression-Type Galvanic Isolation Module Terminal Connector	262
Figure 15-5	Galvanically Isolated FTA with Auxiliary Connector	266
Figure 15-6	Cabinet with Horizontally Installed FTA Mounting Channels.....	270

Tables

Table 2-1	Card File Models	5
Table 2-2	Standard Field Termination Assembly Types.....	25
Table 2-3	Galvanically Isolated Field Termination Assembly Types.....	27
Table 3-1	HPM Assembly 24 Vdc Power Usage	54
Table 3-2	Single Power System Calculation Example	58
Table 3-3	Dual Power System Calculation Example (Power System 1)	59
Table 3-4	Dual Power System Calculation Example (Power System 2)	60
Table 4-1	Standard FTAs and Associated Assemblies.....	75
Table 4-2	Galvanically Isolated FTAs and Associated Assemblies	78
Table 5-1	Hazardous Area Classifications.....	84
Table 5-2	HPM Equipment Approved for Use in a Division 2 Area	87
Table 5-3	Nonincendive FTA Types	101
Table 5-4	FTA Cable and Load Parameters.....	102
Table 6-1	Environment Minimum Equipment Requirement.....	103
Table 6-2	Harsh Environment Definitions from ANSI/ISA-S71.04-1985	104
Table 6-3	Conformally Coated Assembly Model Numbers.....	107
Table 7-1	Card Files	116
Table 7-2	IOPs—Nonconformally Coated	118
Table 7-3	IOPs—Conformally Coated.....	119
Table 7-4	Field Termination Assemblies—Nonconformally Coated.....	120
Table 7-5	Field Termination Assemblies—Conformally Coated.....	125
Table 7-6	IOP to FTA Cables.....	130
Table 7-7	Non-CE Compliant Subsystem Power Cables	133
Table 7-8	CE Compliant Subsystem Power Cables.....	134
Table 7-9	Power Cables without I/O Link Protector Module.....	135
Table 7-10	I/O Link Interface Cable Sets	136
Table 11-1	Minimum Bend Radius for Indoor Cable	207
Table 11-2	Standard Optical Power Loss.....	211
Table 11-3	Standard Fiber Optic Cable Losses (@ 850 nm)	211
Table 11-4	Long Distance Optical Power Loss.....	213
Table 11-5	Long distance Fiber Optic Cable Losses (@ 1300 nm).....	213
Table 12-1	LLMux Assemblies	216
Table 12-2	RHMUX Assemblies	223
Table 14-1	Serial Interface FTAs	241
Table 14-2	Serial Interface EIA-232 Specifications	252
Table 14-3	Serial Interface EIA-422/485 Specifications	252
Table 15-1	CE Compliant Galvanically Isolated FTAs—Nonconformally Coated ...	256
Table 15-2	CE Compliant Galvanically Isolated FTAs—Conformally Coated	257
Table 15-3	Galvanically Isolated FTA Power Requirements	267

Acronyms

AC	Alternating Current
ANSI	American National Standards Institute
AO	Analog Output
AWG	American Wire Gauge
CJR	Cold Junction Reference
CMOS	Complementary Metal Oxide Semiconductor
DC	Direct Current
DISOE	Digital Input Sequence of Events
DI	Digital Input
DO	Digital Output
EIA	Electronic Industries Association
EMI	Electromagnetic Interference
FM	Factory Mutual Research, Inc.
FTA	Field Termination Assembly
GI	Galvanic Isolation
HLAI	High Level Analog Input
HPM	High-Performance Process Manager
HPMM	High-Performance Process Manager Module
IS	Intrinsic Safety
I/O	Input/Output
IEC	International Electrotechnical Commission
IEEE	Institute of Electrical and Electronic Engineering
ISA	Instrument Society of America
ISO	International Standards Organization
LCN	Local Control Network
LFD	Line Fault Detection
LLAI	Low Level Analog Input
LLMux	Low Level Analog Input Multiplexer
MRG	Master Reference Ground
NE	National Electrical Code
NEMA	National Electrical Manufacturer's Association
NFPA	National Fire Protection Agency
NiCad	Nickel Cadmium
NIM	Network Interface Module
PI	Pulse Input
PSM	Power Supply Module
PS	Power System
PVC	Polyvinyl Chlorine
PV	Process Variable
RHMUX	Remote Hardened Low Level Analog Input Multiplexer
RTD	Resistive Temperature Device
RTU	Remote Terminal Unit
SDI	Serial Device Interface
SI	Serial Interface
STI	Smart Transmitter Interface
STIM	Smart Transmitter Interface Multivariable
TC	Thermocouple
UCN	Universal Control Network
UV	Ultra Violet

References

Publication Title	Publication Number	Binder Title	Binder Number
<i>High-Performance Process Manager Specification and Technical Data</i>	HP03-500	System Summary - 2	TPS 3010-2
<i>High-Performance Process Manager Installation</i>	HP20-500	Implementation/ High-Performance Process Manager - 3	TPS 3066-3
<i>High-Performance Process Manager Checkout</i>	HP20-510	Implementation/ High-Performance Process Manager - 3	TPS 3066-3
<i>High-Performance Process Manager Service</i>	HP13-500	PM/APM/HPM Service - 1	TPS 3061-1
<i>Process Manager I/O Specification and Technical Data</i>	IO03-500	System Summary - 2	TPS 3010-2
<i>Process Manager I/O Installation</i>	PM20-520	Implementation/ High-Performance Process Manager - 3	TPS 3066-3
<i>TPS System Site Planning</i>	SW02-550	System Site Planning - 1	TPS 3020-1
<i>Universal Control Network Specification and Technical Data</i>	UN03-500	System Summary - 2	TPS 3010-2
<i>Universal Control Network Planning</i>	UN02-501	System Site Planning - 1	TPS 3020-1
<i>Universal Control Network Installation</i>	UN20-500	Installation/Universal Control Network	TPS 3041
<i>Universal Control Network Guidelines</i>	UN12-510	Installation/Universal Control Network	TPS 3041
<i>Local Control Network Planning</i>	SW02-501	System Site Planning - 1	TPS 3020-1
<i>LCN System Installation</i>	SW20-500	LCN Installation	TPS 3025
<i>LCN System Checkout</i>	SW20-510	LCN Installation	TPS 3025
<i>LCN Guidelines - Implementation, Troubleshooting, and Service</i>	LC09-510	LCN Installation	TPS 3025

Section 1 – Introduction

1.1 Overview

Section contents The topics covered in this section are:

	Topic	See Page
1.1	Overview.....	1

The manual's purpose This manual is intended for planning the installation of a High-Performance Process Manager (HPM) subsystem at a TPS system site. The High-Performance Process Manager subsystem is a device on the Universal Control Network (UCN) that includes the Network Interface Module (NIM). Process Managers (PMs), Advanced Process Managers (APMs), and Logic Managers (LMs) may also be resident on the network.

The manual's contents Planning includes the consideration of the High-Performance Process Manager cabinet layout, process wiring techniques, Division 2 environment equipment approval, conformal coating of the assemblies to protect against a corrosive environment, HPMM and IOP redundancy, and unique hardware features, such as fiber optic I/O Link Extenders, Low Level Analog Input Multiplexer FTAs, Serial Device Interface FTAs, Serial Interface FTAs, and Galvanically Isolated FTAs.

Information not covered Neither installation, power on checkout, or service of the High-Performance Process Manager, nor planning for the Local Control Network (LCN) is addressed in this manual. See the related reference documentation for information about these topics.

Section 2 – HPM Description

2.1 Overview

Section contents The topics covered in this section are:

	Topic	See Page
2.1	Overview.....	3
2.2	Card Files.....	5
2.2.1	HPMM Card Files	6
2.2.2	Input/Output Processor (IOP) Card Files.....	13
2.3	Input/Output Processor (IOP) Cards.....	17
2.3.1	IOP Redundancy	18
2.4	I/O Link Extender (Fiber Optic Link).....	20
2.5	Field Termination Assemblies (FTAs)	25
2.6	Power Systems	36
2.7	Cabinet Configurations	41

HPM major assemblies The High-Performance Process Manager subsystem (HPM) consists of major assemblies described in the following subsections. The major High-Performance Process Manager assemblies are

- High-Performance Process Manager Module (HPMM) card file
- Input/Output Processor (IOP) card file
- Input/Output Processor (IOP) card
- I/O Link Extender
- Field Termination Assembly (FTA)
- Power System

Continued on next page

2.1 Overview, Continued

Nonredundant HPM cabinet layout

Figure 2-1 is an illustration of a single High-Performance Process Manager cabinet containing a nonredundant High-Performance Process Manager Module (HPMM) with supporting assemblies. The HPMM cards (2) and the IOPs cards are installed in 15-Slot HPMM card files. IOP cards occupy the IOP card files.

Figure 2-1 Nonredundant HPMM Cabinet Layout

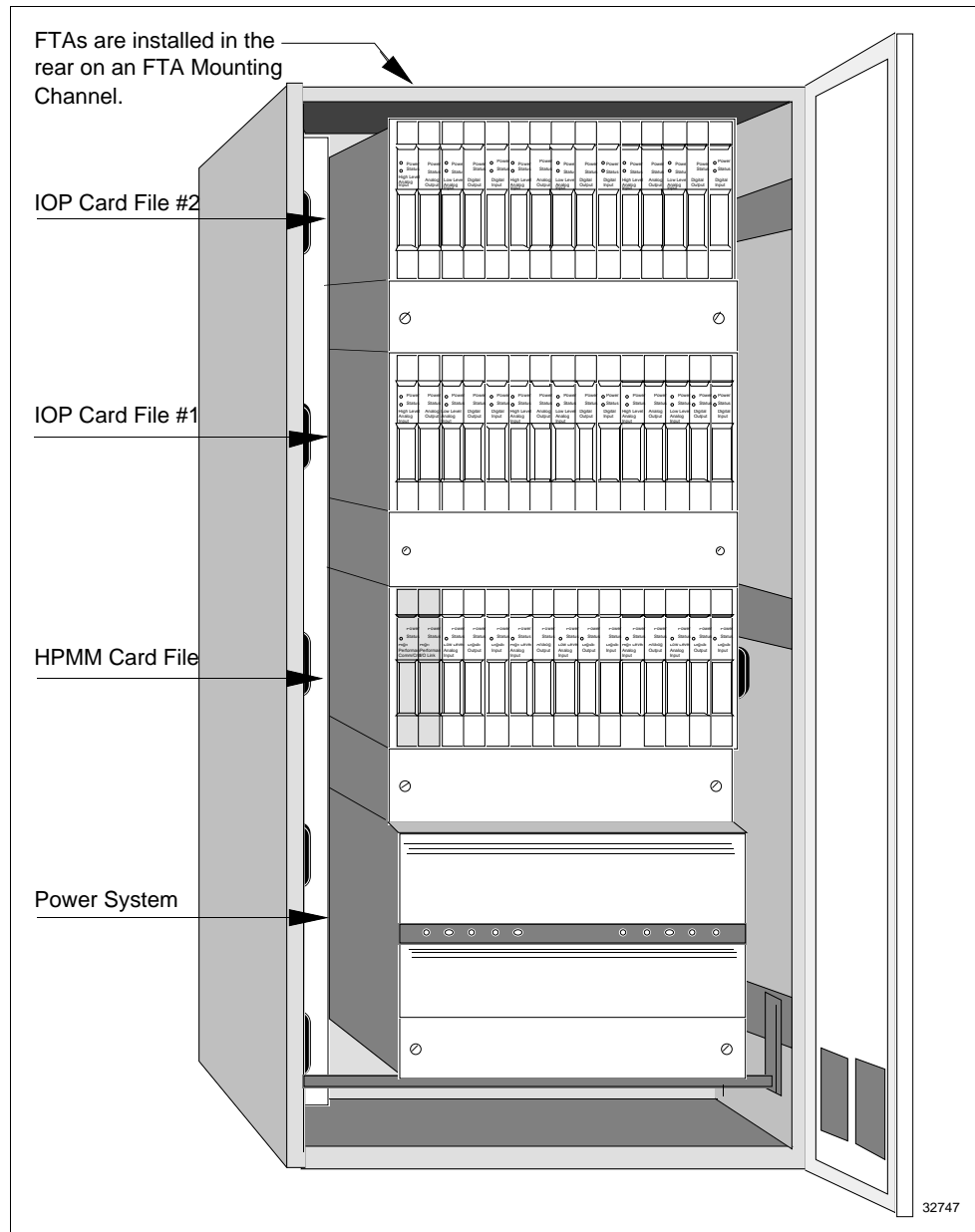

2.2 Card Files

Introduction

There are nine card file models. Three models are not CE Compliant and six models are CE Compliant. Table 2-1 lists the nine card file models. All models are also available with conformal coating (a model number with a prefix of MC, rather than MU).

Table 2-1 Card File Models

Card File Description	CE Compliant	Non-CE Compliant
Left 7-Slot HPMM or IOP	N/A	MU-HPFH01
Right 7-Slot HPMM or IOP	N/A	MU-HPFH11
15-Slot HPMM or IOP	N/A	MU-HPFX02
Left 7-Slot HPMM	MU-HPFH03	N/A
Right 7-Slot HPMM	MU-HPFH13	N/A
15-Slot HPMM	MU-HPFX03	N/A
Left 7-Slot IOP	MU-HPFI03	N/A
Right 7-Slot IOP	MU-HPFI13	N/A
15-Slot IOP	MU-HPFI23	N/A

Non-CE Compliant card file models

The non-CE Compliant card file models can be designated as an HPMM card file or an IOP card file by either installing an HPMM card set in the two left-most card slots or installing IOP cards.

CE Compliant card file models

Unlike the non-CE Compliant card file models, the CE Compliant card file models are designated either an HPMM card file or an IOP card file because even though their is no electrical difference in the backpanel, they differ mechanically. The addition of a ground plate and filtered IOP connectors in the two left-most slots prohibits the installation of an HPMM card set.

The card file is designated an IOP card file when the ground plate and filtered connectors are present.

The card file is designated an HPMM card file when the ground plate and filtered connectors are absent.

Conversion kit

A CE Compliant HPMM card file can be converted to an IOP card file with a model MU-ZPFI03 upgrade kit. The kit adds 2 filtered IOP adapter connectors to the two left-most card slots and a ground plate extension.

2.2.1 HPMM Card Files

Three types of HPMM card files

There are three types of HPMM card files. The two left-most slots of each type are populated by the three assemblies that comprise the HPMM. The remaining slots accommodate IOPs.

If the card file is a non-CE Compliant card file, the two left-most slots of each type can also accommodate IOPs with no alterations. The card file is then designated an IOP card file.

HPMM description

The High-Performance Process Manager Module (HPMM) is composed of two card assemblies that install in the two left-most slots in a 7-Slot or 15-Slot card file, and a UCN interface module that mounts and connects to the 50-pin connector that is directly below the left-most card.

The three HPMM assemblies are identified as follows:

- High-Performance Communications/Control (High-Performance Comm/Control) card
- High-Performance I/O Link Interface (High-Performance I/O Link) card
- High-Performance UCN Interface (HPM UCN Interface) module

The HPM UCN Interface module connects to the 50-pin connector below the High-Performance Comm/Control card.

Left 7-Slot HPMM card file description

The Left 7-Slot card file accepts the two HPMM cards and the HPM UCN Interface module that comprise the HPMM, and accommodates up to five IOP cards. The card slots are numbered 1 through 7, starting at the left-most position.

The High-Performance Comm/Control and High-Performance I/O Link cards occupy slots 1 and 2, while the HPM UCN Interface module mounts below slot 1 and connects to its 50-pin connector.

Slots 3 through 7 can accommodate IOP cards. The IOP card slots assume numerical I/O Link Interface addresses of 3 through 7 and binary I/O Link Interface addresses of 2 through 6.

Continued on next page

2.2.1 HPMM Card Files, Continued

Left 7-Slot HPMM card file illustration

Figure 2-2 is an illustration of a Left 7-Slot HPMM card file and the two HPMM cards that occupy slots 1 and 2.

Figure 2-2 Left 7-Slot HPMM Card File

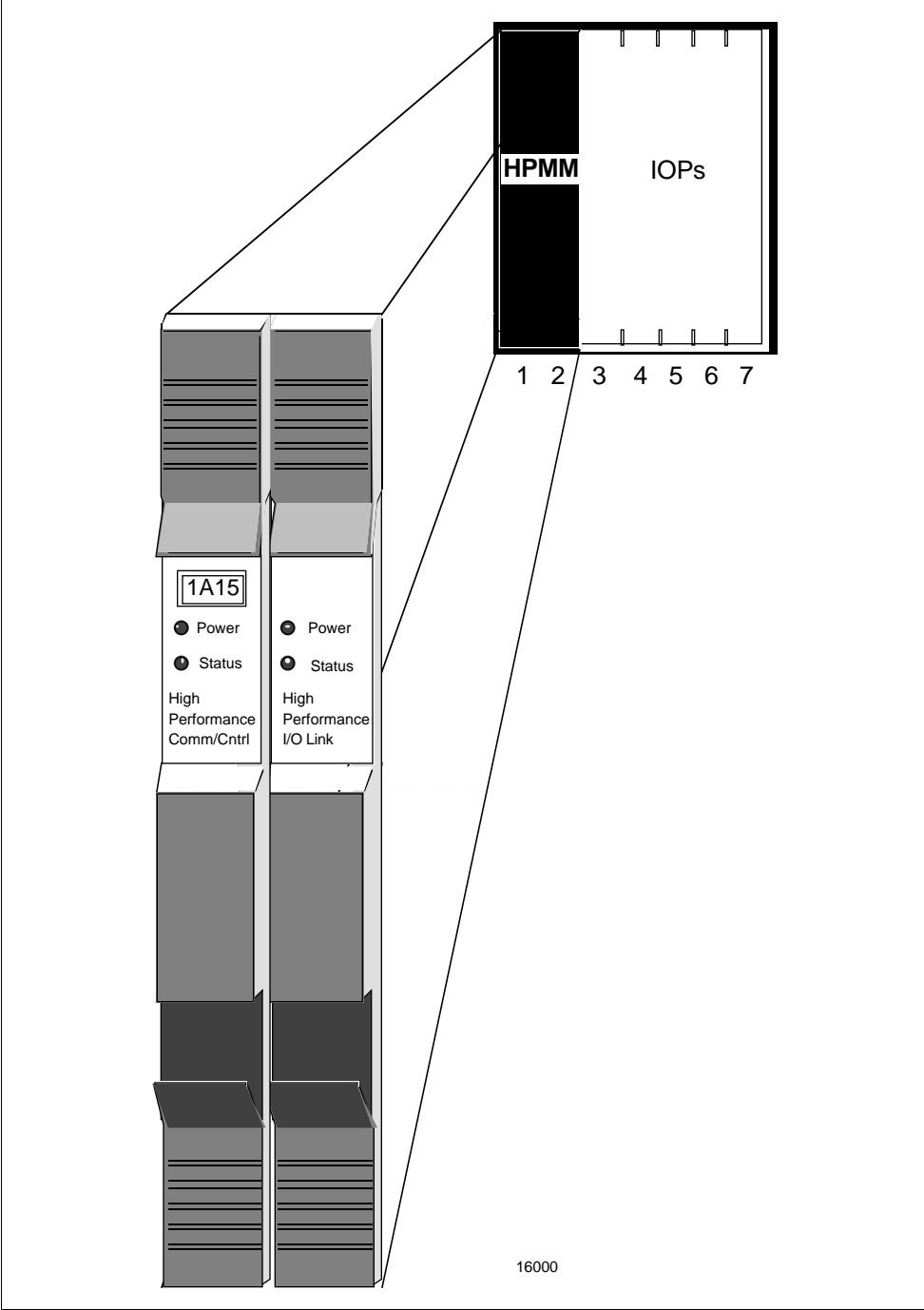

Continued on next page

2.2.1 HPMM Card Files, Continued

Right 7-Slot HPMM card file description

The description of the Right 7-Slot HPMM card file is identical to the Left 7-Slot HPMM card file, except the two HPMM cards and the UCN interface module occupy slots 9 and 10. The card slots are numbered 9 through 15.

Slots 11 through 15 accommodate IOP cards. The IOP card slots assume numerical I/O Link Interface addresses of 11 through 15 and binary I/O Link Interface addresses of 10 through 14.

Continued on next page

2.2.1 HPMM Card Files, Continued

Right 7-Slot HPMM card file illustration

Figure 2-3 is an illustration of a Right 7-Slot HPMM card file and the two HPMM cards that occupy slots 9 and 10.

Figure 2-3 Right 7-Slot HPMM Card File

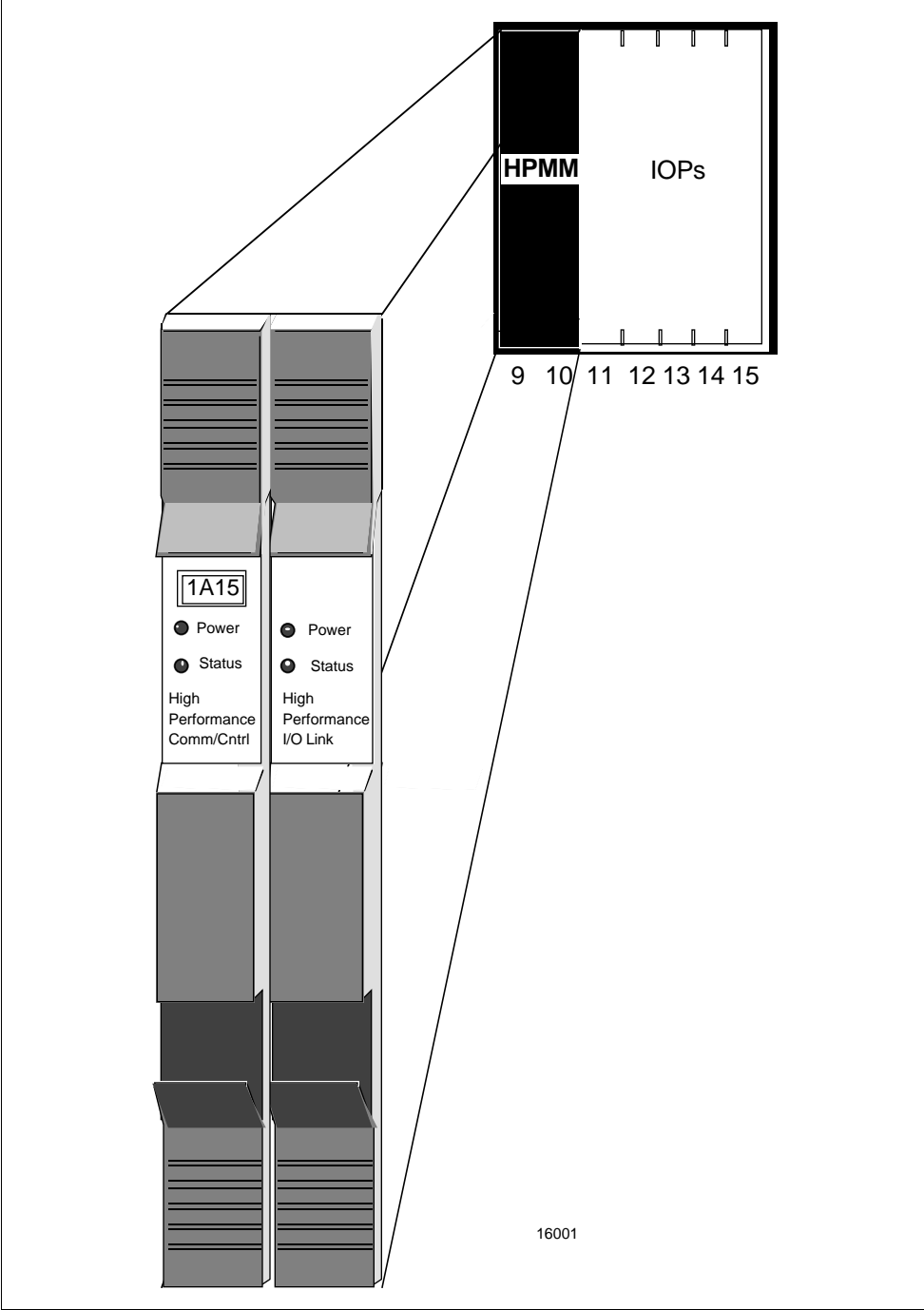

Continued on next page

2.2.1 HPMM Card Files, Continued

15-Slot HPMM card file description

The 15-Slot card file accepts the two HPMM cards and the UCN interface module that comprise the HPMM, and accommodates up to thirteen IOP cards. The card slots are numbered 1 through 15, starting at the left-most position.

The High-Performance Comm/Control and High-Performance I/O Link cards occupy slots 1 and 2, while the HPM UCN Interface module mounts below slot 1 in its 50-pin connector.

Slots 3 through 15 can accommodate IOP cards. The IOP card slots assume numerical I/O Link Interface addresses of 3 through 15 and binary I/O Link Interface addresses of 2 through 14.

When populated with the HPMM cards, the card file is designated a 15-Slot HPMM card file.

Continued on next page

2.2.1 HPMM Card Files, Continued

15-Slot HPMM card file illustration

Figure 2-4 is an illustration of a 15-Slot HPMM card file and the two HPMM cards that occupy slots 1 and 2.

Figure 2-4 15-Slot HPMM Card File

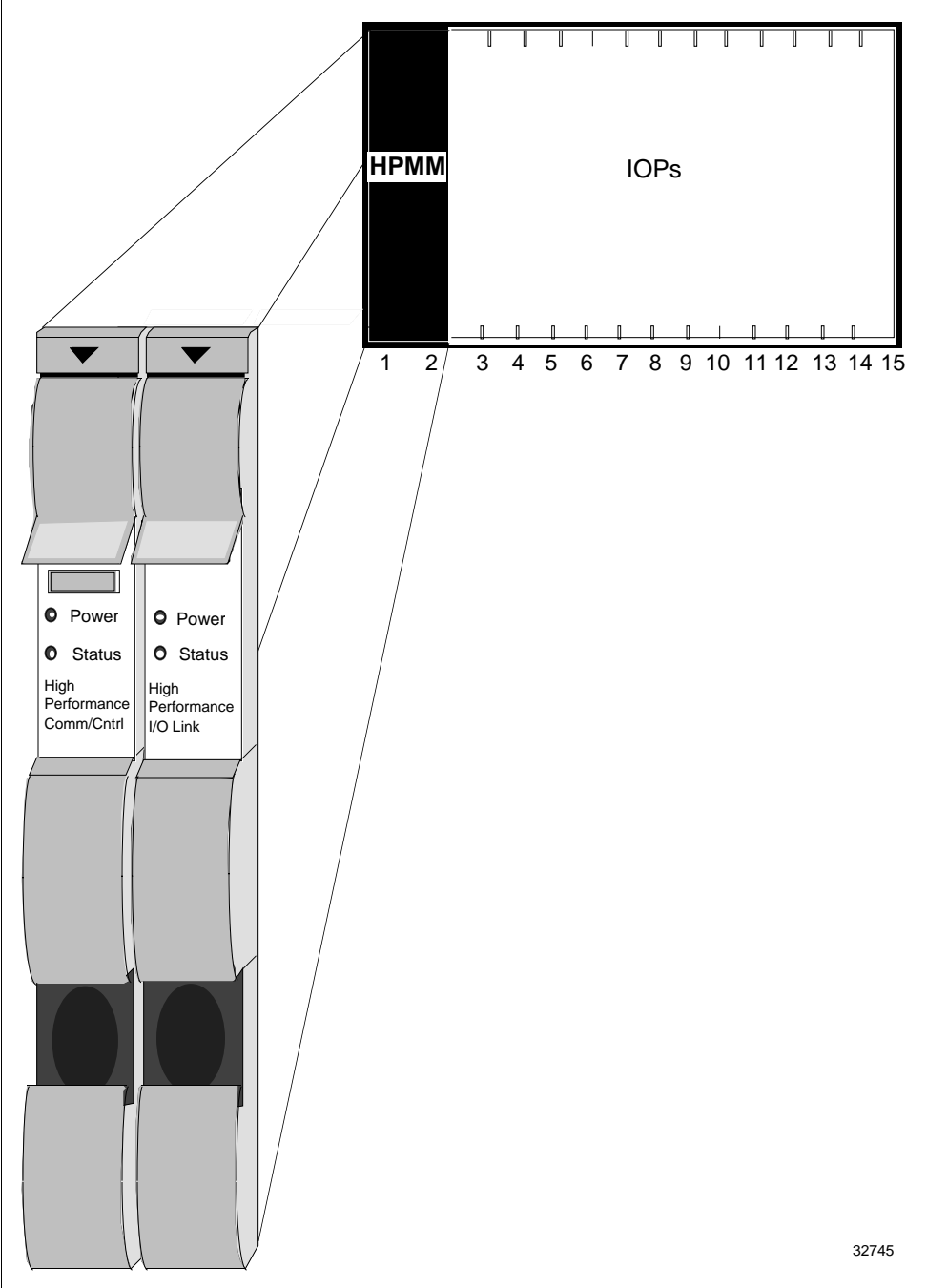

Continued on next page

2.2.1 HPMM Card Files, Continued

7-Slot HPMM card file usage	<p>The two types of 7-Slot HPMM card files are intended to be used in a small HPM subsystem.</p> <p>When the subsystem consists of nonredundant HPMMs, a Left 7-Slot HPMM card file must be installed. For a subsystem that requires redundant HPMMs, Left and Right 7-Slot HPMM card files are installed. Both card files are assigned the same the same I/O Link Interface address. There is no slot 8 because the card file slots are numbered 1 through 7 and 9 through 15.</p>
15-Slot HPMM card file usage	<p>The 15-Slot HPMM card file is intended for use in a larger HPM subsystem, either with nonredundant or redundant HPMMs. Unlike the 7-Slot HPMM card file, there is no “loss” of a card slot.</p>
HPMM functionality	<p>The HPMM provides the following functions:</p> <ul style="list-style-type: none">• Communications with the Local Control Network (LCN) Network Interface Module (NIM) through the Universal Control Network (UCN)• A Communications processor (Motorola 68LC040)• Communications through the I/O Link Interface with Input/Output Processors (IOPs) and I/O Link Extenders• A Control processor (Motorola 68040)• Separate and shared memory for the Communications and Control processors• An I/O Link processor (Intel 80C32) with SRAM• HPMM redundancy control

2.2.2 Input/Output Processor (IOP) Card Files

IOP card file descriptions	<p>The 7-Slot and 15-Slot IOP card files are electrically identical to the HPMM card files, except that an HPMM card set is not installed in the card file. IOPs can be installed in the two left-most card slots.</p>
Non-CE Compliant card files	<p>Non-CE Compliant HPMM and IOP card files differ only in the application. Electrically and mechanically, their backpanels are the same. The card file model numbers are the same.</p>
CE Compliant card files	<p>CE Compliant HPMM and IOP card files differ mechanically. IOP card files have filtered IOP connectors and connector ground plates. Electrically, their backpanels are the same. The card file model numbers are different.</p>

Continued on next page

2.2.2 Input/Output Processor (IOP) Card Files, Continued

Left 7-Slot IOP card file Figure 2-5 illustrates a Left 7-Slot IOP card file.
Figure 2-5 Left 7-Slot IOP Card File

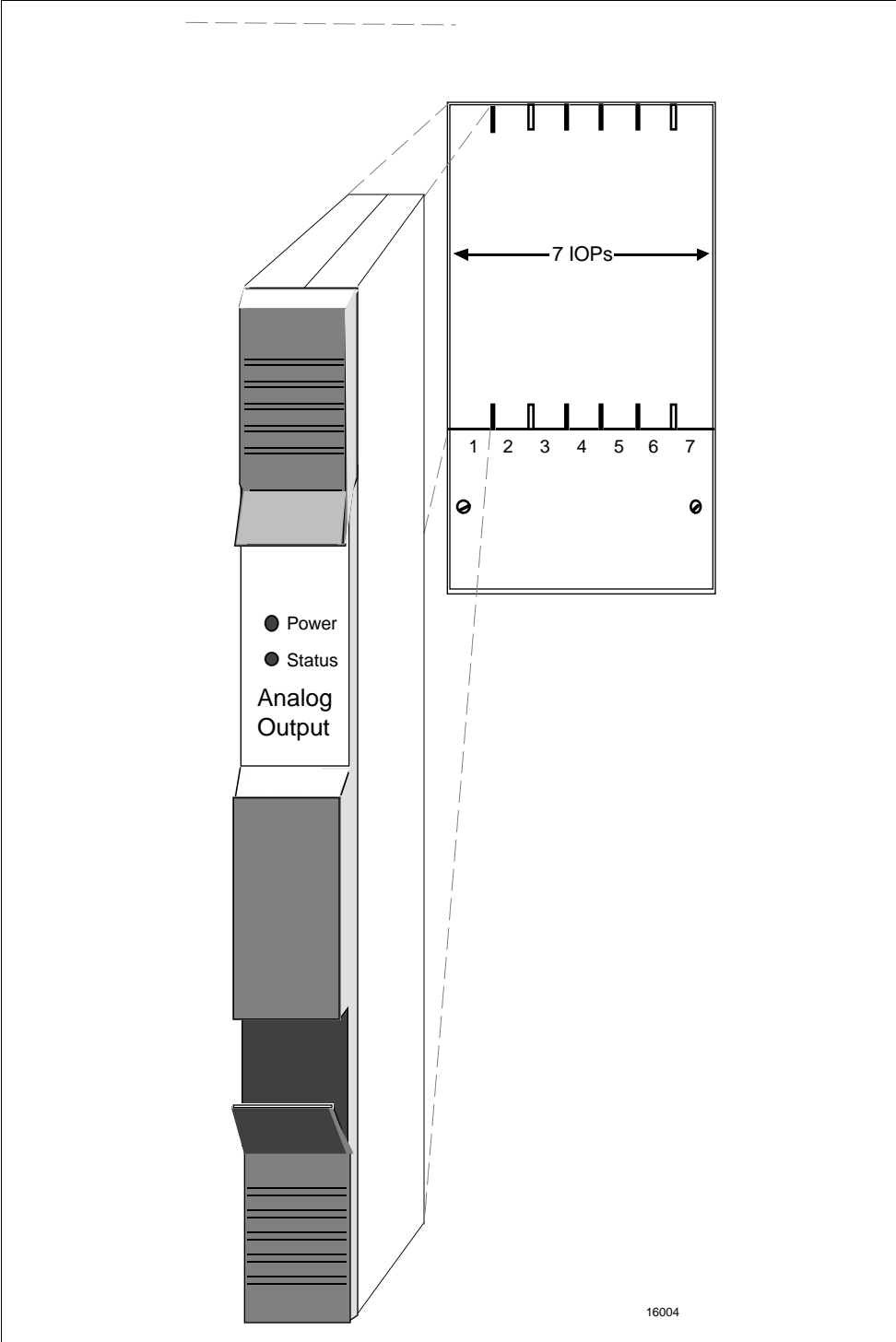

Continued on next page

2.2.2 Input/Output Processor (IOP) Card Files, Continued

Right 7-Slot IOP card file

Figure 2-6 illustrates a Left 7-Slot IOP card file.

Figure 2-6 Right 7-Slot IOP Card File

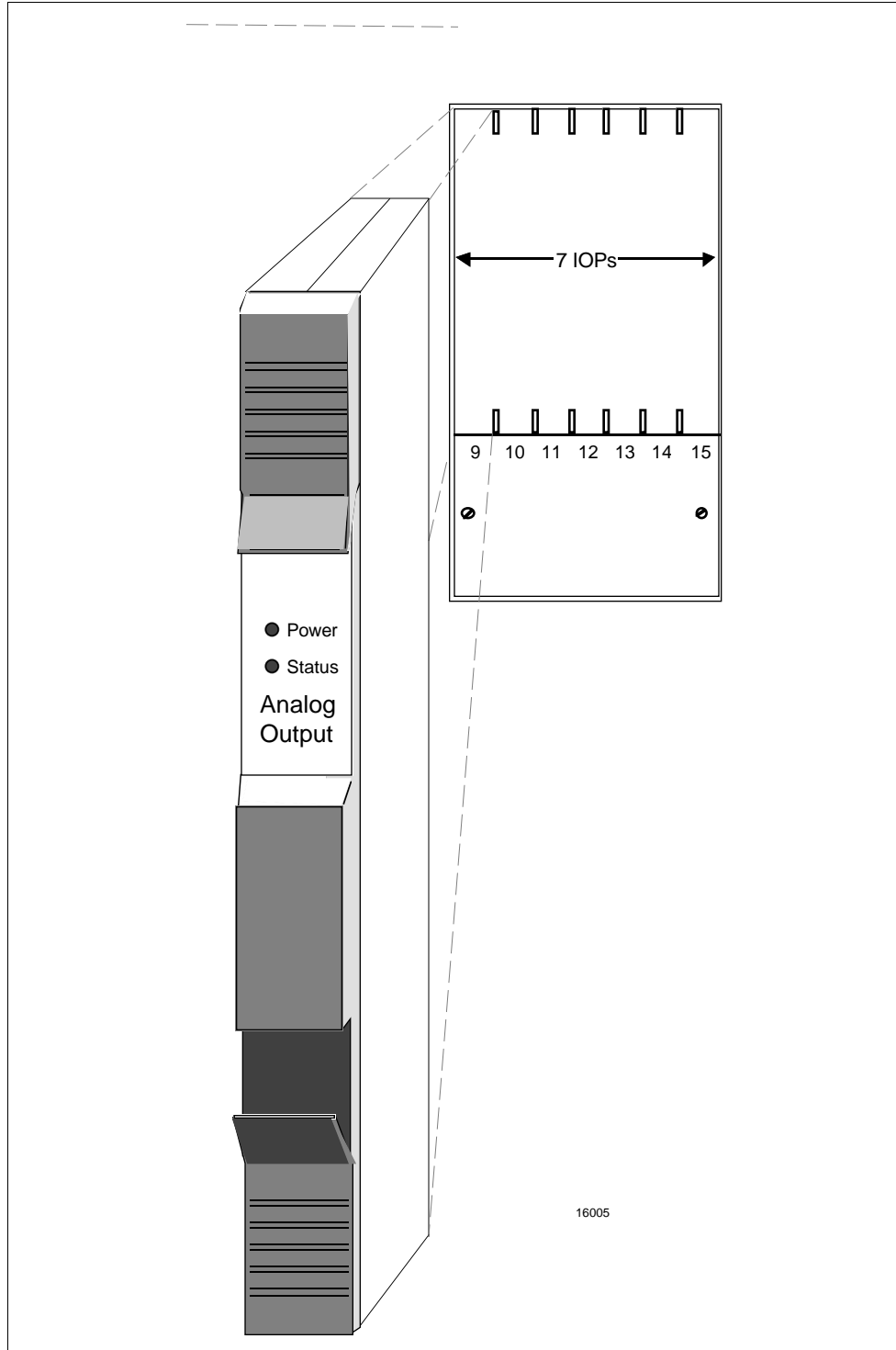

Continued on next page

2.2.2 Input/Output Processor (IOP) Card Files, Continued

15-Slot IOP card file

Figure 2-7 illustrates a 15-Slot IOP card file.
Figure 2-7 15-Slot IOP Card File

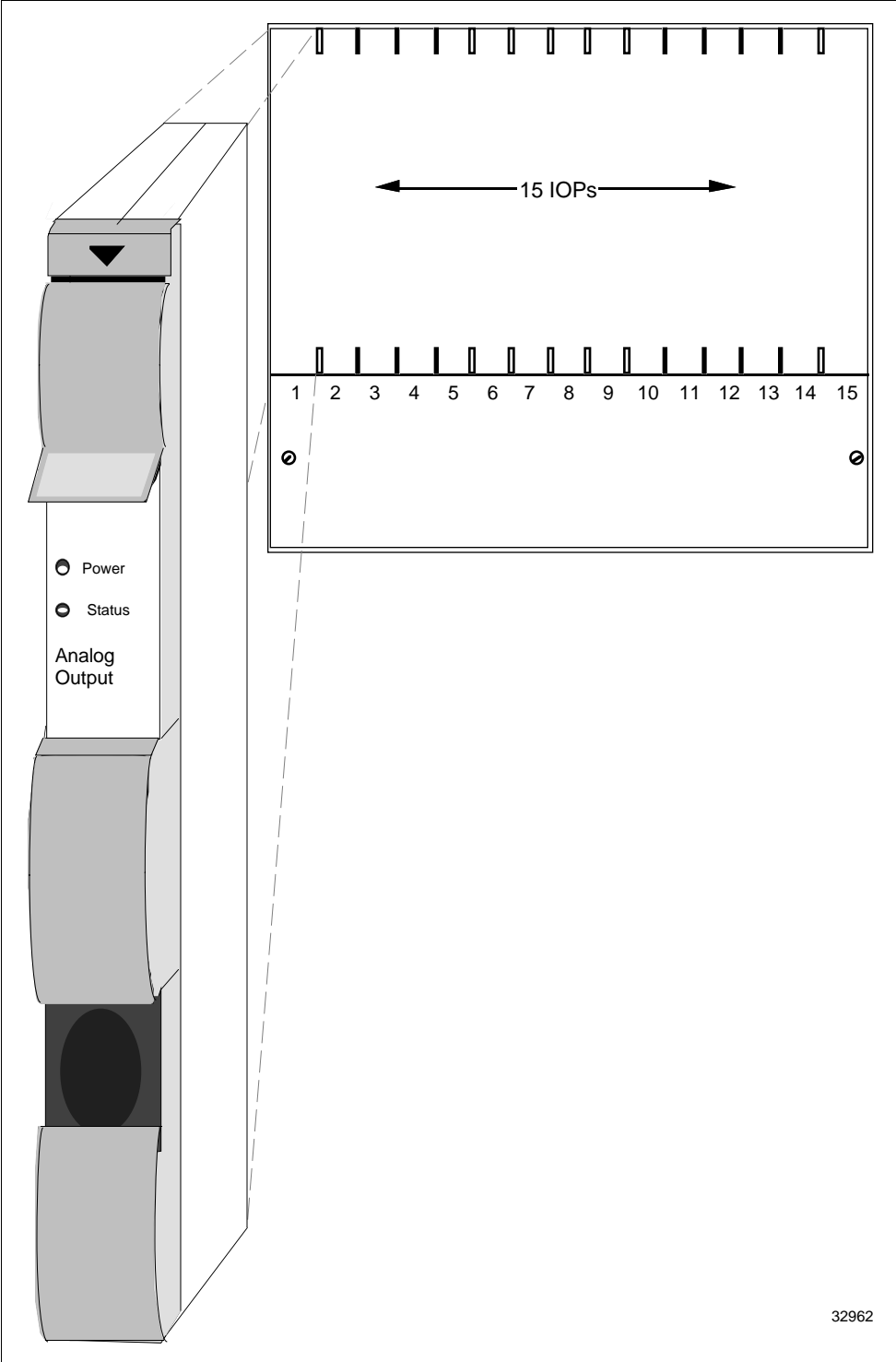

2.3 Input/Output Processor (IOP) Cards

Types of Input/Output Processors (IOPs)

There are thirteen types of Input/Output Processor (IOP) card assemblies. Some IOP card types interface with more than one type of Field Termination Assembly (FTA). The functional types of IOPs are

- High Level Analog Input (HLAI)
 - Low Level Analog Input (LLAI)
 - Low Level Analog Multiplexer (LLMux)
 - Remote Hardened Low Level Analog Multiplexer (RHMUX)
 - Digital Input (DI)
 - Analog Output (AO)
 - Digital Output (DO)
 - Smart Transmitter Interface (STI)
 - Smart Transmitter Interface Multivariable (STIM)
 - Pulse Input (PI)
 - Digital Input Sequence of Events (DISOE)
 - Serial Device Interface (SDI)
 - Serial Interface (SI)
-

Card file configurations

Additional IOP card file slots can be added to any High-Performance Process Manager subsystem. Each IOP card file accommodates up to 7 or 15 IOPs as illustrated in Figures 2-5 through 2-7. A total of eight 15-Slot card files or 7-Slot card file pairs (Left and Right), including HPMM card files, can exist in a High-Performance Process Manager subsystem. However, the limit is eight because each 15-Slot card file and pair of 7-Slot card files must be assigned an I/O Link Interface address between 0 and 7.

IOP card files can be installed at remote locations with the use of fiber optic I/O Link Extenders, as well as locally in the cabinet or cabinet complex containing the HPMM card file(s).

A total of 40 primary IOPs, 40 secondary (redundant) IOPs, and 3 I/O Link Extenders (a maximum of 8 I/O Link Extender cards) can exist in a single High-Performance Process Manager subsystem.

2.3.1 IOP Redundancy

IOP redundancy

The HPM subsystem supports IOP redundancy for the following types of IOPs:

- High Level Analog Input (HLAI)
- Smart Transmitter Interface (STI or STIM)
- Analog Output (AO)
- Digital Input (DI)
- Digital Input Sequence of Events (DISOE)
- Digital Output (DO)

Presently, not all Digital Input and Digital Output IOP models support redundancy.

Redundant HLAI IOPs

A pair of IOPs can be connected in a redundant configuration with both IOPs connected by separate cables to the same FTA. Figure 2-8 illustrates an HLAI FTA that interfaces with a pair of HLAI IOPs that are installed in separate card files.

Figure 2-8 HLAI FTA with Redundant HLAI IOPs

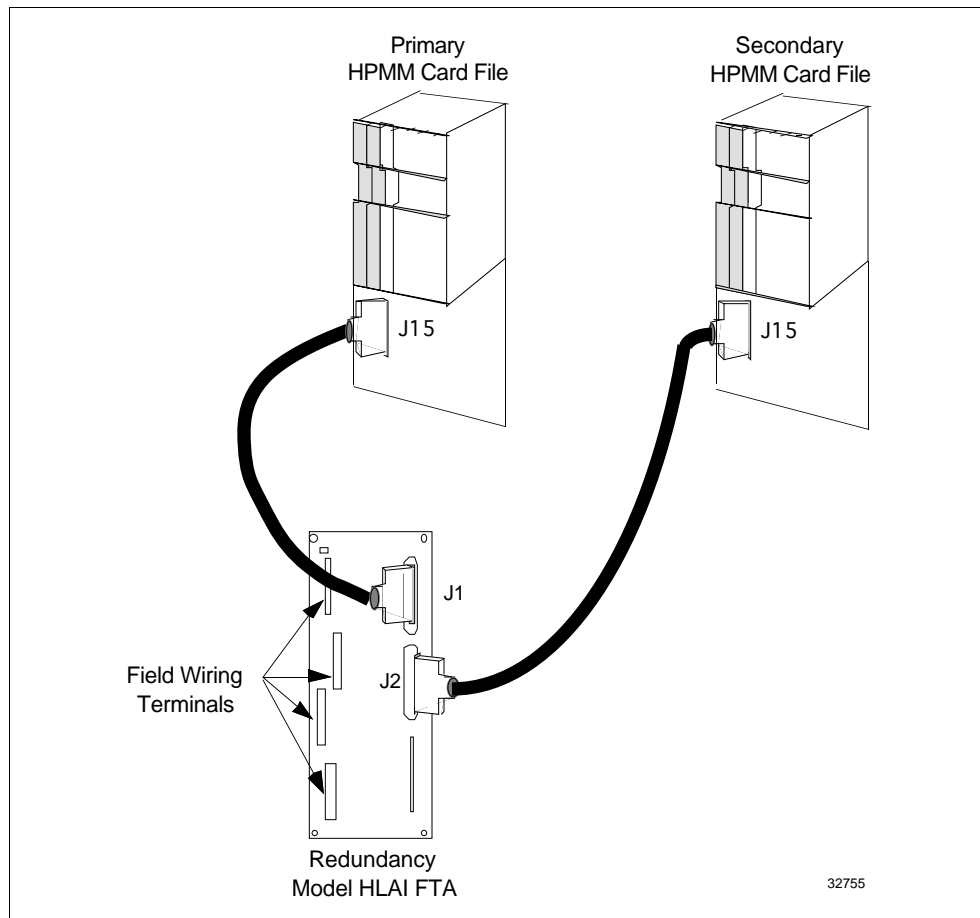

Continued on next page

2.3.1 IOP Redundancy, Continued

Redundant AO IOPs

Output type FTAs can also interface with two IOPs with separate cables, and an automatic selector switch on the FTA selects which IOP's output drives the field wiring terminal connectors on the FTA. Figure 2-9 is an illustration of an Analog Output (AO) FTA interface with two Analog Output IOPs.

Figure 2-9 Analog Output FTA with Redundant Analog Output IOPs

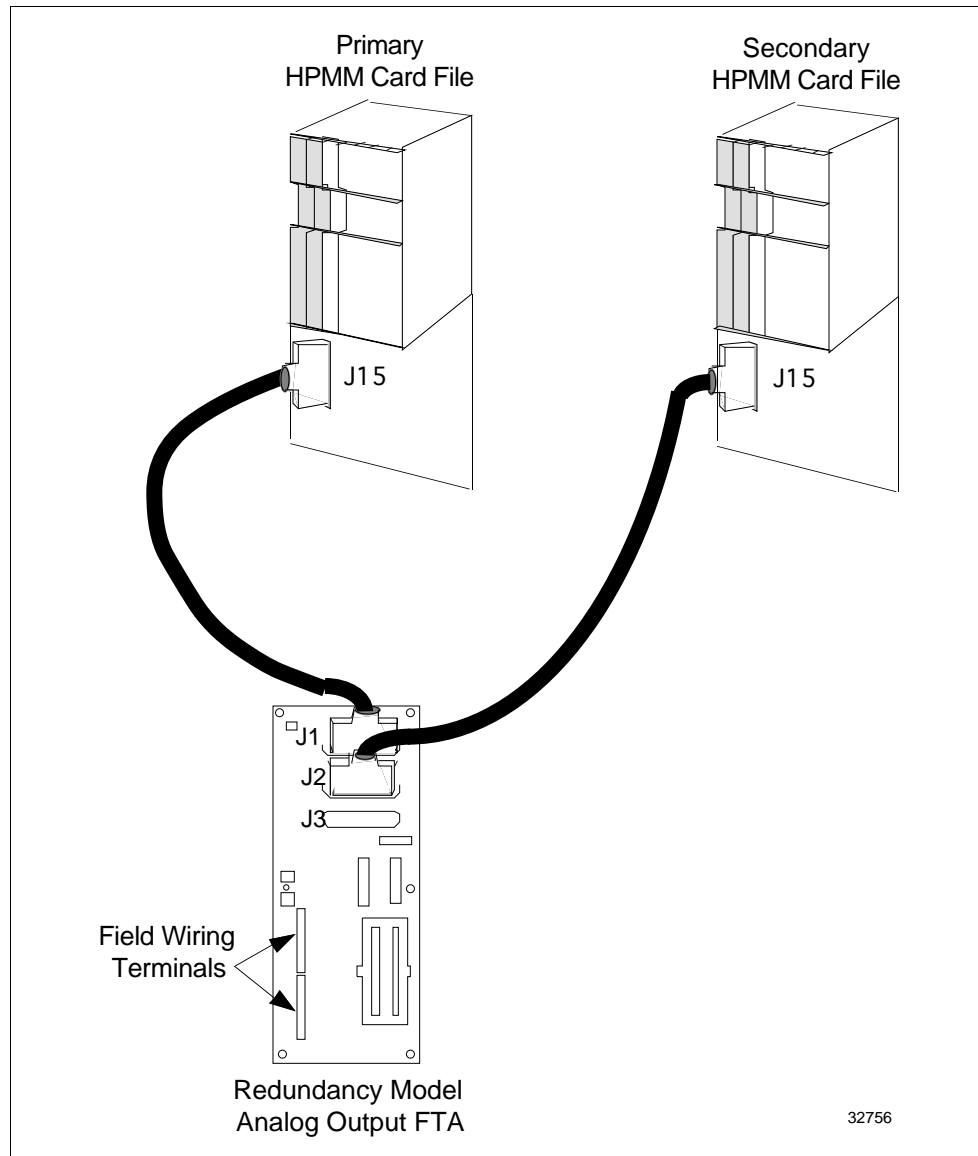

2.4 I/O Link Extender (Fiber Optic Link)

Introduction

The I/O Link Extender provides the ability to locate 7-Slot or 15-Slot IOP card files and associated FTAs up to 8 kilometers (5 miles) from the HPMM(s). Two types of I/O Link Extenders and their associated fiber optic couplers are available, the “Standard” I/O Link Extender that provides up to a 1.3 kilometer (4000 feet) link, and the “Long Distance” I/O Link Extender which provides up to an 8 kilometers (5 miles) link. The connection is made using a pair of fiber optic transmission cables, driven and terminated by a fiber optic coupler that mates with the connector located directly below the card file slot in which the I/O Link Extender card is installed.

Features

An I/O Link Extender consists of two pairs I/O Link Extender cards, one for Link A and one for Link B, and associated fiber optic couplers at each end of the fiber optic link. The I/O Link Extender cards and their fiber optic couplers occupy two slots in an HPMM or IOP card file.

Remote card files

Every remote card file, or complex of IOP card files, requires two I/O Link Extender cards and two fiber optic couplers, one for Link A and one for Link B.

Fiber optic cable length

The maximum fiber optic cable length is dependent upon the number of splices and quality of the cable (dB loss per meter of cable). This maximum can be between 0.98 and 1.3 kilometers for the Standard I/O Link Extender and 8 kilometers for the Long Distance I/O Link Extender.

I/O Link Extender planning

I/O Link Extender planning can be found in Section 11 in this manual.

Standard I/O Link Extender

Each Standard I/O Link Extender card has an associated fiber optic coupler that can drive up to three pair of fiber optic cables. Each cable pair is terminated by a fiber optic coupler that terminates one fiber optic pair.

The Standard I/O Link Extender card will drive and terminate Link A or Link B, depending upon the card file number and slot number number. If the card file number and slot number number are both odd or both even, the card will drive Link A. If the card file number and slot number number are not both odd or both even, the card will drive Link B.

Two Standard I/O Link Extender cards, connecting up to six remote card files, can be installed in a HPMM card file, but the maximum number of primary IOPs is still 40 (plus 40 redundant IOPs).

Continued on next page

2.4 I/O Link Extender (Fiber Optic Link), Continued

Standard I/O Link Extender connections nonredundant HPMM

Figure 2-10 illustrates the interconnections for a Standard I/O Link Extender in a High-Performance Process Manager that contains a nonredundant HPMM.

Figure 2-10 Standard I/O Link Extender Interconnections with Nonredundant HPMM

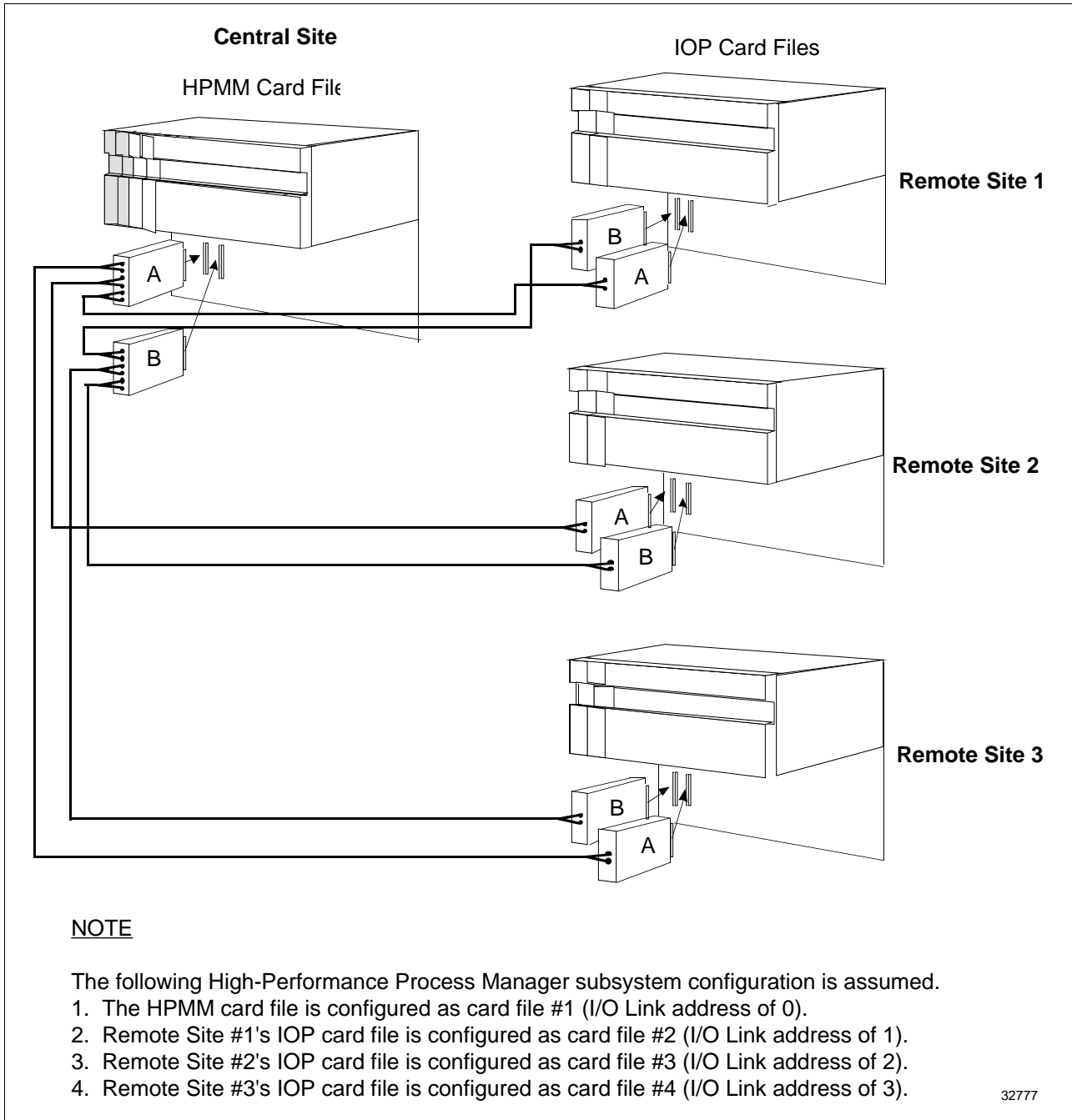

Continued on next page

2.4 I/O Link Extender (Fiber Optic Link), Continued

Standard I/O Link Extender connections redundant HPMMs

Figure 2-11 illustrates the interconnections for a Standard I/O Link Extender in a High-Performance Process Manager that contains redundant HPMMs.

Figure 2-11 Standard I/O Link Extender Interconnections with Redundant HPMMs

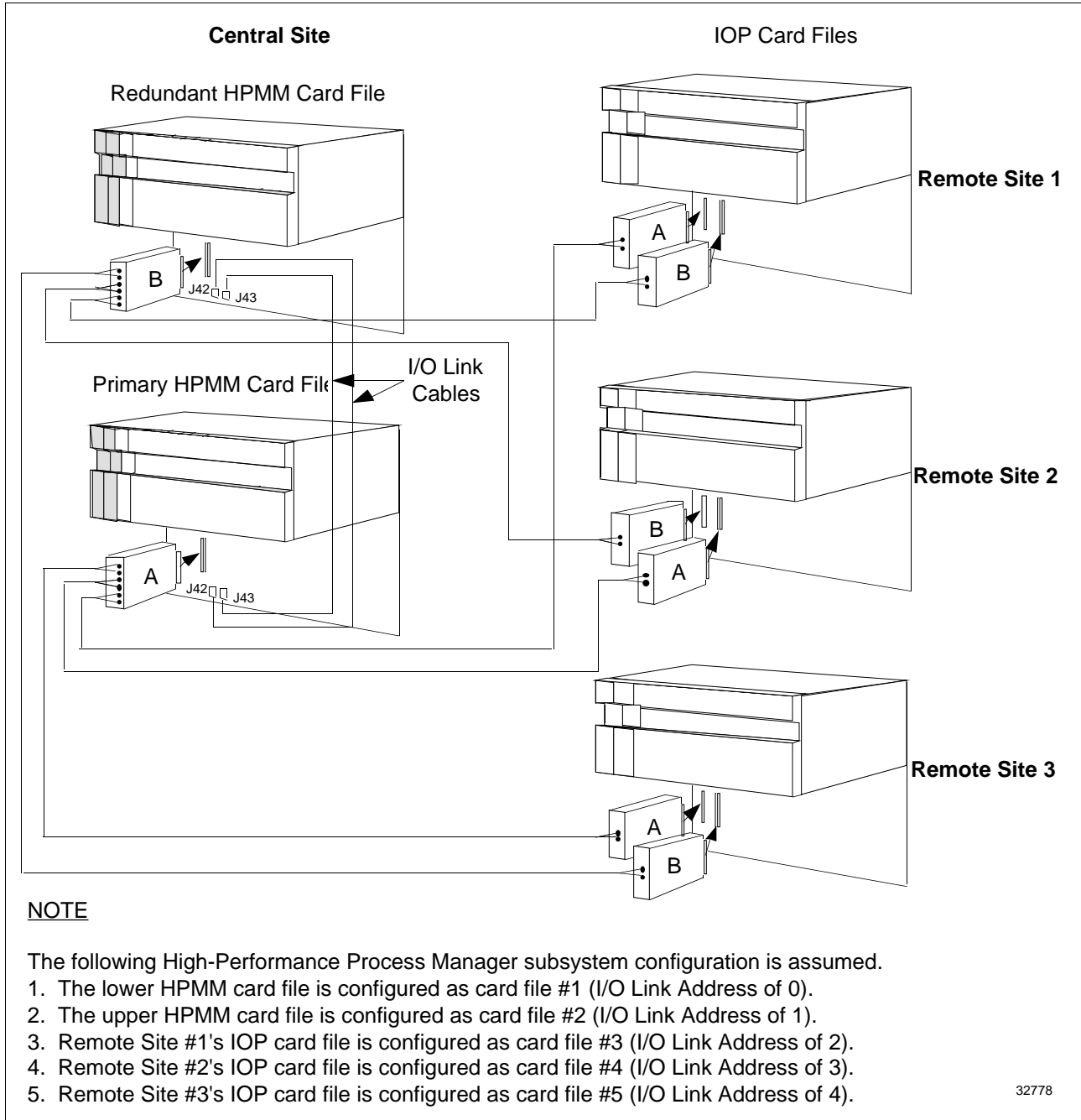

Continued on next page

2.4 I/O Link Extender (Fiber Optic Link), Continued

Long Distance I/O Link Extender

Each Long Distance I/O Link Extender card has an associated fiber optic coupler that drives a single pair of fiber optic cables. Each cable pair is terminated by a fiber optic coupler that terminates one fiber optic pair.

The Link A or Link B selection for the Long Distance I/O Link Extender is determined by a jumper on the card.

Long Distance I/O Link Extender connections nonredundant HPMM

Figure 2-12 illustrates the interconnections for a Long Distance I/O Link Extender in a High-Performance Process Manager that has a nonredundant HPMM.

Figure 2-12 Long Distance I/O Link Extender Interconnections with Nonredundant HPMM

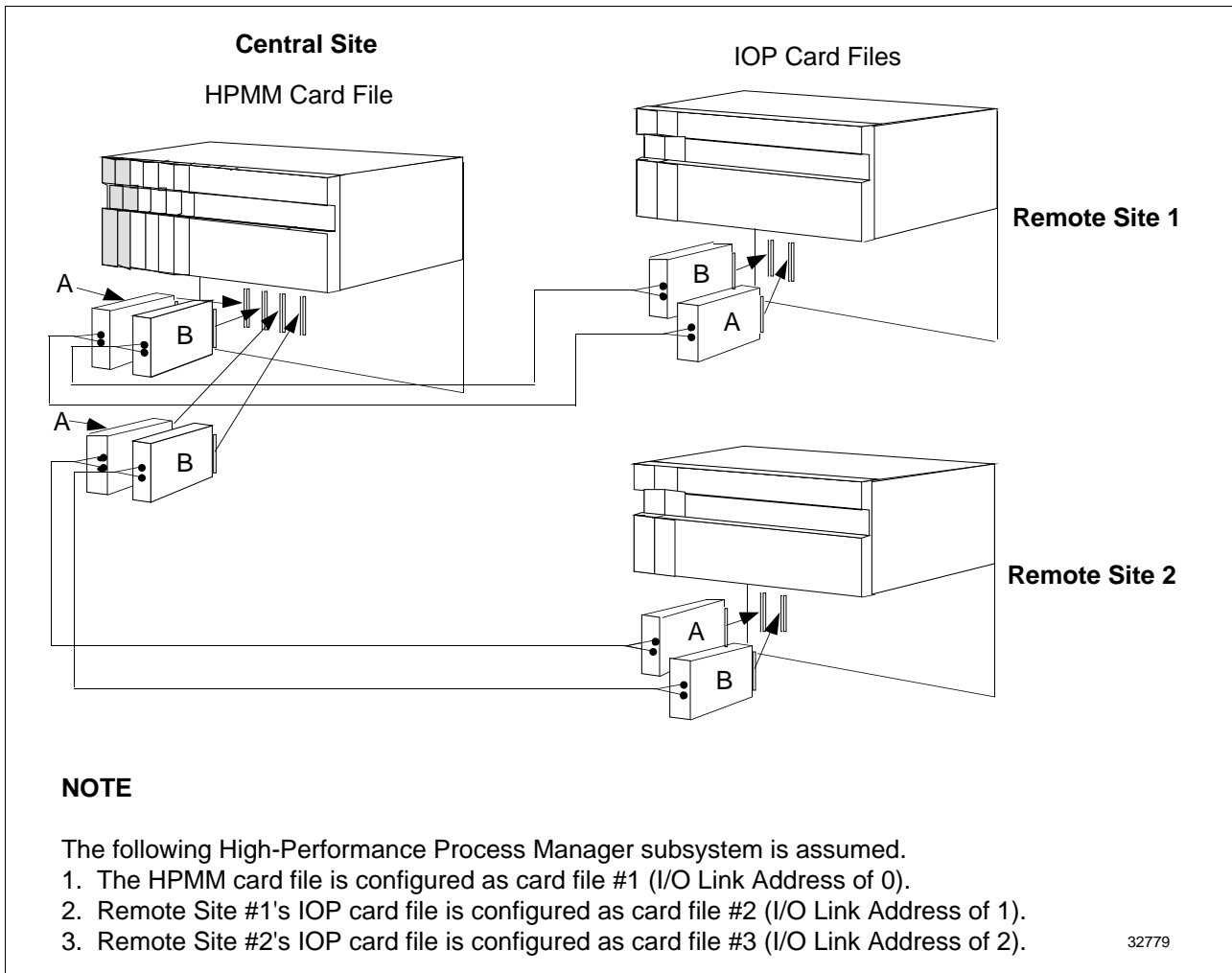

Continued on next page

2.4 I/O Link Extender (Fiber Optic Link), Continued

Long Distance I/O Link Extender connections redundant HPMMs

Figure 2-13 illustrates the interconnections for a Long Distance I/O Link Extender in a High-Performance Process Manager that has redundant HPMMs.

Figure 2-13 Long Distance I/O Link Extender Interconnections with Redundant HPMMs

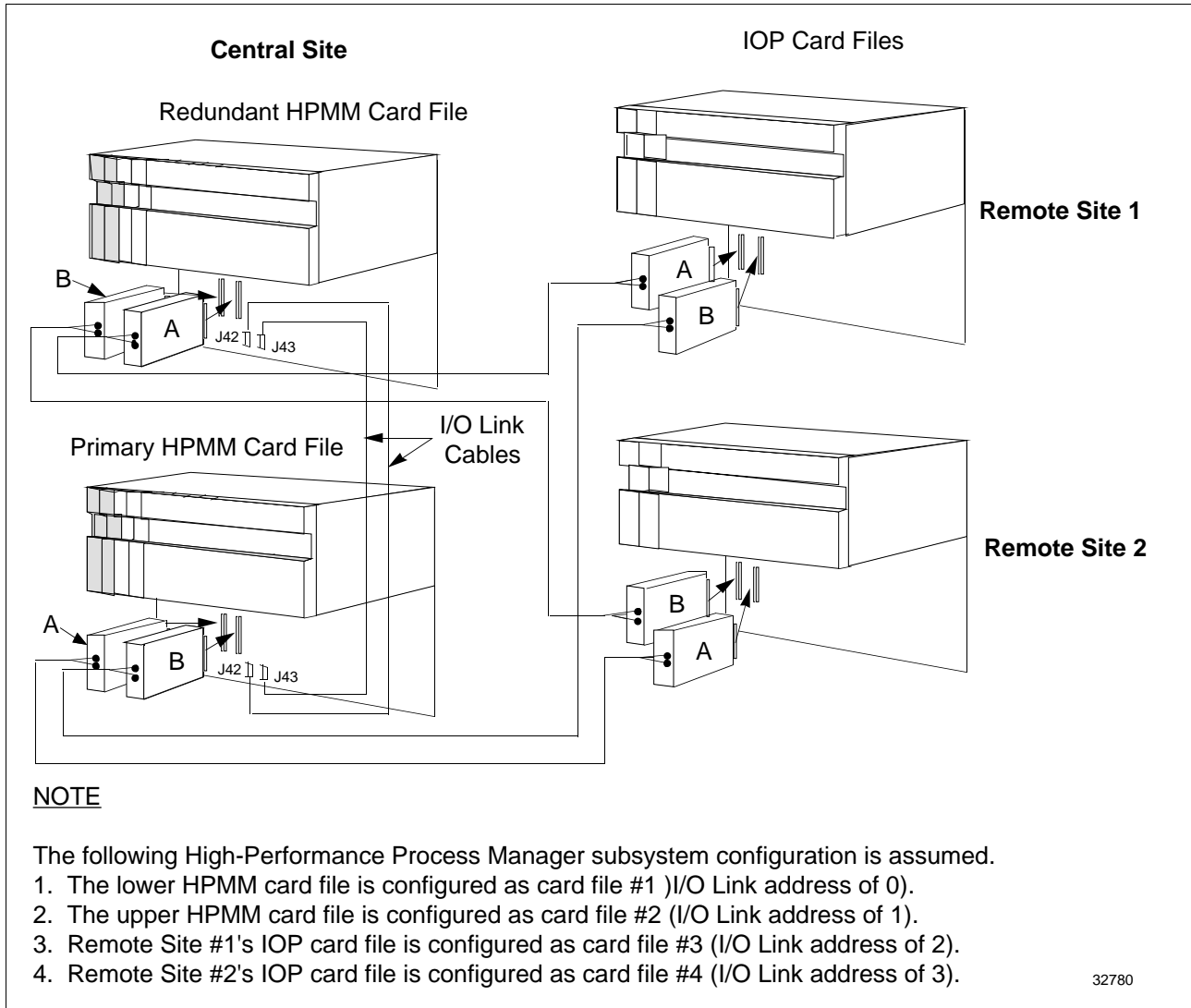

32780

2.5 Field Termination Assemblies (FTAs)

Description	Terminal connectors on the Field Termination Assembly (FTA) provide the connection points for the process control wiring. Fuses, relays, and resistors protect the FTA circuitry, and sense, condition, or operate the connected device. The FTA communicates with an associated IOP, which in turn communicates with the HPMM(s) through the I/O Link Interface.
FTAs types	Standard types of FTAs, as described in Table 2-2, interface the field wiring and provide communication with an associated IOP. They are categorized as “standard” because Galvanically Isolated FTAs are also available as described in Table 2-3.

Continued on next page

2.5 Field Termination Assemblies (FTAs), Continued

Standard FTAs

Standard FTA types are listed in Table 2-2.

Table 2-2 Standard Field Termination Assembly Types

FTA Type	Description
High Level Analog Input/ Smart Transmitter Interface (HLAI/STI)	Accepts high level analog inputs. The inputs are configurable as single-ended or differential in relation to logic ground. The FTA is also used to interface Smart Transmitter devices.
High Level Analog Input (HLAI)	Accepts high level analog inputs. The inputs are configurable as single-ended or differential in relation to logic ground.
Smart Transmitter Interface (STI)	Interfaces with Smart Transmitter devices. The interface is referenced to logic ground. The Smart Transmitter provides field isolation.
Low Level Analog Input (LLAI)	Can be configured to accept low-level or high-level analog inputs. Low-level analog inputs include Thermocouples (TC), Resistance Temperature Detectors (RTDs), or millivolt sources. High-level inputs such as voltage sources (0-5 V) and 4-20 milliamp current loop devices are acceptable. The inputs are isolated from each other and the HPM, but share a common bus for field wire shields.
Low Level Analog Input Multiplexer (LLMux or RHMUX)	The FTA accepts one set of low level analog inputs, such as thermocouples (TC) or Resistance Temperature Detectors (RTDs). The set of inputs must be either thermocouples or RTDs. The inputs are sequentially multiplexed. One or two FTAs of either type can be connected to one Power Adapter assembly and its IOP.
Analog Output (AO)	Provides 4-20 mA analog outputs to proportioning loads such as valves.
120 Vac Digital Input (DI)	Accepts ac digital inputs. All inputs are isolated from each other. Two versions of the FTA are available, with pluggable and without pluggable input modules.
240 Vac Digital Input (DI)	Similar to the 120 Vac DI FTA, except it has a higher operating voltage and a lower sense current. The inputs are in four groups of eight circuits with a common return for each group. Groups are isolated from each other.
24 Vdc Digital Input (DI)	Accepts contacts grouped with an isolated common return. Two versions of the FTA are available, with pluggable and without pluggable input modules.
120/240 Vac Solid-State Digital Output (DO)	Provides solid-state ac digital outputs that are isolated from each other and the HPM.
3-30 Vdc Solid-State Digital Output (DO)	Provides dc digital outputs that are isolated from each other and the HPM.
31-200 Vdc Solid-State Digital Output (DO)	Provides dc digital outputs that are isolated from each other and the HPM.
24 Vdc Nonisolated Digital Output (DO)	Provides nonisolated digital outputs to loads such as lamps and relays. The signals are referenced to logic common.
120 Vac/125 Vdc Relay Digital Output (DO)	Provides independent electromechanical relays for ac or dc digital outputs.

Continued on next page

2.5 Field Termination Assemblies (FTAs), Continued

Standard FTAs, continued

Table 2-2 Standard Field Termination Assembly Types, Continued

FTA Type	Description
240 Vac/125 Vdc Relay Digital Output (DO)	Provides independent electromechanical relays for ac or dc digital outputs.
Pulse Input (PI)	Accepts eight inputs, each with a 32-bit counter, and have a frequency range of dc to 20 kHz. The inputs are referenced to logic ground.
Serial Device interface (SDI Toledo)	The SDI FTA provides an EIA-232 (RS-232) asynchronous serial communications interface for a model 8142-2084 or 8142-2184 Toledo Weigh Cell peripheral manufactured by Toledo Scale Inc.
Serial Device interface (SDI M/A Station)	The SDI FTA provides an EIA-422/485 (RS-422/485) asynchronous serial communications interface for up to four model MU-MASX02 Manual/Auto Station peripherals manufactured by Honeywell Inc.
Serial Device interface (SDI UDC 6000)	The SDI FTA provides an EIA-422/485 (RS-422/485) asynchronous serial communications interface for up to four UDC 6000 Modbus peripherals manufactured by Honeywell Inc.
Serial Interface (SI Modbus RTU)	The SI FTA provides either an EIA-232 (RS-232) asynchronous serial communications interface for one Modbus compatible device or an EIA-422/485 (RS-422/485) asynchronous serial communications interface for up to 15 Modbus RTU compatible devices.
Serial Interface (Allen-Bradley)	The SI FTA accommodates a single EIA-232 compatible Allen-Bradley device through its EIA-232 interface.

Continued on next page

2.5 Field Termination Assemblies (FTAs), Continued

Galvanically Isolated FTAs

Galvanically Isolated FTA types are listed in Table 2-3.

Table 2-3 Galvanically Isolated Field Termination Assembly Types

FTA Type	Description
Remote Hardened Low Level Analog Input Multiplexer (RHMUX)	Accepts one set of low-level analog inputs. The inputs are sequentially multiplexed and can be either thermocouple (TC) or millivolt (Mv). One or two FTAs can be connected to its Power Adapter assembly and IOP.
Remote Hardened Multiplexer Non-Incendive Power Adapter (RHMUX NIPA)	The RHMUX NI Power Adapter provides the interface between an RHMUX IOP and one or two RHMUX FTAs, which can be mounted in a Division 2, Zone 1, or nonhazardous location.
Remote Hardened Multiplexer Intrinsically Safe Power Adapter (RHMUX ISPA)	The RHMUX IS Power Adapter provides the interface between an RHMUX IOP and one or two RHMUX FTAs, which can be mounted in a Division 1 or Zone 0 location.
High Level Analog Input (HLAI/STI)	The HLAI/STI FTA accepts high level analog inputs. All inputs are isolated from ground and each other. The FTA is also used to interface Smart Transmitter devices.
High Level Analog Input (HLAI)	The HLAI FTA accepts high level analog inputs. All inputs are isolated from ground and each other.
24 Vdc Digital Input (DI)	The 24 Vdc DI FTA accepts contact inputs. All inputs are isolated from each other.
Analog Output (AO)	The AO FTA provides isolated 4-20 mA outputs to proportioning loads such as valves.
24 Vdc Digital Output (DO)	The 24 Vdc DO FTA provides isolated digital outputs to loads such as solenoid valves or lamps.

Continued on next page

2.5 Field Termination Assemblies (FTAs), Continued

Three physical sizes

The standard FTAs have three physical sizes as illustrated in Figure 2-14. The Galvanically Isolated FTAs are one size only, B-size.

Figure 2-14 Field Termination Assembly (FTA) Sizes

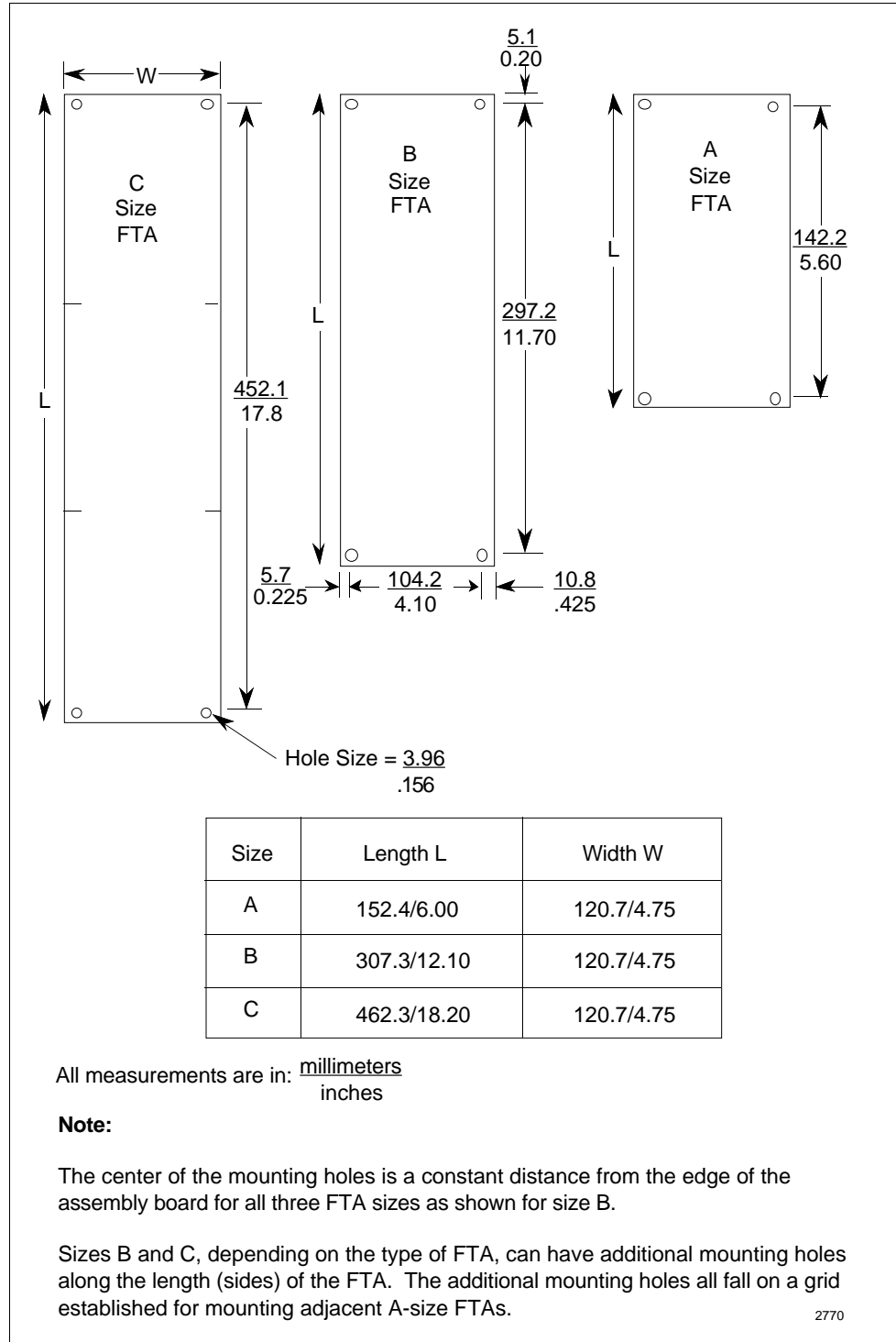

Continued on next page

2.5 Field Termination Assemblies (FTAs), Continued

FTA Mounting Channels

The FTAs are installed at the rear or front of a dual-access cabinet on one or more FTA Mounting Channels. In a single-access cabinet, the FTAs are mounted on FTA Mounting Channels at the front of the cabinet. The FTA Mounting Channels also function as cable and wiring channels, or troughs. The standard and Galvanically Isolated FTAs must not be mounted on the same FTA Mounting Channel. Mounting both types of FTAs on the same FTA Mounting Channel is an Intrinsic Safety violation because the field wiring must not be routed in the same channel.

Mounting orientation

Both standard (non-Galvanically Isolated) and Galvanically Isolated FTAs can be mounted on vertically oriented 3-foot long FTA Mounting Channel segments; however, Standard and Galvanically Isolated FTAs must not be mounted on the same FTA Mounting Channels.

Galvanically Isolated FTAs can be mounted on an FTA Mounting Channel that is above or below an FTA Mounting Channel that has standard FTAs mounted on it.

Optionally, Galvanically Isolated FTAs can also be mounted on horizontally oriented 2-foot long FTA Mounting Channels. Standard FTAs must not be mounted on horizontal FTA Mounting Channels.

Continued on next page

2.5 Field Termination Assemblies (FTAs), Continued

Typical cabinet layout

A typical cabinet layout of FTA Mounting Channels that demonstrates the installation of standard FTAs in a dual-access High-Performance Process Manager cabinet is shown in Figure 2-15.

Figure 2-15 Typical Vertical FTA Mounting Channel Layout

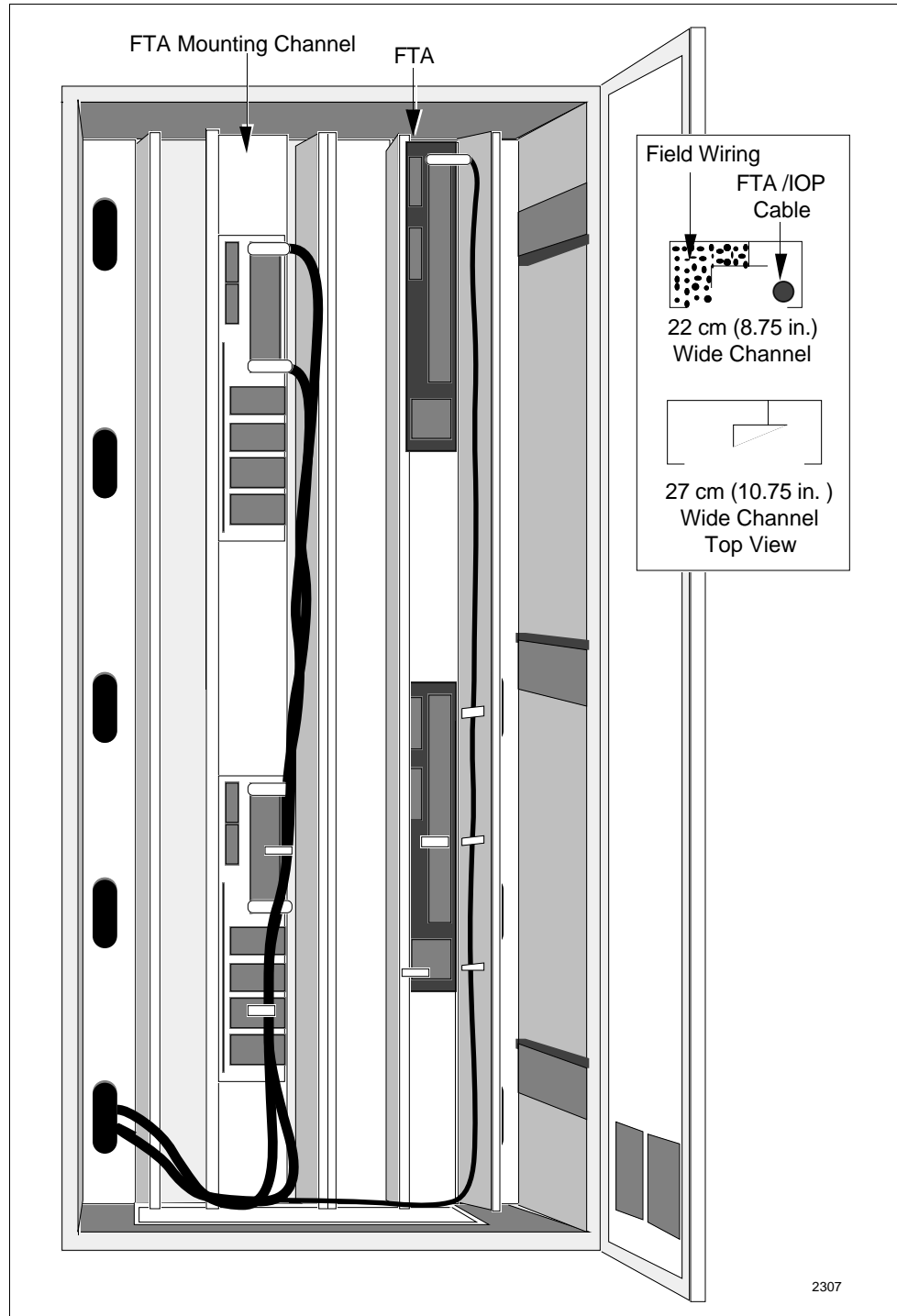

Continued on next page

2.5 Field Termination Assemblies (FTAs), Continued

Compression or screw terminals available

Most standard FTA types are available with either compression-type or screw-type terminal connectors. Some exceptions are the 6-inch Analog Output (AO), 6-inch High Level Analog Input (HLAI), 6-inch Low Level Analog Input Multiplexer (LLMux), and the 6-inch Digital Input Power Distribution Assembly, which are available with compression-type terminal connectors only. The Remote Hardened Low Level Analog Input Multiplexer (RHMUX) mounts in a separate enclosure and is available only with screw-type terminal connectors. The number of terminals for both the compression-type and screw-type terminal connector can vary depending on the type of standard FTA.

All Galvanically Isolated FTAs are available with both crimp pin-type and compression-type terminal connectors. The Marshalling Panel that is used with Galvanically Isolated FTAs is available only with screw-type terminal connectors. See Section 15 for a description of the Marshalling Panel.

FTA compression-type terminal connector

Figure 2-16 is an illustration of a typical compression-type terminal connector connection to a standard FTA.

Figure 2-16 Typical FTA Compression Terminal Connector

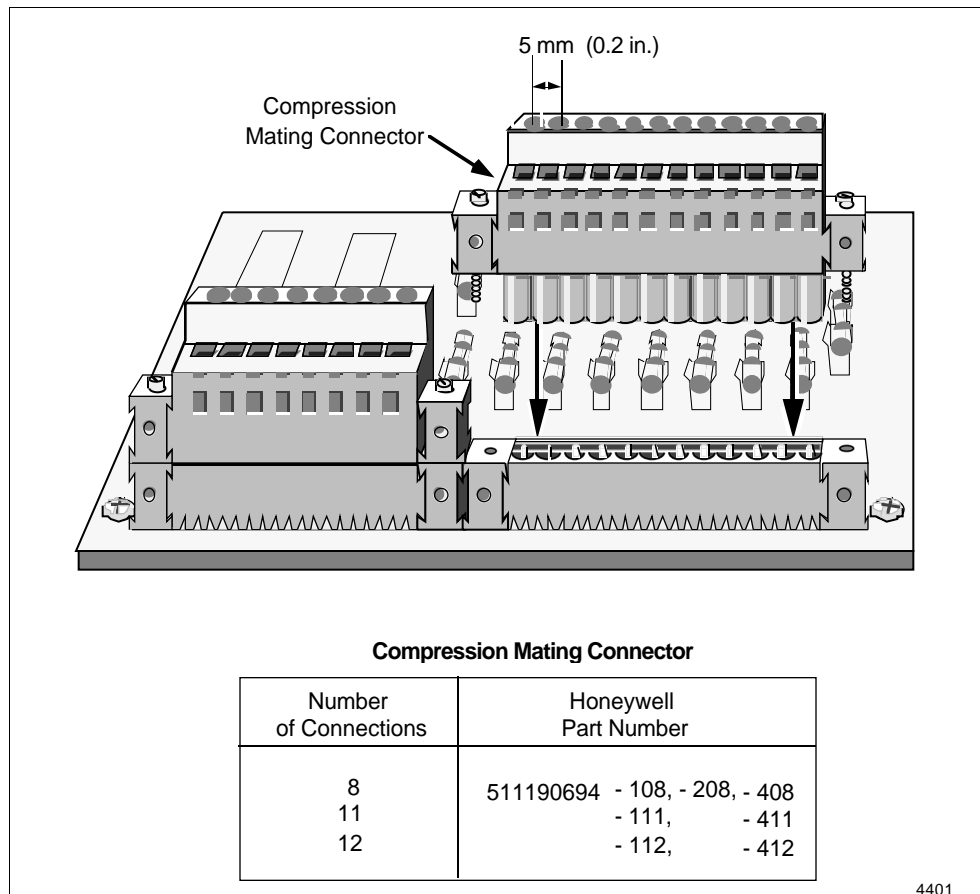

4401

Continued on next page

2.5 Field Termination Assemblies (FTAs), Continued

FTA fixed-screw terminal connector

Figure 2-17 illustrates a typical fixed-screw terminal connector as it would appear on a standard FTA.

Figure 2-17 Typical FTA Fixed-Screw Terminal Connector

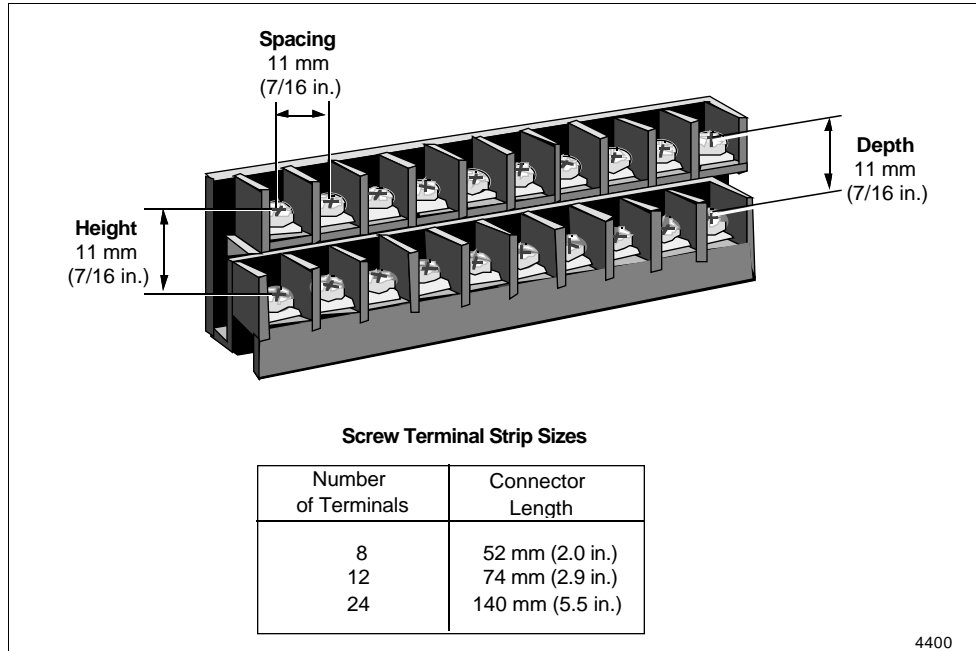

FTA removable-screw connector

Figure 2-18 illustrates a typical removable-screw terminal connector.

Figure 2-18 Typical FTA Removable-Screw Terminal Connector

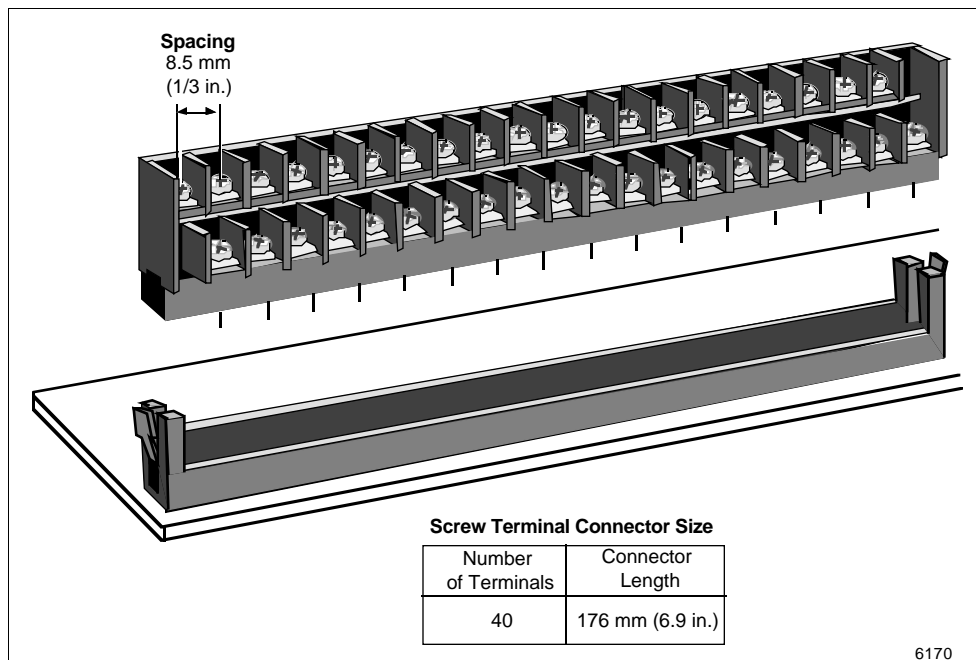

Continued on next page

2.5 Field Termination Assemblies (FTAs), Continued

Galvanic Isolation Module connectors

Figures 19 and 20 illustrate the crimp pin-type and compression-type terminal connectors for the Galvanically Isolated FTAs, respectively. The connectors on the Galvanic Isolation Modules have six terminals. Depending on the type of terminal connector, the terminals accept size 0.3 to 3.5 mm² (12 to 22 AWG) wiring.

Crimp pin-type terminal connector

Figure 2-19 illustrates the crimp-pin type Galvanic Isolation Module terminal connector.

Figure 2-19 Crimp-Pin Galvanic Isolation Module Terminal Connector

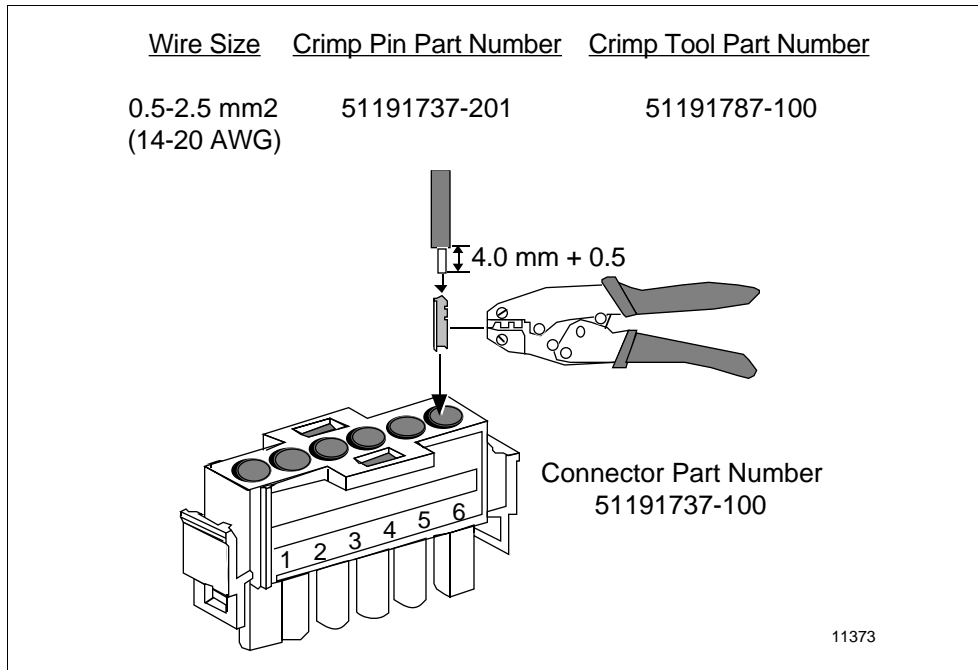

Continued on next page

2.5 Field Termination Assemblies (FTAs), Continued

Compression-type terminal connector

Figure 2-20 illustrates the compression-type Galvanic Isolation Module terminal connector.

Figure 2-20 Compression-Type Galvanic Isolation Module Terminal Connector

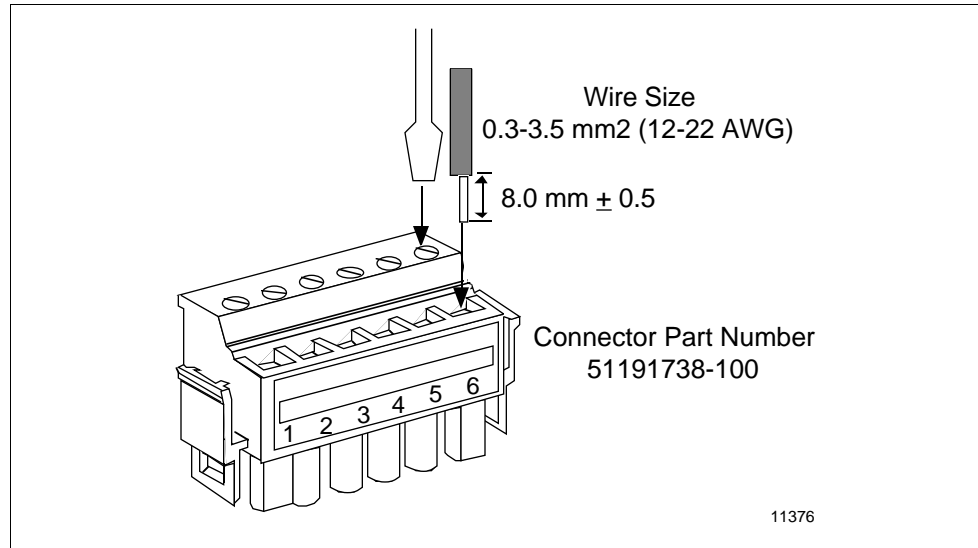

Continued on next page

2.5 Field Termination Assemblies (FTAs), Continued

Marshalling Panel

The Marshalling Panel was developed to provide access to the signals from the auxiliary connectors on the Galvanically Isolated FTAs. It can also be used as a general purpose Marshalling Panel in the High-Performance Process Manager subsystem.

Figure 2-21 illustrates an assembly layout of the panel. The Marshalling Panel, model MU-GMAR52, is similar in shape and appearance to a “B” size FTA (see Figure 2-14). The assembly provides surge and ESD protection for the field wiring terminals. A 50-pin connector is provided on the assembly that accepts an IOP to FTA cable.

Figure 2-21 FTA Marshalling Panel Assembly Layout

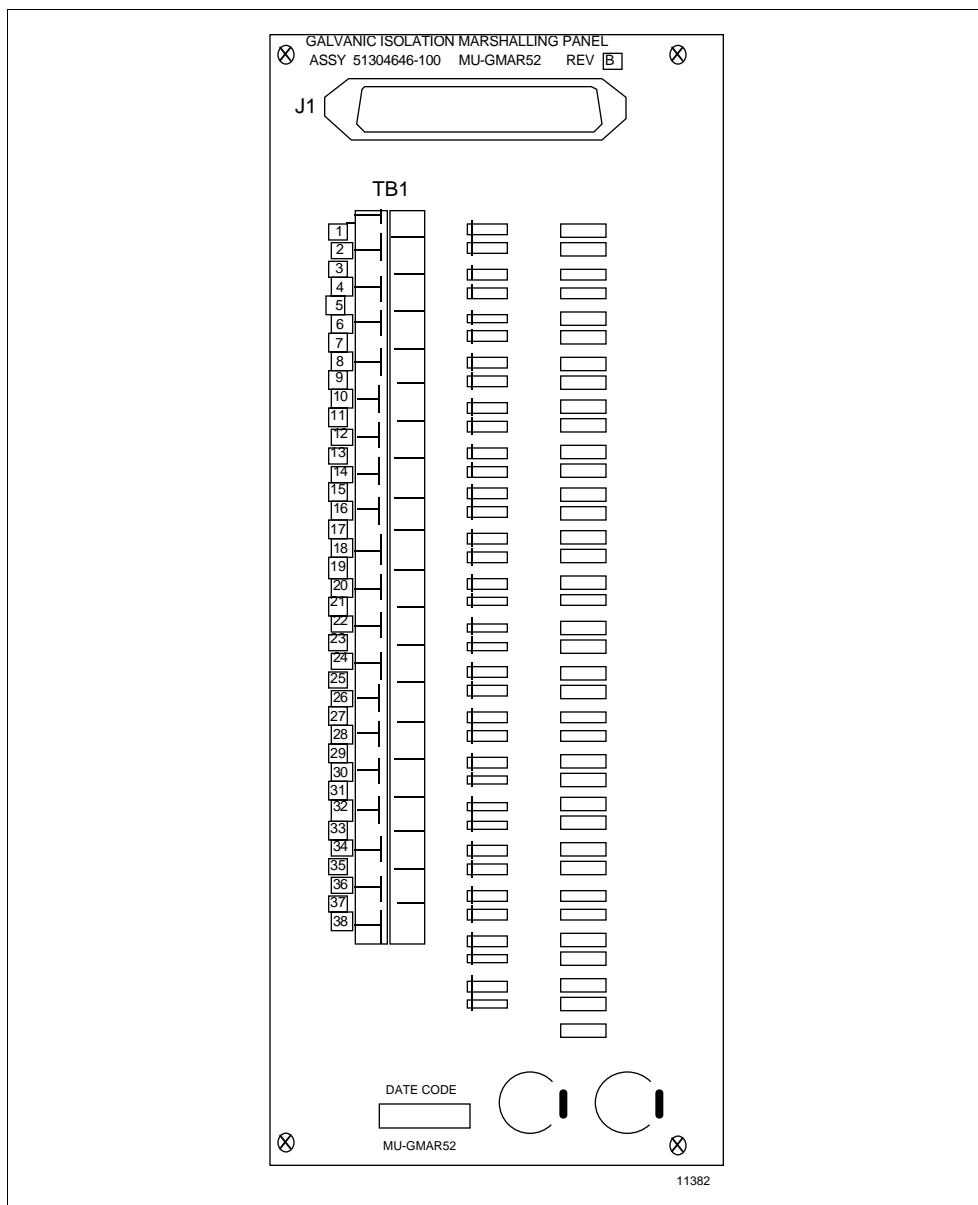

2.6 Power Systems

- Power System features** The High-Performance Process Manager Power System provides
- 24 Vdc power for operation of all HPMM cards, IOP cards, and FTAs
 - A nominal 3.6 Vdc battery output for backup of the HPMM and IOP memory circuits.
 - A nominal 0.25 ampere, 6 Vac output for operation of a LLAI line frequency clock circuit.
-

- Two types of Power Systems** There are two types of Power Systems.
- Standard Power System
 - AC Only Power System
-

- Standard Power System** The Standard Power System has many features that include
- An optional redundant Power Supply Module (model MU-PSRX03/04).
 - Either 120 Vac or 240 Vac input power. A single or dual source of input power can be connected when the optional redundant Power Supply Module option is implemented.
 - Single and redundant Power Supply Module failure detection.
 - CMOS memory NiCad battery backup (3.6 Vdc) for 12 hours (model MU-PSRX03) or 45 hours (model MU-PSRX04) backup with failure detection.
 - An optional 48 Vdc Battery Backup Module (model MU-PSRB03/04) with a disconnect switch that backs up the 24 Vdc for 25 minutes.
-

Redundant Power Supply Modules Redundant Power Supply Modules are recommended when the Power System provides power for redundant HPMMs. If the redundant HPMMs are resident in separate cabinets with their own Power System, a Power System with a single Power Supply Module is acceptable, though not fully recommended.

Continued on next page

2.6 Power Systems, Continued

Model MU-PSRX03 Standard Power System

The layout of the model MU-PSRX03 Standard Power System is illustrated in Figure 2-22.

Figure 2-22 Standard Power System—Model MU-PSRX03

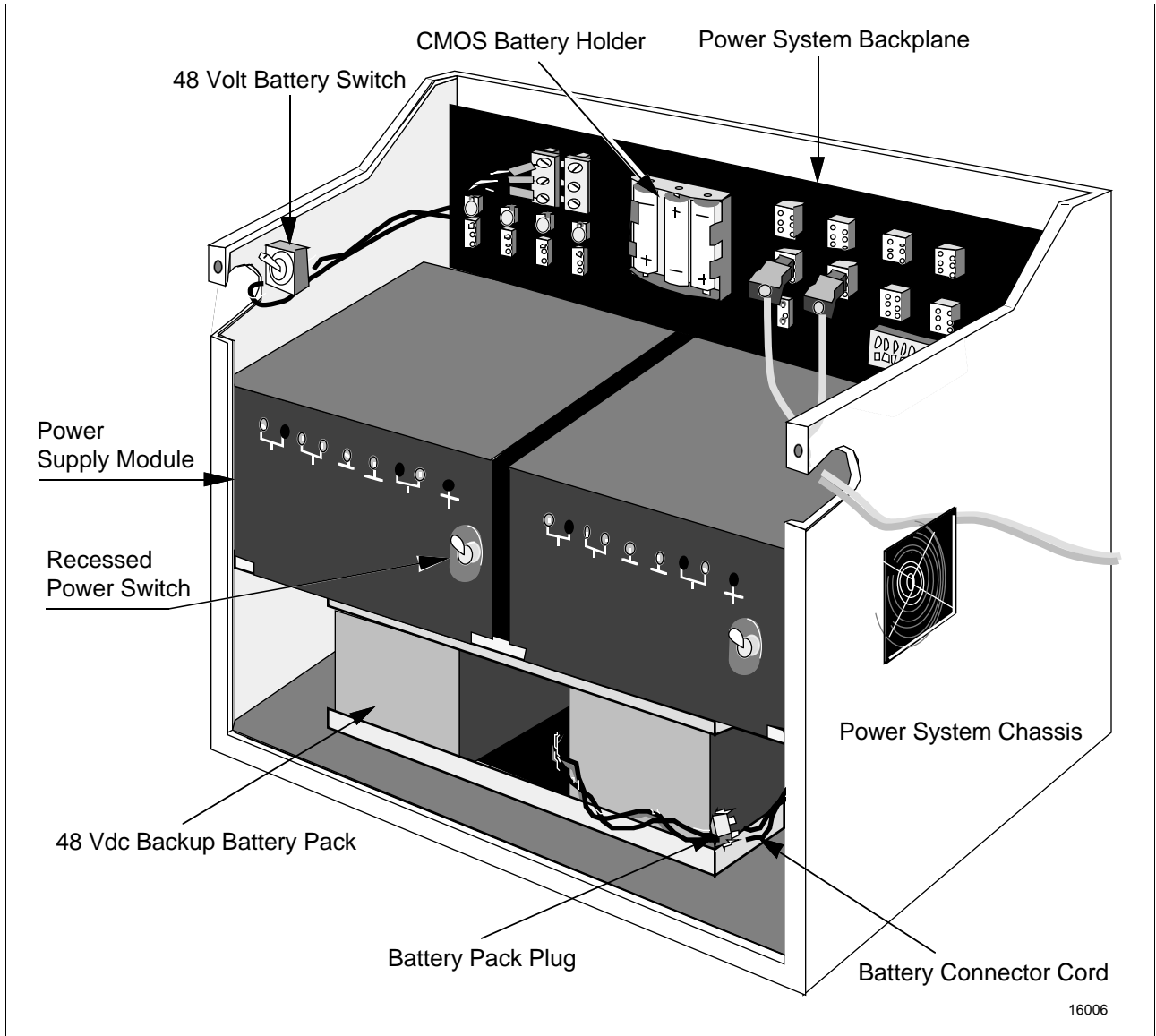

Continued on next page

2.6 Power Systems, Continued

Model MU-PSRX04 Standard Power System

The layout of the model MU-PSRX04 Standard Power System is illustrated in Figure 2-23.

Figure 2-23 Standard Power System—Model MU-PSRX04

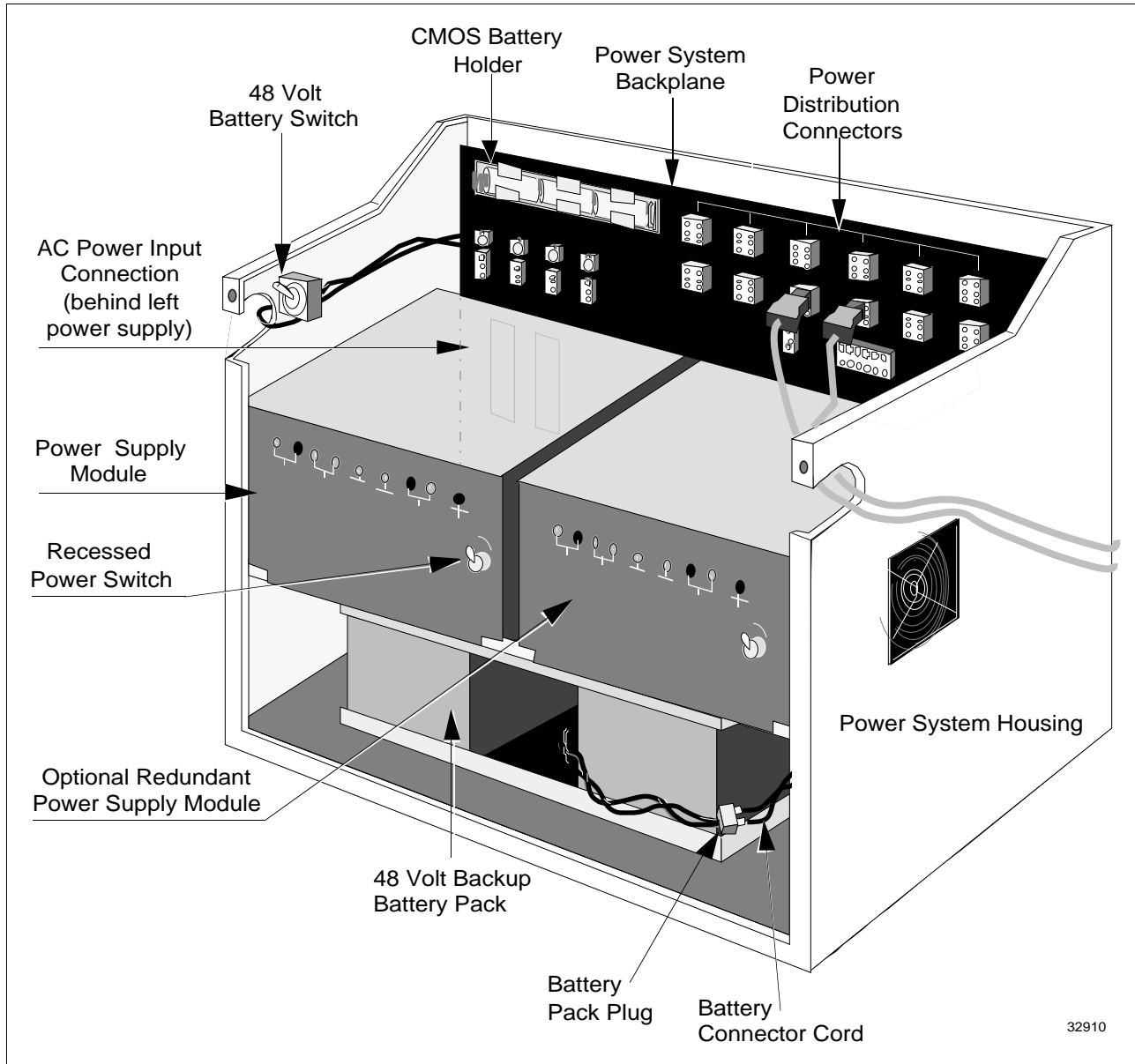

Continued on next page

2.6 Power Systems, Continued

AC Only Power System The AC Only Power System offers optional 8- or 16-ampere redundant Power Supply Modules, but does not offer the optional 48 Vdc Battery Backup module feature and rechargeable NiCad CMOS memory backup power.

Alkaline batteries are used instead of rechargeable NiCad batteries for CMOS data retention in the AC Only Power System.

ATTENTION

ATTENTION—The AC Only Power System must not be used in CE Compliant applications.

Continued on next page

2.6 Power Systems, Continued

AC Only Power System illustration The layout of the AC Only Power System is illustrated in Figure 2-24.

Figure 2-24 AC Only Power System—Not for CE Compliant Applications

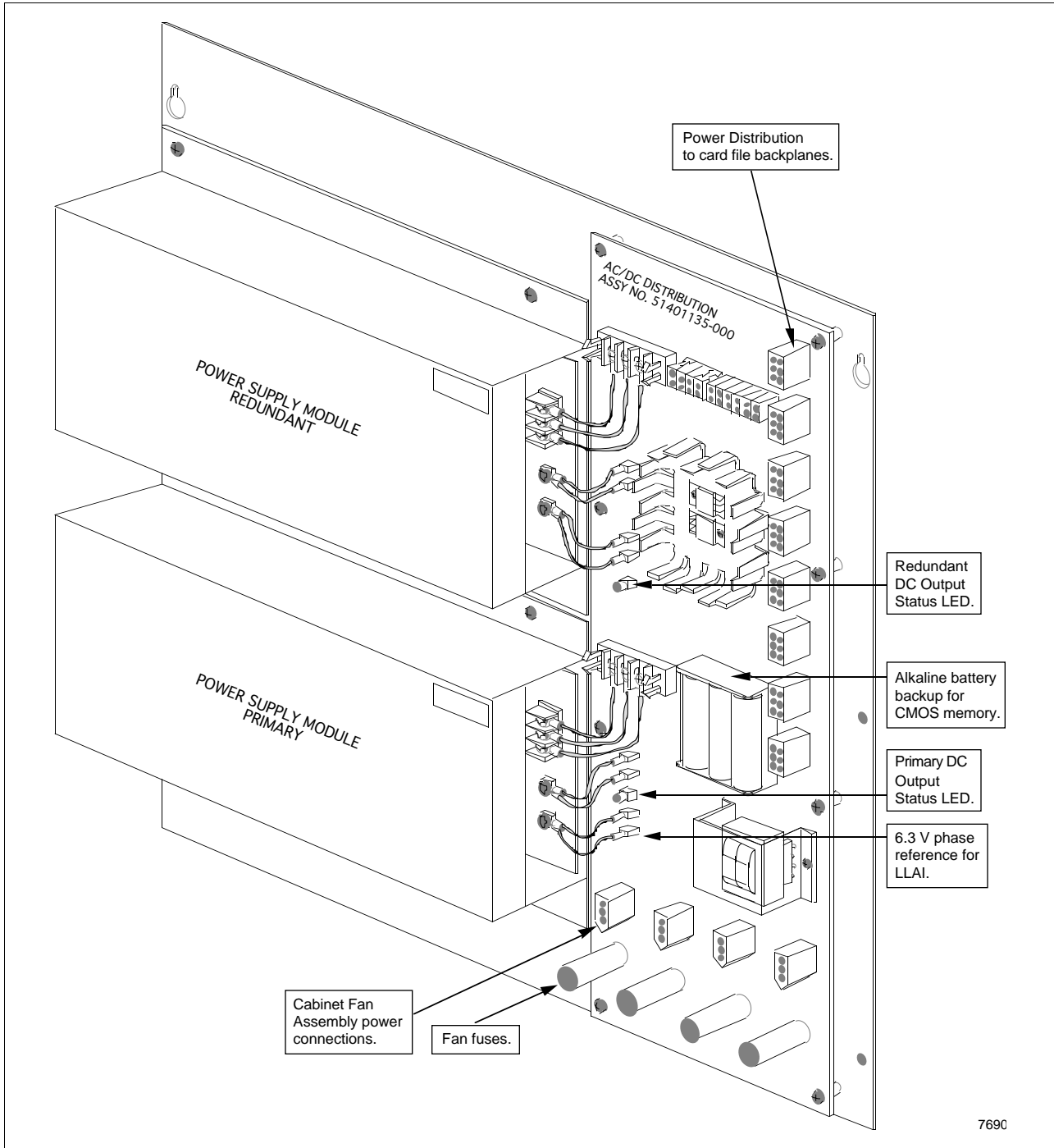

2.7 Cabinet Configurations

Cabinet configurations The High-Performance Process Manager subsystem can have various cabinet configurations. Cabinets can be complexed together or remotely separated. The HPMM and IOP card files can share the same Power System or have independent Power Systems. If the HPMMs share the same Power System, the Power System should contain redundant Power Supply Modules.

Continued on next page

2.7 Cabinet Configurations, Continued

Redundant HPMMs in a single cabinet

Figure 2-25 is an illustration of a single High-Performance Process Manager cabinet containing two HPMM card files in a redundant HPMM configuration and one IOP card file. The HPMM card files and the IOP card file share the same Power System.

Figure 2-25 Single Cabinet with Redundant HPMMs

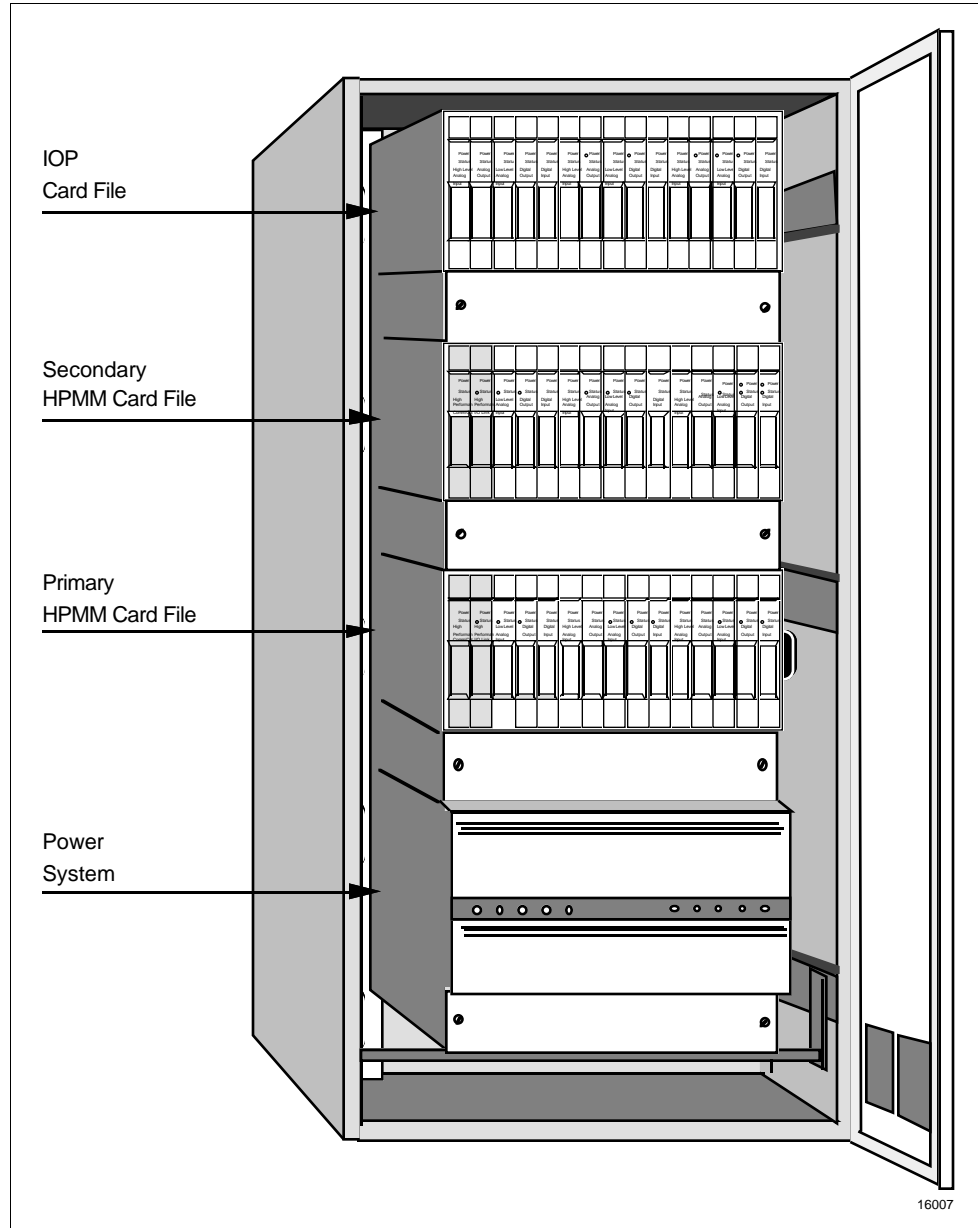

Continued on next page

2.7 Cabinet Configurations, Continued

Redundant HPMMs in complexed cabinets

Two cabinets that are complexed together is illustrated in Figure 2-26. The redundant pair of HPMM card files are installed in separate cabinets. The purpose is to provide independent power for the HPMM card files and their associated IOP card files.

Figure 2-26 Complexed Cabinets with Redundant HPMMs

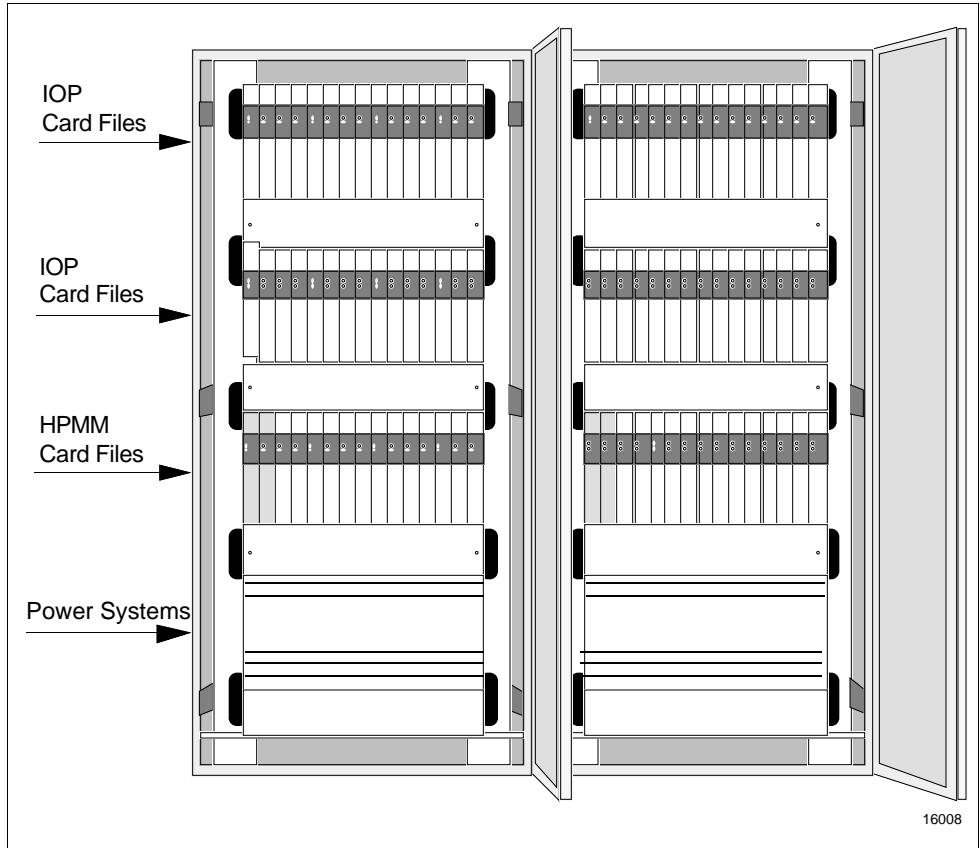

Continued on next page

2.7 Cabinet Configurations, Continued

Local and remote HPM cabinets

Figure 2-27 illustrates a 2-cabinet complex with redundant HPMM card files and a remote cabinet that contains IOP card files. Communication with the remote cabinet is provided by fiber optic I/O Link Extenders.

Figure 2-27 Local Complexed Cabinets with Redundant HPMMs and a Remote I/O Cabinet

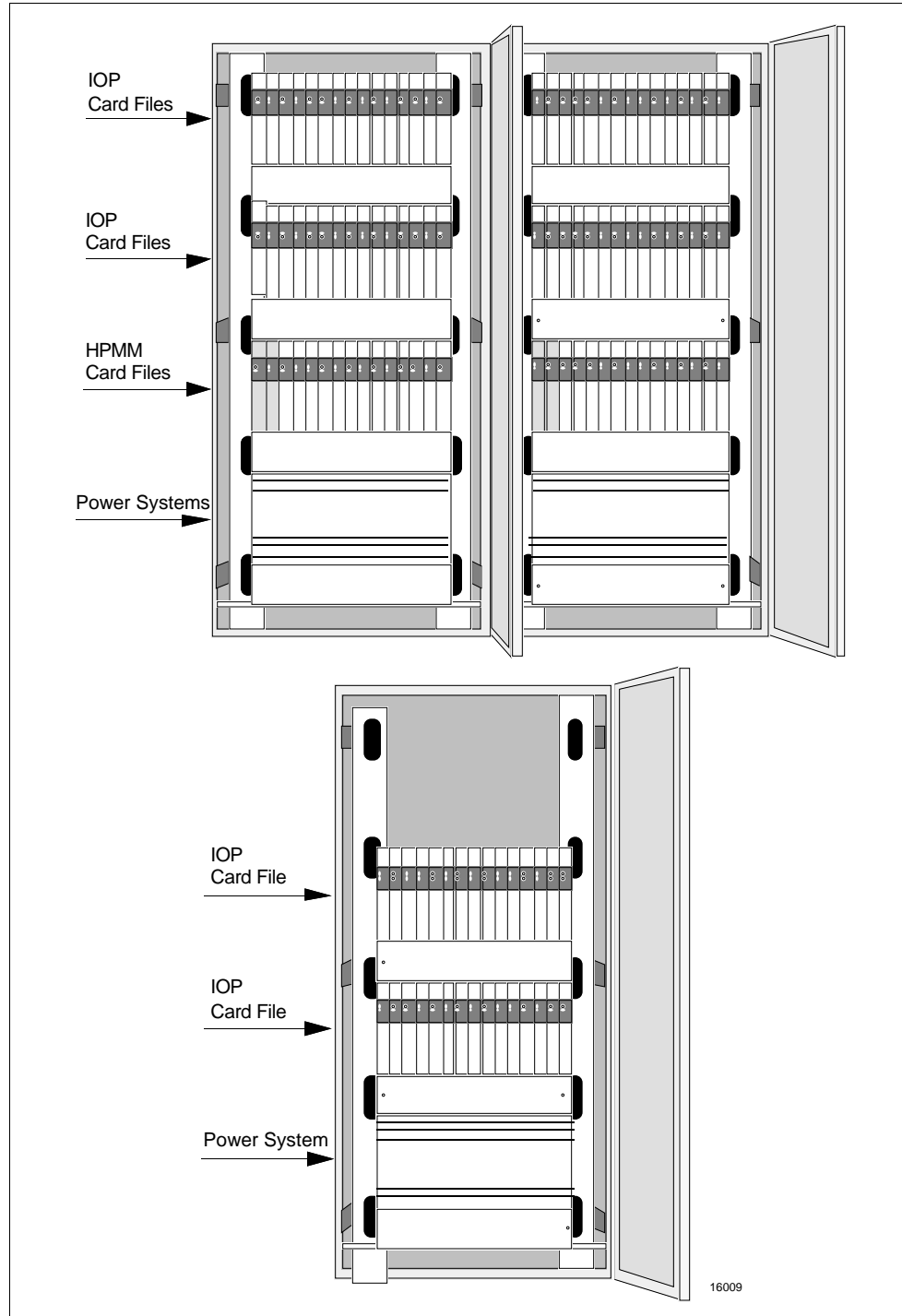

Section 3 – Power Requirements

3.1 Overview

Section contents The topics covered in this section are:

	Topic	See Page
3.1	Overview.....	45
3.2	Backup Strategy.....	46
3.3	Quality.....	48
3.4	Power Draw.....	51
3.4.1	Typical 24 Vdc Power Draw Calculations.....	53
3.4.2	Single Power System Calculation Example.....	58
3.4.3	Dual Power System Calculation Example.....	59
3.4.4	HPM AC Power Draw.....	60
3.4.5	Crest Factor.....	61
3.4.6	Inrush Current.....	62
3.5	Substation Sizing.....	64
3.6	Circuit Breaker Sizing.....	65
3.7	Custom UPS and Power Factor.....	66
3.8	Automatic Bypass Switch.....	66
3.9	Surge Protection.....	67
3.10	Grounded Conductor.....	68
3.11	Redundant Safety Grounds.....	68
3.12	Emergency Shutdown.....	68
3.13	Trays and Conduits.....	68
3.14	Existing TPS System AC Power.....	69

Introduction

This section provides the user with information to plan adequate ac power service for his High-Performance Process Manager (HPM) subsystem. The section also aids the user in planning a power backup strategy when the primary source fails.

Power backup planning

A well planned power system for the High-Performance Process Manager minimizes subsystem downtime. In this section, we explore various paths for handling the loss of subsystem ac power. The selected path dictates whether a given HPM needs the optional dual Power Supply Modules and/or a battery backup for the 24 Vdc. This definition of the power equipment in an HPM allows the ac power system requirements to be defined in detail.

3.2 Backup Strategy

Planning strategy	<p>There are several planning strategies for handling a loss of ac power to the HPM. This strategy takes advantage of any or all of the following:</p> <ul style="list-style-type: none">• An optional battery backup for the 24 Vdc• An optional secondary Power Supply Module• An optional automatic ac transfer switch• An Uninterruptible Power Supply (UPS)
Power continuity	<p>Power continuity is established by the use of the optional battery backup for 24 Vdc. This battery backup option is available with the redundant Power Supply Module option. When an ac power loss occurs, the battery carries a full load of 20 amperes for minimum of 25 minutes. If 25 minutes is not sufficient, consider another backup source to provide ac power.</p>
Two ac power sourcing methods	<p>There are two methods in which two separate sources of ac power for an HPM subsystem can be implemented.</p>
First method	<p>The first method takes advantage of the HPM's redundant Power Supply Module option. The two Power Supply Modules can be wired to operate from two separate ac feeder sources as illustrated in Figure 3-1 or 3-2. The two ac feeder sources do not have to be of the same phase, frequency, voltage, or from the same service as long as each meets the power quality requirements discussed in subsection 3.3.</p>
Second method	<p>The second method, by which two ac feeder sources can be implemented, is through an automatic transfer switch. The HPM does not need redundant Power Supply Modules or dual ac feeders for this approach because the transfer switch provides only one ac output. The automatic transfer switch can detect an ac failure and execute a transfer of its load from one service to another in 5 milliseconds. The HPM will perform without compromise even if this cycle requires 10 milliseconds.</p>
Better continuity of HPM power	<p>The use of the battery backup option in an HPM with redundant Power Supply Modules further enhances the continuity of power.</p>

Continued on next page

3.2 Backup Strategy, Continued

Uninterruptible Power Supply (UPS)

A second source of ac power can come from a public utility, another plant, or can be generated from an Uninterruptible Power Supply (UPS). In any case, an automatic or manual transfer switch is needed to complete the installation. Consider the case in which a nearby public utility ac feeder provides backup for the process facility steam plant. An automatic transfer switch should be installed to transfer from the steam plant's ac feeder to the public utility's ac feeder. A switch with maximum transfer time of 10 ms in both directions is recommended. The UPS offers even more possibilities.

UPS description

The UPS consists of a battery charger, a large battery, and a chopper to convert the battery's dc power into quality ac power. The UPS is always on and is always supplying power to its load through the battery that is on a float charge. Should the ac input fail, the UPS continues to serve the load without any changes and it will continue to operate until the battery is discharged, or the ac input to the UPS charger is restored. The capacity of the battery pack is specified by the UPS manufacturer and will provide many hours of backup.

UPS transfer switches

The UPS usually has two transfer switches. A switch on the output of the UPS automatically transfers the loads to plant power in case of failure in the UPS. A second transfer switch to the UPS input charger allows manual transfer to public utility power if there is extended failure of plant power. A UPS with two ac sources provides the means for several backup strategies. The HPM offers additional permutations with its optional redundant Power Supply Modules, dual-feeds, and battery backup. The need for all of this backup redundancy depends on how important it is to have a working control system when plant power is out for an extended period.

Power quality

After the overall power system strategy is selected, the quality and the quantity of power must next be determined.

3.3 Quality

Quality requirements

The HPM is typically connected to ac power as illustrated in Figure 3-1 or 3-2. It operates on any ac source that meets the following requirements:

- Voltage: 100-132/187-264 Vac, single phase
 - Frequency: 47-63 Hz
 - Total Harmonic Distortion (THD): 8% maximum
 - Power dropout: 10 ms maximum
-

Verification

Techniques and equipment for verifying the above electrical power system parameters are described in the *High-Performance Process Manager Checkout* manual. Existing instrument power at most sites usually meets the above requirements.

Continued on next page

3.3 Quality, Continued

AC power and ground Figure 3-1 illustrates the ac power and ground connections for a typical multi-ground HPM installation that includes Master Reference Ground (MRG). The ground system is non-CE Compliant.

Figure 3-1 Subsystem AC Power and Ground Connections—Multi-Ground System

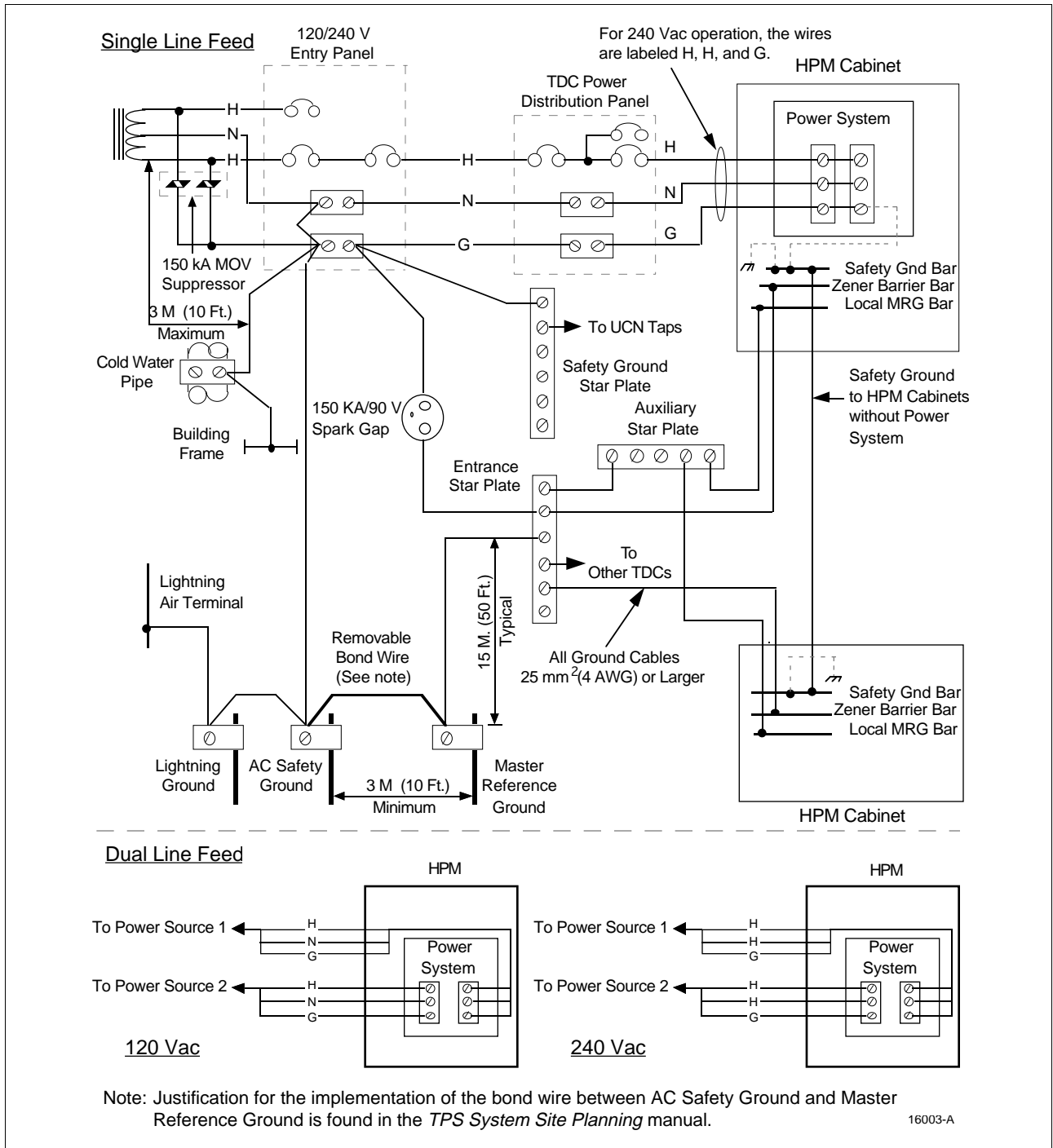

Continued on next page

3.3 Quality, Continued

AC power and ground Figure 3-2 illustrates the ac power and ground connections for a typical single-ground HPM installation that is designated Safety Ground. The Safety Ground system is CE Compliant.

Figure 3-2 Subsystem AC Power and Ground Connections—Single-Ground System

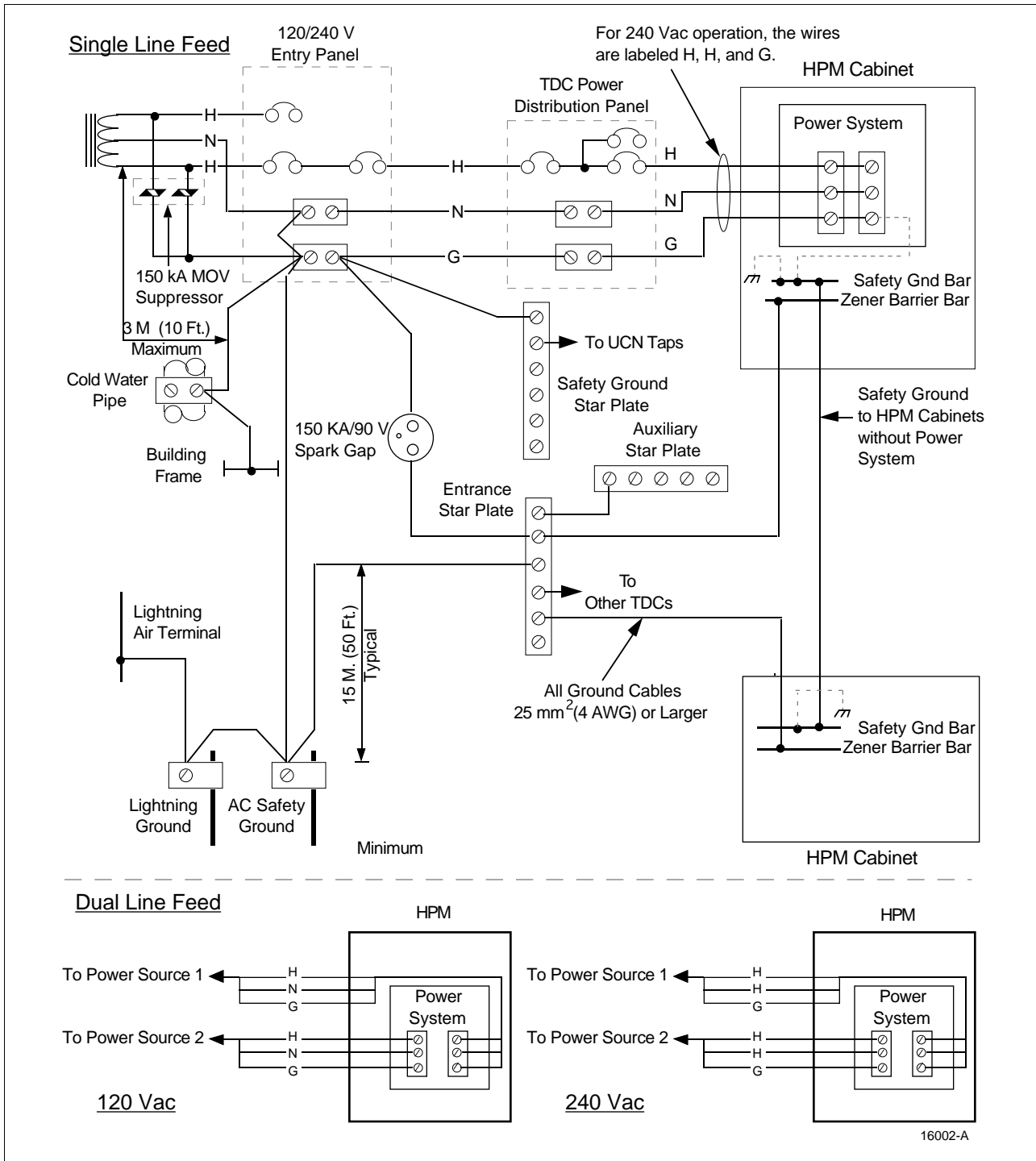

3.4 Power Draw

Introduction

The power requirements for a High-Performance Process Manager (HPM) can necessitate the installation of one or more Power Systems in a cabinet complex. This requirement depends on the number and types of High-Performance Process Manager Modules (HPMMs), Input Output Processors (IOPs), and Field Termination Assemblies (FTAs) in the subsystem. In a large High-Performance Process Manager subsystem with redundant HPMMs and redundant IOPs, it may be desirable to install the HPMMs in separate cabinets with a Power System in each cabinet. With this configuration, a power failure in one Power System does not result in the failure of both the primary and secondary HPMMs and IOPs.

Power loading and initial inrush

Other considerations are the nonlinear loading and initial inrush that the Power System subassembly applies to the ac source when power is applied.

Fuse clearing

Clearing of the fuse (3 A) in the High-Performance I/O Link card in the HPMM may require additional current that a single Power Supply cannot adequately provide; therefore, a Power System with redundant Power Supply Modules is recommended.

Power System load requirements

Each Power System's load requirements must be examined as a function of the options that are installed in the High-Performance Process Manager. These demands are discussed in the *TPS System Site Planning* manual.

Power System considerations

Each Power System can provide up to 20 A of 24 Vdc power. By calculating the total current requirement, you can determine how many Power Systems are required. If more than one Power System is required, it may be desirable to connect each High-Performance Process Manager Module (HPMM) to a separate Power System. It may also be desirable to connect the "A" IOP and "B" IOP of a redundant pair to separate Power Systems.

Previously, Figure 2-25 illustrated a typical High-Performance Process Manager subsystem with redundant HPMMs in the same cabinet. Figure 2-26 illustrated a typical large subsystem in a cabinet complex with the redundant HPMMs in separate cabinets. Figure 2-25 illustrated a local cabinet complex with the redundant HPMMs in separate cabinets, and a remote cabinet with IOP card files.

Continued on next page

3.4 Power Draw, Continued

Provide adequate power

Generally, power for a subsystem with redundant HPMMs with up to 35 IOPs can be adequately provided by one Power System. A subsystem with redundant I/O may need additional Power Systems. The power calculation is made using the information provided in this subsection.

Subsystems with either remote I/O, or remote cabinets containing one or more IOP card files must be self-contained with at least one Power System.

3.4.1 Typical 24 Vdc Power Draw Calculations

Overview

Two examples of +24 Vdc power requirement calculations are illustrated in subsections 3.3 and 3.4. The Single Power System Example assumes a single cabinet with a dedicated Power System. The Dual Power System Example assumes a dual cabinet complex with each cabinet having a dedicated separate Power System.

Power calculation procedure

The calculations are based on the power requirements of the assemblies listed in Table 3-1. The current requirements are based on the typical maximum, assuming all channels are in use. Use the following steps to calculate the number of each type of IOP and associated FTA that an individual Power System must support.

1. Determine the number of channels needed for each type of IOP and associated FTA. Divide the total number by the number of channels that are available in the IOP. For example, using Table 3-1, if 256 High Level Analog Input (HLAI) IOP channels are needed, 16 IOPs and FTAs are required ($256 \text{ channels} \div 16 \text{ channels per IOP} = 16 \text{ IOPs and } 16 \text{ FTAs}$).
 2. Multiply the number of IOPs by the current requirement for the type of IOP. For example, 16 model MU-PAIH02 HLA IOPs require 2928 mA ($16 \text{ HLA IOPs} \times 183 \text{ mA} = 2928 \text{ mA or } 2.928 \text{ A}$). The current requirement is added to the **Total Module Current** for the Power System.
 3. Multiply the number of FTAs by the current requirement for the type of FTA. For example, 16 model MU-TAIH12/52 HLA FTAs require 5120 mA ($16 \text{ HLA FTAs} \times 320 \text{ mA} = 5120 \text{ mA or } 5.12 \text{ A}$). The current requirement is added to the **Total Module Current** for the Power System.
 4. If redundant IOPs are required in the same Power System, double the IOP type count. For example, 16 redundant HLA channels, A and B, require two IOPs ($16 \text{ channels} \div 16 \text{ channels per IOP} \times 2 = 2 \text{ IOPs}$). When the redundant IOPs reside in separate Power Systems, half the IOP power requirement is added to each Power System's Module Current power requirement (IOP A and IOP B).
 5. To determine the **Total Module Current**, add together the total current for both the IOPs and their associated FTAs. For example, using Table 3-1, 256 HLA channels require 2928 mA of IOP current and 5120 mA of FTA current ($256 \text{ HLA channels} = 2928 \text{ mA} + 5120 \text{ mA} = 8048 \text{ mA or } 8.048 \text{ A}$).
-

Continued on next page

3.4.1 Typical 24 Vdc Power Draw Calculations, Continued

Assembly 24 Vdc power usage

Table 3-1 is a list of the power usage for High-Performance Process Manager assemblies.

Table 3-1 HPM Assembly 24 Vdc Power Usage

Description	Model Number	Channels	Assembly Current (Milliamps)
Left 7-Slot Card File—Slots 1-7, non-CE Compliant	MU-HPFH01	N/A	0
Left 7-Slot HPMM Card File—Slots 1-7, CE Compliant	MU-HPFH03	N/A	0
Right 7-Slot Card File—Slots 9-15, non-CE Compliant	MU-HPFH11	N/A	0
Right 7-Slot HPMM Card File—Slots 9-15, CE Compliant	MU-HPFH13	N/A	0
15-Slot Card File—Slots 1-15, non-CE Compliant	MU-HPFX02	N/A	0
15-Slot HPMM Card File—Slots 1-15, CE Compliant	MU-HPFX03	N/A	0
Left 7-Slot IOP Card File—Slots 1-7, CE Compliant	MU-HPFI03	N/A	0
Right 7-Slot IOP Card File—Slots 9-15, CE Compliant	MU-HPFI13	N/A	0
15-Slot IOP Card File—Slots 1-15, CE Compliant	MU-HPFI23	N/A	0
IOP Card File	MU-IOFX02	N/A	0
Nonredundant HPMM Card Set	MU-HPMS01	N/A	1375
Redundant HPMM Card Set	MU-HPMR01	N/A	2700
LLAI IOP Card	MU-PAIL02	8	58
LLMux IOP Card	MU-PLAM02	16	70
RHMUX IOP Card (requires an IS or NI Power Adapter)	MU-PRHM01	32	100
HLAI IOP Card	MU-PAIH02	16	183
HLAI IOP Card	MU-PAIH03	16	155
STI IOP Card	MU-PSTX02	16	100
STIM IOP Card	MU-PSTX03	16	100
AO IOP Card	MU-PAOX02	8	100
AO IOP Card	MU-PAOX03	8	100
AO IOP Card	MU-PAOY22	16	112
DI IOP Card	MU-PDIX02	32	90
DI IOP Card	MU-PDIY22	32	89
DISOE IOP Card	MU-PDIS11	32	210
DISOE IOP Card	MU-PDIS12	32	210
DO IOP Card	MU-PDOX02	16	64
DO IOP Card	MU-PDOY22	32	98

Continued on next page

3.4.1 Typical 24 Vdc Power Draw Calculations, Continued

Assembly 24 Vdc power usage, continued

Table 3-1 HPM Assembly 24 Vdc Power Usage, Continued

Description	Model Number	Channels	Assembly Current (Milliamps)
PI IOP Card	MU-PPIX02	8	208
SDI IOP Card	MU-PSDX02	2	70
SI IOP Card	MU-PSIM11	2	70
LLAI FTA	MU-TAIL02	8	350
LLAI FTA	MU-TAIL03	8	350
LLMux—RTD FTA	MU-TAMR02	16	185
LLMux—RTD FTA	MU-TAMR03	16	185
LLMux—TC/Local CJR FTA	MU-TAMT02	16	185
LLMux—TC/Local CJR FTA	MU-TAMT03	16	185
LLMux—TC/Remote CJR FTA	MU-TAMT12	16	185
LLMux—TC/Remote CJR FTA	MU-TAMT13	16	185
RHMUX—TC/Local CJR FTA (ISPA or NIPA provides power to FTA)	MC-GRMT01	16	0
RHMUX GI/IS Power Adapter (ISPA)	MU-GRPA01	32 *	300
RHMUX GI/NI Power Adapter (NIPA)	MU-TRPA01	32 *	575
HLAI/STI FTA	MU-TAIH02	16	320
HLAI FTA	MU-TAIH03	16	320
HLAI/STI FTA	MU-TAIH12/52	16	320
HLAI FTA	MU-TAIH13/53	16	320
HLAI/STI FTA	MU-TAIH22/62	16	320
HLAI FTA	MU-TAIH23	16	320
STI FTA	MU-TSTX03	16	320
STI FTA	MU-TSTX13/53	16	320

* An RHMUX Power Adapter provides the interface between one RHMUX IOP and one or two RHMUX FTAs. Each RHMUX FTA has 16 input channels providing a total of 32 inputs for the RHMUX subsystem.

Continued on next page

3.4.1 Typical 24 Vdc Power Draw Calculations, Continued

Assembly 24 Vdc power usage, continued

Table 3-1 HPM Assembly 24 Vdc Power Usage, Continued

Description	Model Number	Channels	Assembly Current (Milliamps)
AO FTA	MU-TAOX02	8	160
AO FTA	MU-TAOX12/52	8	171
AO FTA	MU-TAOY22/52	16	324
AO FTA	MU-TAOY23/53	16	324
24 Vdc DI FTA	MU-TDID12/52	32	408
24 Vdc DI FTA	MU-TDID72	32	410
24 Vdc Power Distribution Assembly	MU-TDPR02	12	200
24 Vdc DI FTA	MU-TDIY22/62	32	196
120 Vdc DI FTA	MU-TDIA12/52	32	192
120 Vdc DI FTA	MU-TDIA72	32	200
240 Vdc DI FTA	MU-TDIA22/62	32	192
24 Vdc Nonisolated DO FTA	MU-TDON12/52	16	0
24 Vdc Isolated DO FTA	MU-TDOY22/62	32	004
3-30 Vdc Solid-State DO FTA	MU-TDOD12/52	16	160
3-30 Vdc Solid-State DO FTA	MU-TDOD13/53	16	160
3-30 Vdc Solid-State DO FTA	MU-TDOD14/54	16	160
31-200 Vdc Solid-State DO FTA	MU-TDOD22/62	16	160
5-200 Vdc Solid-State DO FTA	MU-TDOD23/63	16	160
24-240 Vac Solid-State DO FTA	MU-TDOA12/52	16	160
120/240 Vac Solid-State DO FTA	MU-TDOA13/53	16	160
120 Vac/125 Vdc Relay DO FTA	MU-TDOR12/52	16	470
240 Vac/125 Vac Relay DO FTA	MU-TDOR22/62	16	470
240 Vac/125 Vac Relay DO FTA	MU-TDOY23/63	16	228
PI FTA	MU-TPIX12/52	8	136

Continued on next page

3.4.1 Typical 24 Vdc Power Draw Calculations, Continued

**Assembly 24 Vdc
power usage,
continued**

Table 3-1 HPM Assembly 24 Vdc Power Usage, Continued

Description	Model Number	Channels	Assembly Current (Milliamps)
SDI FTA—Toledo Scale Cell	MU-TSDT02	1	65
SDI FTA—Manual/Auto Station	MU-TSDM02	1	65
SDI FTA—UDC6000	MU-TSDU02	1	65
Manual/Auto Station	MU-MASX02	N/A	800
SI FTA—Allen-Bradley	MU-TSIA12	1	65
SI FTA—Modbus	MU-TSIM12	1	65
Power Adapter (LLMux, SDI, SI FTAs)	MU-TLPA02	2	360
Galvanically Isolated HLAI FTA	MU-GAIH12/82	16	1200
Galvanically Isolated HLAI/STI FTA	MU-GAIH13/83	16	1200
Galvanically Isolated HLAI/STI FTA	MU-GAIH14/84	16	1200
Galvanically Isolated HLAI FTA	MU-GAIH22/92	16	1200
Galvanically Isolated AO FTA	MU-GAOX02/72	8	440
Galvanically Isolated AO FTA	MU-GAOX12/82	8	440
Galvanically Isolated 24 Vdc DI FTA	MU-GDID12/82	32	800
Galvanically Isolated 24 Vdc DI FTA	MU-GDID13/83	32	800
Galvanically Isolated 24 Vdc DO FTA	MU-GDOD12/82	16	1800
Galvanically Isolated 24 Vdc DO FTA	MU-GDOL12/82	16	1800
Combiner Panel	MU-GLFD02	N/A	0
Marshalling Panel	MU-GMAR02	N/A	0
Galvanic Isolation Power Distribution Assembly	MU-GPRD02	N/A	160
Long Distance I/O Link Extender Cards/Couplers	MU-ILDY02	N/A	300
Long Distance I/O Link Extender Cards/Couplers	MU-ILDY03	N/A	300
Standard I/O Link Extender Cards/Couplers	MU-IOLM02	N/A	196
Standard I/O Link Extender Cards/Couplers	MU-IOLX02	N/A	190
Analog Output Standby Manual with case	MU-SMAC02	4	250
Analog Output Standby Manual - Digital	51401926-100	8	2200
Digital Output Standby Manual with case	MU-SMDC02	16	70
Digital Output Standby Manual without case	MU-SMDX02	16	100

3.4.2 Single Power System Calculation Example

Power calculation example

The following example in Table 3-2 meets the requirement that the total calculated current for an individual Power System be less than, or equal to 20 amperes.

Table 3-2 Single Power System Calculation Example

Assemblies	Total IOP/Module Current	Total FTA Current
Redundant HPMMs	2.700 A	N/A
High Level Analog Input (HLAI) IOPs, nonredundant (256 channels ÷ 16 channels/IOP = 16 IOPs x 183 mA = 2928 mA) (16 FTAs x 320 mA = 5120 mA)	2.928 A	5.120 A
High Level Analog Input (HLAI) IOPs, redundant A & B (16 channels x 2 = 32 channels ÷ 16 channels/IOP = 2 IOPs x 183 mA = 366 mA) (1 FTA x 320 mA = 320 mA)	0.366 A	0.320 A
Analog Output (AO) IOPs, nonredundant (120 channels ÷ 8 channels/IOP = 15 IOPs x 100 mA = 1500 mA) (8 FTAs x 171 mA = 1368 mA)	1.500 A	1.368 A
Analog Output (AO) IOPs, redundant A & B (16 channels x 2 = 32 channels ÷ 8 channels/IOP = 4 IOPs x 100 mA = 400 mA) (2 FTAs x 171 mA = 342 mA)	0.400 A	0.342 A
Subtotals	7.894 A	7.150 A

Total Power System Current = 7.894 + 7.150 = 15.044 A

3.4.3 Dual Power System Calculation Example

Calculation examples The following examples in Table 3-3 and 3-4 meet the requirement that the total calculated current for an individual Power System be less than, or equal to 20 amperes.

Power System 1 calculation

Table 3-3 Dual Power System Calculation Example (Power System 1)

Power System 1		
Assemblies	Total IOP/Module Current	Total FTA Current
Single HPMM	1.375 A	N/A
High Level Analog Input (HLAI) IOPs, nonredundant (80 channels ÷ 16 channels/IOP = 5 IOPs x 183 mA = 915 mA) (16 FTAs x 320 mA = 5120 mA)	0.915 A	1.600 A
High Level Analog Input (HLAI) IOPs, redundant A (240 channels ÷ 16 channels/IOP = 15 IOPs x 183 mA = 2740 mA) (15 FTA x 320 mA = 4800 mA)	2.740 A	4.800 A
Analog Output (AO) IOPs, nonredundant (40 channels ÷ 8 channels/IOP = 5 IOPs x 100 mA = 500 mA) (5 FTAs x 171 mA = 855 mA)	0.500 A	0.855 A
Analog Output (AO) IOPs, redundant A (120 channels ÷ 8 channels/IOP = 15 IOPs x 100 mA = 1500 mA) (15 FTAs x 171 mA = 2565 mA)	1.500 A	2.565 A
Subtotals	7.030 A	9.820 A

Total Power System 1 Current = 7.03 + 9.82 = 16.85 A

Continued on next page

3.4.3 Dual Power System Calculation Example, Continued

Power System 2 calculation

Table 3-4 Dual Power System Calculation Example (Power System 2)

Power System 2		
Assemblies	Total IOP/Module Current	Total FTA Current
Single HPMM	1.375 A	N/A
High Level Analog Input (HLAI IOPs, redundant B (240 channels = 16 channels/IOP = 15 IOPs x 183 mA = 2740 mA) (15 FTAs x 320 mA = 4800 mA)	2.740 A	4.800 A
Analog Output (AO) IOPs, redundant B (120 channels ÷ 8 channels/IOP = 15 IOPs x 100 mA = 1500 mA) (15 FTAs x 171 mA = 2565 mA)	1.500 A	2.565 A
Subtotals	6.615 A	7.365 A

Total Power System 2 Current = 6.615 + 7.365 = 13.98 A

3.4.4 HPM AC Power Draw

Introduction

After you have determined the number of Power Systems that will be required, the subsystem's ac power, substation sizing requirement, and heat generation can be determined.

Maximum power requirements

Provide enough power for fully loaded HPM Power Systems rather than designing only for the existing dc power loads. A Power System with redundant Power Supply Modules that is providing 20 amperes of 24 Vdc power and is charging its 48 vdc backup battery has an ac line draw of 7.6 amperes rms at 120 Vac.

A Power System with a single Power Supply Module that has a 20 ampere 24 Vdc load has an ac line draw of 7.1 amperes rms at 120 Vac.

When operating at 240 Vac, halve the ac current requirement.

3.4.5 Crest Factor

Introduction

Power Systems that were manufactured before November 1994 used a Power Supply Module that is black-colored and was manufactured by the Cherokee Company. The Power Supply Module has a higher crest factor than the Power Supply Module that is currently used in the Power System. The current Power Supply Module is silver-colored and manufactured by Bikor Corporation.

Early production Power Supply Module

The crest factor for the black-colored Cherokee Power Supply Module is 2.2. This means that the current draw from the ac power line is not sinusoidal but has a peak value of 2.2 times the rms current value.

A linear load has a peak current value of 1.414 times the rms value; therefore, the peak value of the current draw from the ac line for this type of Power Supply Module is 1.6 times higher than it would be if the Power Supply Module is a perfectly linear load.

Later production Power Supply Module

The crest factor for the silver-colored Bikor Power Supply Module is 1.7 (worst case). The peak current drawn from the ac power line is 1.7 times the rms current value. The peak value of the current draw from the ac line for the Power Supply Module is 1.2 times higher than it would be if the Power Supply Module is a perfectly linear load.

AC power source sizing

Size the ac substation transformer and/or the UPS to accommodate peak current rather than rms current. This will prevent a distortion problem in the line voltage that is caused by current spikes in the load. Circuit breakers and conductors are still sized by using rms values.

The substation transformer and/or UPS may be providing power to different loads at the facility that have different crest factors. To properly size the substation transformer and/or UPS, you must calculate a crest factor for the aggregate load. To do this, calculate the total peak current and the total rms current for all the loads. The aggregate load crest factor is the ratio of these two values.

3.4.6 Inrush Current

Introduction

This discussion assumes that the Power Supply Module is operating from a 120 Vac line source.

Power systems that were manufactured before November 1994 used a Power Supply Module that was black-colored and was manufactured by the Cherokee Company. The Power Supply Module has a higher inrush current than the Power Supply Module that is currently used in the Power System. The current Power Supply Module is silver-colored and manufactured by Bikor Corporation.

Early production Power Supply Module

When power is initially applied, the black-colored Cherokee Power Supply Module has a worst case instantaneous peak inrush of 85 amperes that declines to 27 amperes peak within two milliseconds. Within five seconds, it then declines to the normal operating repetitive peak current.

For 240 volt operation, the inrush current is doubled.

Two Power Supply Modules on the same circuit breaker will draw twice as much current.

Later production Power Supply Module

The silver-colored Bikor Power Supply Module has an inrush current of 35 amperes for the first half-cycle. After initially applying power to the Power Supply Module, the current diminishes during each half-cycle until the steady-state current is reached within five ac line cycles.

Two Power Supply Modules on the same circuit breaker will draw twice as much current.

Continued on next page

3.4.6 Inrush Current, Continued

Solving the Inrush problem

A substation or UPS can handle the Inrush current by using one of several methods:

- When powering up a large system with many devices, the surge is large and the ac source may take 10 cycles or more to reach specifications; however, because the system is not operational, a slow power-up is not important.
- A substation transformer or a UPS may already include an inherent surge allowance, such as a 50% overload capability while meeting all other specification requirements.
- A larger substation may be purposely selected to include the Inrush as steady state current. For example, applying power to a redundant HPM Power System creates an Inrush of 54 amperes peak. Because the redundant Power Supply Modules already requires a steady state operating current of 8.6 amperes ac rms with a Crest Factor of 2.09, the substation already provides $(8.6 \times 2.09 =)$ 18 amperes peak. Therefore, the example substation needs to be increased in size by $(54 - 18 =)$ 36 amperes peak to handle the surge to service the particular HPM Power System.
- When the UPS is too small to provide a workable Inrush capability, it can be split into even smaller units so that each HPM has its own unit. As such, servicing an HPM may cause a momentary fold-back of its UPS, but the other units are unaffected.

The following discussion on substation sizing considers all the previous current requirements and allows an extra 36 amperes peak for Inrush to service one redundant HPM Power Supply Module at a time. The discussion also assumes that the current production silver-colored Bikor Power Supply Module is in use.

3.5 Substation Sizing

Conversion example

The published current rating for a substation transformer or UPS is created with the assumption that it will be used for a linear load. A linear load has a Crest Factor of $\sqrt{2}$. Because the load Crest Factor for electronic equipment is not $\sqrt{2}$, conversion is required. This is accomplished by converting all the TPS system rms amperages to peak values as illustrated in the following example.

Load Description	RMS Draw (Amperes)	Crest Factor	Peak Draw (Amperes)
HPMMs (5)	38.0	1.7	$38 \times 1.7 = 64.6$
Operator Console CRTs	<u>35.0</u>	2.27	$35 \times 2.27 = \underline{79.5}$
Subtotals	73.0		144.1
Future Expansion	x 1.33		x 1.33
HPM Inrush Allowance			36.0
Total	97.0		228.0

No Inrush allowance for the LCN Operator Console is required. The soft-start power supplies have a maximum Inrush of 10 amperes, so they are easily accommodated by the 36 ampere allowance for the HPMMs.

The 228 ampere peak is derated by $\sqrt{2}$ for the purpose of selecting a transformer; thus, a 161 ampere ($228 \text{ amperes peak} \div \sqrt{2}$) linear-load handling capacity transformer is required. In other words, it is now known that a 161 linear-ampere ac rms transformer can deliver the required 228 ampere peaks.

You will need a 20 kVA (120 V x 161 A) transformer, either for 120 V, 240 V, or 208 V line-to-line grounded Y. Conductors and breakers are sized using the 97 amperes rms calculation.

Substation and UPS requirements

As previously calculated, an off-the-shelf substation or UPS must have a Volt-Amperes (VA) capacity that is significantly greater than the rms total for the load. A custom designed substation or UPS can be designed so that the peak and RMS requirements for electronic loads coincide. Significant economies are possible. See subsection 3.7.

3.6 Circuit Breaker Sizing

AC feeder

For an HPM with one 24 Vdc Power Supply Module, one ac feeder is used. With two Power Supply Modules, one or two feeders may be used. See Figure 3-1 or 3-2.

Circuit breakers

The ac feeder conductors require current limiting for protection. Circuit breakers used for this purpose are to be sized for the ac rms current and are not to be adjusted for the Crest Factor.

One Power Supply Module

An HPM with one 24 Vdc Power Supply Module requires one ac feeder and has a worst case ac line draw of 7.1 amperes ac rms. Local electrical codes usually require that the feeder circuit breaker be sized at 125% of its noncontinuous-plus-continuous load. The ac feeder requires a 10-ampere circuit breaker. This is the nearest common size that gives a 125% over sizing allowance.

Two Power Supply Modules

For an HPM with two 24 Vdc Power Supply Modules on one ac feeder, the total worst case draw is 7.6 amperes ac rms. Again, a 10-ampere circuit breaker is required.

Two Power Supply Modules on two ac feeders

For an HPM with two Power Supply Modules on two ac feeders, either Power Supply Module can draw 7.6 amperes ac rms, or there can be some random proportioning. As such, each feeder needs a 10-ampere circuit breaker. When using two Power Systems for one HPM, two ac feeders are required. Both Power Systems should be connected to both ac feeders.

ATTENTION

ATTENTION—Do not use a circuit breaker larger than 15 amperes. The Power System wiring is not rated to handle a larger feeder.

3.7 Custom UPS and Power Factor

Introduction

Frequently, the UPS and substation components are designed specifically for each installation. Significant economies are possible by specifying the load as thoroughly as possible. The designers will then optimize the design for the exact combination of ac rms current, repetitive peak current, Inrush, and distortion.

Power Supply Module power factor

Power systems that were manufactured before November 1994 used a Power Supply Module that was black-colored and was manufactured by the Cherokee Company. The current Power Supply Module is silver-colored and manufactured by Bikor Corporation. The black-colored Cherokee Power Supply Module has a power factor of 0.8 over a broad range of loads. The current silver-colored Bikor Power Supply Module has a power factor-correction feature incorporated into the design. Its power factor is greater than 0.95.

3.8 Automatic Bypass Switch

Introduction

An automatic bypass switch is often included in the power source to allow instantaneous transfer between two ac sources. Both the primary and backup power sources should be of instrument grade. Transfer to a substandard power source in an emergency does not always happen.

Transfer time requirement

The switch transfer time should be less than 10 milliseconds in both directions. This allows maintenance personnel to freely operate the switch without disturbing the operation. Additional discussion about transfer switches can be found in subsection 3.2.

3.9 Surge Protection

Introduction

Any instrument power distribution panel should have some transient protection. See Figure 3-1 or 3-2.

Protector usefulness

A protector is useful under the following conditions:

- Should an ac feeder develop a short circuit, its circuit breaker may not open until peak currents have reached 10,000 amperes or more. The sudden interruption of such a large current when a circuit breaker opens injects a severe transient into the rest of the electrical system.
 - HPM servicing may require that the Power Supply Modules be turned off and on. Even at normal load currents, significant transients may be generated in the distribution panel.
 - Lightning may strike the facility power feeder and send significant transients into the instrument system.
-

Power Supply Module performance

The HPM Power Supply Module is rated to perform to all its specifications while handling a variety of transients, such as a 3 kV impulse for 8 x 20 microseconds. This provides a safety factor to allow for feed through when the surge protector operates.

MOV protector

A Metallic Oxide Varistor (MOV) is the preferred power line protector. Compared to a protector based on a spark gap, the MOV protector does not short circuit the power along with the transient. Use a 150 kA unit. Overcapacity here does not carry a penalty.

A suitable protector can be purchased from Lightning Protection Corporation in Santa Barbara, CA at telephone number 805-967-5089. For a 120/240 Vac system, use Model 20208.

3.10 Grounded Conductor

Power source's grounded conductor

The power source to the HPM may or may not have a grounded conductor. This does not make any difference to the HPM as long as local electrical codes are satisfied.

3.11 Redundant Safety Grounds

Introduction

The electronics in the HPM are insulated from its enclosures. The use of metal conduits to the enclosures does not affect operation of the equipment. The placement of cabinets on metal floors, the bonding of the cabinets to metal floor supports, cabinets touching metal structure, or the purposeful installation of redundant safety grounds also does not effect the operation of the equipment.

Reference

Grounding is discussed in the *TPS System Site Planning* manual. Grounding also relates to lightning protection that is also discussed in the *TPS System Site Planning* manual.

3.12 Emergency Shutdown

Introduction

Electrical codes may require the ability to shut down system power from principal exit doors. This emergency shutdown requirement is satisfied most economically by placing the instrument power distribution panel within arm's length of the room exit. See the room layout in Figure 2-1.

3.13 Trays and Conduits

Raised floor

Power and signal wiring in the electronics room is easily accommodated by using a raised floor. The space underneath the floor becomes one large wiring tray. Power and signal cables for the HPM may be routed together as long as the cabling is approved for the circuits being handled. Contact or relay signals must be in shielded cables to prevent contact arcing from inducing Electromagnetic Interference (EMI) into other signal cables.

Continued on next page

3.13 Trays and Conduits, Continued

FTA cables

The 50-conductor FTA cables may exit the HPM cabinets and go to facility terminal panels that incorporate FTAs. This is discussed in detail in the *High-Performance Process Manager Installation* manual. The cables have 24 volts from a Class 1 Power Limited source as defined in the National Electrical Code (NEC) in the USA. This usually requires that the FTA cables are installed in their own trays (the connectors are too big to pull through conduit) if they leave the cabinet. The dedicated trays are considered as an extension of the HPM cabinet.

Field circuit

Field circuits are different. Most are limited in the FTAs to Class 2 Power Limited source requirements. This allows a great deal of freedom in their installation as discussed in the Section 5 of this manual.

Cable segregation

Refer to Figure 2-1 for the following discussion. Local codes may require that all wiring be placed in enclosed metal trays or conduit. It is then recommended that the circuits to an HPM be segregated into separate trays or compartment as follows:

- Power cables should be placed in one tray/conduit. The need for a cover depends on local codes. All safety ground conductors also use this tray. The ac circuit cables in this tray usually originate at the instrument ac distribution panel.
 - Process signals at 30 volts ac/dc peak or less go into their own tray/conduit. This includes 1-5 V/4-20 mA, alarm contacts, UCN coaxial cables, and Master Reference Ground (MRG) cables. All signals in the tray usually originate at the 0-30 volt signal terminal panel.
 - Signals above 30 volts, although normally considered as power circuits, should route through their own tray/conduit. All signals in this tray usually originate at the facility 31-250 volt signal terminal panel.
 - FTA cables leaving cabinets usually need their own tray as discussed previously.
-

Intrinsic Safety

Intrinsic Safety systems with zener barriers or current limiting resistors usually require another conduit or tray compartment. This is covered in Section 5 of this manual.

3.14 Existing TPS System AC Power

Power compatibility

The power required for the HPM is compatible with power provided for all other TPS systems. Connect the HPM to existing TPS system's power when it is convenient.

Section 4 – Process Wiring

4.1 Overview

Section contents The topics covered in this section are:

	Topic	See Page
4.1	Overview.....	71
4.2	FTA Selection	72
4.3	Cabinet Entry	79
4.4	Signal Tray Wiring Compatibility.....	80
4.5	Process Wiring Termination.....	81

Introduction

The process control signal wires connect to the High-Performance Process Manager (HPM) at the Field Termination Assemblies (FTAs). The type of FTA selected is dependent upon the process equipment. There are 16 types of FTAs to choose from. Some of the FTA types support IOP redundancy. Some FTA types provide Galvanic Isolation and are for Intrinsically Safe applications.

ATTENTION

ATTENTION—In the past, it was a requirement that Galvanically Isolated, Intrinsically Safe (GI/IS) FTAs had to be mounted on horizontally oriented FTA Mounting Channels in an HPM cabinet. The requirement is no longer needed because of component and design improvements.

Galvanically Isolated FTAs can now be mounted on vertically oriented FTA Mounting Channels; however, there is still a requirement that Galvanically Isolated FTAs and standard (non-Galvanically Isolated) FTAs, and the wiring to them, be properly separated in the cabinet.

Any FTA Mounting Channels on which Galvanically Isolated FTAs will be mounted must be installed in an inverted (upside down from the normal) position.

FTA mounting

FTAs are installed on FTA Mounting Channels that are located in the front of a single-access HPM cabinet, and in the rear and/or front of a dual-access cabinet. The number of FTA Mounting Channels that can be accommodated in a cabinet is dependent upon whether the cabinet is single access or dual access, and whether standard or wide FTA Mounting Channels are installed. See Section 8 or 9 for a detailed description of the cabinets and their FTA Mounting Channels.

Continued on next page

4.1 Overview, Continued

ATTENTION

The field wiring to Galvanically Isolated FTAs must be routed such that a strict 2-inch minimum separation is maintained between any other wiring, cable, or electrical part, or be separated by a divider that is grounded metal or nonconductive material.

FTA Mounting Channels

FTA Mounting Channels are available in two sizes, standard and wide, to better accommodate the amount of process control wiring that connects to the FTAs. The FTA Mounting Channels provide both a mounting surface for the FTAs and dual channels (troughs) to route the FTA to IOP cabling, and the process control wiring.

The standard (non-Galvanically Isolated) FTA to IOP or Power Distribution Assembly cabling is routed in the right channel, and the process control wiring is routed in the left channel. The reverse is true for Galvanically Isolated FTAs because the FTA Mounting Channel is installed in an inverted position.

Power Distribution and Marshalling Panels

The model MU/MC-GPRD02 Power Distribution Panel can be mounted on any FTA Mounting Channel that is installed in the normal or inverted position; however, proper wiring separation must be observed.

The model MU/MC-GMAR52 Marshalling Panel must not be mounted on an FTA Mounting Channel that has a Galvanically Isolated FTA mounted on it.

4.2 FTA Selection

Overview

The FTA has circuits that convert the process control signals to voltage and current levels that can be accommodated by the High-Performance Process Manager electronics. There are a number of FTA types with each type designed for a specific type of signal.

Rules

Rules for selecting the appropriate FTAs, installing, configuring, and the connections to the associated IOP and the process control signals, are discussed in detail in the *Process Manager I/O Installation* manual.

Continued on next page

4.2 FTA Selection, Continued

FTA sizes

The assembly layouts of three physical sizes of FTAs are illustrated in Figure 4-1.

Figure 4-1 Field Termination Assembly (FTA) Sizes

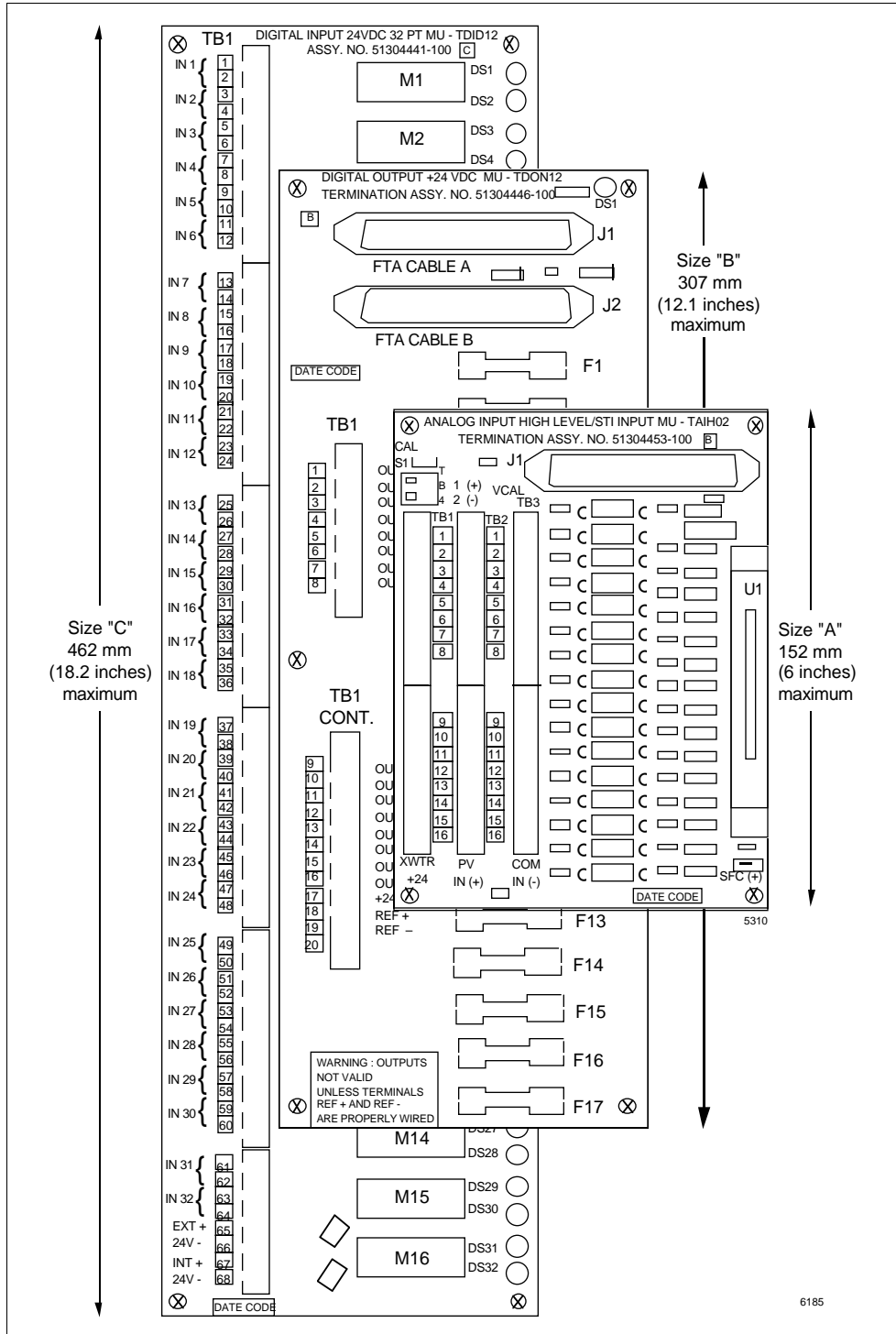

Continued on next page

4.2 FTA Selection, Continued

FTA sizes, continued

As a function of the type and number of process control signals the FTA interfaces, FTAs are produced in three different sizes, size A, B, and C. The size dimensions are shown in Figure 4-2.

Figure 4-2 Field Termination Assembly (FTA) Mounting Dimensions

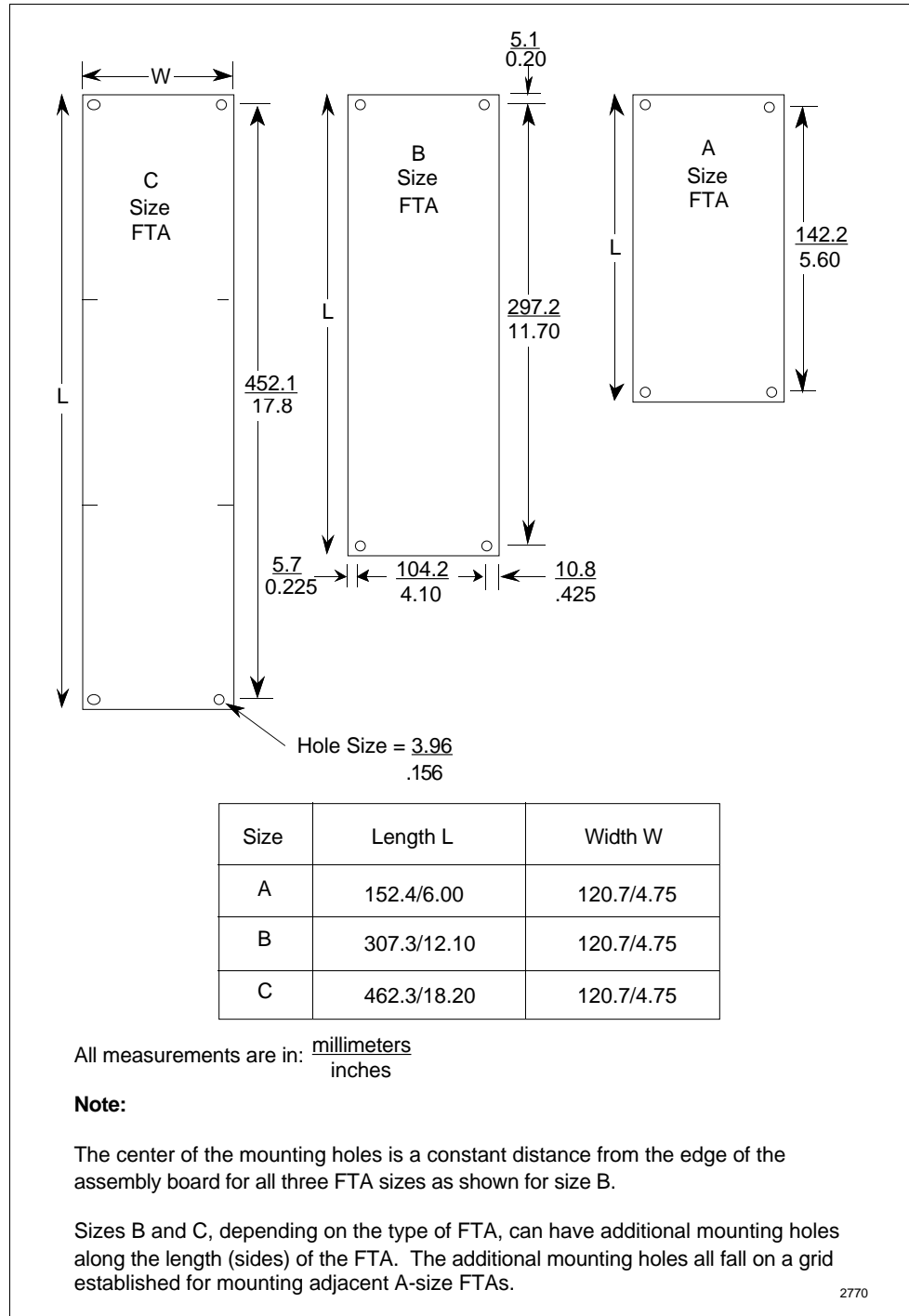

Continued on next page

4.2 FTA Selection, Continued

FTA types

Because of FTA size differences, the number of FTAs that can be installed in a cabinet will vary. Tables 4-1 and 4-2 are lists of FTAs and support assemblies by model number. When appropriate, the FTA's or supporting assembly's field terminal connector type, number of input or output signal channels, and mounting size are listed.

Standard FTAs

For standard types of FTAs, the terminal connector types are compression (C), nonremovable screw (S), and removable screw (RS).

Table 4-1 Standard FTAs and Associated Assemblies

Model Number	Description	Terminal Type	Channels	Mounting Size
MU-TAIH02	High Level Analog Input/STI (Single IOP)	C	16	A
MU-TAIH03	High Level Analog Input (Single IOP)	C	16	A
MU-TAIH12	High Level Analog Input/STI	C	16	B
MU-TAIH13	High Level Analog Input	C	16	B
MU-TAIH22	Enhanced Power High Level Analog Input/STI	C	16	B
MU-TAIH23	Enhanced Power High Level Analog Input	C	16	B
MU-TAIH52	High Level Analog Input/STI	S	16	B
MU-TAIH53	High Level Analog Input	S	16	B
MU-TAIH62	Enhanced Power High Level Analog Input/STI	S	16	B
MU-TSTX03	Smart Transmitter Interface (Single IOP)	C	16	A
MU-TSTX13	Smart Transmitter Interface	C	16	B
MU-TSTX53	Smart Transmitter Interface	S	16	B
MU-TAIL02	Low Level Analog Input (Single IOP)	C	8	B
MU-TAIL03	Low Level Analog Input (Single IOP)	C	8	B
MU-TAMR02	Low Level Analog Input Multiplexer—RTD (Single IOP)	C	16	B
MU-TAMR03	Low Level Analog Input Multiplexer—RTD (Single IOP)	C	16	B
MU-TAMT02	Low Level Analog Input Multiplexer—TC—Local CJR (Single IOP)	C	16	B
MU-TAMT03	Low Level Analog Input Multiplexer—TC—Local CJR (Single IOP)	C	16	B
MU-TAMT12	Low Level Analog Input Multiplexer—TC—Remote CJR (Single IOP)	C	16	B
MU-TAMT13	Low Level Analog Input Multiplexer—TC—Remote CJR (Single IOP)	C	16	B

Continued on next page

4.2 FTA Selection, Continued

Standard FTAs, continued

Table 4-1 Standard FTAs and Associated Assemblies, Continued

Model Number	Description	Terminal Type	Channels	Mounting Size
MC-GRMT01	Remote Hardened Low Level Analog Input Multiplexer TC Local CJR	S	16	Non Standard
MU-GRPA01	RHMUX GI/IS Power Adapter	C	2	A
MU-TRPA01	RHMUX GI/NI Power Adapter	C	2	B
MU-TAOX02	Analog Output (Single IOP)	C	8	A
MU-TAOX12	Analog Output	C	8	B
MU-TAOX52	Analog Output	S	8	B
MU-TAOY22	Analog Output with Standby Manual Connector	C	16	B
MU-TAOY23	Analog Output without Standby Manual Connector	C	16	B
MU-TAOY52	Analog Output with Standby Manual Connector	S	16	B
MU-TAOY53	Analog Output without Standby Manual Connector	S	16	B
MU-TDID12	24 Vdc Digital Input	C	32	C
MU-TDID52	24 Vdc Digital Input	S	32	C
MU-TDID72	24 Vdc Digital Input (Single IOP)	RS	32	C
MU-TDIY22	24 Vdc Digital Input	C	32	B
MU-TDIY62	24 Vdc Digital Input	S	32	B
MU-TDIA12	120 Vdc Digital Input	C	32	C
MU-TDIA52	120 Vdc Digital Input	S	32	C
MU-TDIA72	120 Vdc Digital Input (Single IOP)	RS	32	C
MU-TDIA22	240 Vdc Digital Input	C	32	C
MU-TDIA62	240 Vdc Digital Input	S	32	C
MU-TDON12	24 Vdc Nonisolated Digital Output	C	16	B
MU-TDON52	24 Vdc Nonisolated Digital Output	S	16	B
MU-TDOY22	24 Vdc Isolated Digital Output	C	32	B
MU-TDOY62	24 Vdc Isolated Digital Output	S	32	B

Continued on next page

4.2 FTA Selection, Continued

Standard FTAs,
continued

Table 4-1 Standard FTAs and Associated Assemblies, Continued

Model Number	Description	Terminal Type	Channels	Mounting Size
MU-TDOD12	3-30 Vdc Solid-State Digital Output	C	16	B
MU-TDOD13	3-30 Vdc Solid-State Digital Output	C	16	B
MU-TDOD14	3-30 Vdc Solid-State Digital Output	C	16	B
MU-TDOD52	3-30 Vdc Solid-State Digital Output	S	16	B
MU-TDOD53	3-30 Vdc Solid-State Digital Output	S	16	B
MU-TDOD54	3-30 Vdc Solid-State Digital Output	S	16	B
MU-TDOD22	31-200 Vdc Solid-State Digital Output	C	16	B
MU-TDOD23	31-200 Vdc Solid-State Digital Output	C	16	B
MU-TDOD62	31-200 Vdc Solid-State Digital Output	S	16	B
MU-TDOD63	31-200 Vdc Solid-State Digital Output	S	16	B
MU-TDOA12	120/240 Vac Solid-State Digital Output	C	16	B
MU-TDOA13	120/240 Vac Solid-State Digital Output	C	16	B
MU-TDOA52	120/240 Vac Solid-State Digital Output	S	16	B
MU-TDOA53	120/240 Vac Solid-State Digital Output	S	16	B
MU-TDOR12	120 Vac/125 Vdc Relay Digital Output	C	16	B
MU-TDOR52	120 Vac/125 Vdc Relay Digital Output	S	16	B
MU-TDOY23	120 Vac/125 Vdc Relay Digital Output	C	16	B
MU-TDOY63	120 Vac/125 Vdc Relay Digital Output	S	16	B
MU-TDOR22	240 Vac/125 Vdc Relay Digital Output	C	16	B
MU-TDOR62	240 Vac/125 Vdc Relay Digital Output	S	16	B
MU-TPIX12	Pulse Input	C	8	B
MU-TPIX52	Pulse Input	S	8	B
MU-TSDT02	Serial Device Interface—Toledo Weigh Cell	DB-25	1	A
MU-TSDM02	Serial Device Interface—Manual/Auto Station	C	1	A
MU-TSDU02	Serial Device Interface—UDC 6000 Modbus	C	1	A
MU-TSIA12	Serial Interface—Allen-Bradley	DB-25	1	A

Continued on next page

4.2 FTA Selection, Continued

Standard FTAs, continued

Table 4-1 Standard FTAs and Associated Assemblies, Continued

Model Number	Description	Terminal Type	Channels	Mounting Size
MU-TSIM12	Serial Interface—Modbus RTU	C/DB-25	1	A
MU-TDPR01	Digital Input Power Distribution Assembly—16 outputs	S	N/A	A
MU-TDPR02	Digital Input Power Distribution Assembly—12 outputs	S	N/A	A
MU-TLPA02	Power Adapter (supports LLMux, SDI, and SI)	C	2	A

Galvanically Isolated FTAs

For Galvanically Isolated FTAs, the terminal connector types are compression (C) and crimp pin (CP). The Marshalling Panel has nonremovable screw (S) terminals.

Table 4-2 Galvanically Isolated FTAs and Associated Assemblies

Model Number	Description	Terminal Type	Channels	Mounting Size
MC-GRMT01	Remote Hardened Low Level Analog Input Multiplexer TC with Local CJR	S	16	Non Standard
MU-TRPA01 *	Remote Hardened Non-Incendive Power Adapter	C	2	B
MU-GRPA01 *	Remote Intrinsically Safe Power Adapter	C	2	A
MU-GAIH12	High Level Analog Input	C	16	B
MU-GAIH82	High Level Analog Input	CP	16	B
MU-GAIH13	High Level Analog Input/Smart Transmitter Interface	C	16	B
MU-GAIH83	High Level Analog Input/Smart Transmitter Interface	CP	16	B
MU-GAIH14	High Level Analog Input/Smart Transmitter Interface (High drive)	C	16	B
MU-GAIH84	High Level Analog Input/Smart Transmitter Interface (High drive)	CP	16	B
MU-GAIH22	High Level Analog Input (Auxiliary receiver output)	C	16	B
MU-GAIH92	High Level Analog Input (Auxiliary receiver output)	CP	16	B

* The RHMUX Power Adapter receives +24 V power through the cable that interfaces with the RHMUX IOP, not the GI Power Distribution Assembly (MU-GPDR02). The Power Adapter provides the interface between one RHMUX IOP and two RHMUX FTAs.

Continued on next page

4.2 FTA Selection, Continued

Galvanically Isolated FTAs, continued

Table 4-2 Galvanically Isolated FTAs and Associated Assemblies, Continued

Model Number	Description	Terminal Type	Channels	Mounting Size
MU-GAOX02	Analog Output (Single IOP)	C	8	B
MU-GAOX72	Analog Output (Single IOP)	CP	8	B
MU-GAOX12	Analog Output	C	8	B
MU-GAOX82	Analog Output	CP	8	B
MU-GDID12	24 Vdc Digital Input (Contact output to IOP)	C	32	B
MU-GDID82	24 Vdc Digital Input (Contact output to IOP)	CP	32	B
MU-GDID13	24 Vdc Digital Input (Solid-state output to IOP)	C	32	B
MU-GDID83	24 Vdc Digital Input (Solid-state output to IOP)	C	32	B
MU-GDOD12	24 Vdc Digital Output (Contact output to IOP)	C	16	B
MU-GDOD82	24 Vdc Digital Output (Contact output to IOP)	CP	16	B
MU-GDOL12	24 Vdc Digital Input (Line Fault Detection)	C	16	B
MU-GDOL82	24 Vdc Digital Input (Line Fault Detection)	CP	16	B
MU-GLFD02	Combiner Panel	N/A	N/A	A
MU-GPRD02	Power Distribution Assembly	N/A	N/A	A
MU-GMAR52	Marshalling Panel	S	N/A	B

4.3 Cabinet Entry

Cabinet Access

The process control signal cables enter the High-Performance Process Manager cabinet through either the top or bottom.

Bottom entry

For bottom entry, the cabinet floor has sliding plates that are retained by cage nuts or Allen screws. The plates can be adjusted to vary the size of the entry slots.

Top entry

When top entry is desired, the top panel is removed by extracting the cabinet lifting eye-bolts, and then punching entry holes in the panel as needed.

CAUTION

CAUTION—Do not attempt to punch holes in the panel while it is still mounted on the cabinet. This may cause metal debris from the panel to drop down onto the cabinet equipment and result in electrical damage when power is applied to the equipment.

Cable clamping

For either top or bottom entry, the cables should be clamped firmly to the inside of the cabinet. The clamping should be able to withstand approximately a 45 kg (100 pound) pull. The cabinet is special because it includes a cable clamp rail at the bottom. The rail can be remounted at the top if required.

Reference

See Section 8 or 9 for a illustration that shows the floor FTA cable entry points for the type of cabinet installed.

4.4 Signal Tray Wiring Compatibility

Wiring rules

The process wiring to the High-Performance Process Manager should be segregated by signal level in different trays or conduits to minimize cross talk. The segregation rules are as follows:

- Millivolt signals from electrical components, such as thermocouples, low voltage dc signals, 1-5 V/4-20 mA, and digital/contact circuits with voltages less than 30 Vac peak/DC, should be in individual cables that provide a protective shield. They can all be routed in the same cable tray. The tray can also include UCN coaxial cables, Master Reference Ground cables (Safety Ground cables in a CE Compliant installation) cables, and 50-conductor FTA to IOP cables.
- Circuits running at higher voltages, or nonshielded circuits at any voltage, belong in their own metal tray compartment or conduit. Thermocouple signals with a common mode of over 30 Vdc are also in this latter category.
- Wiring to Galvanically Isolated FTA must be separated from all other wiring.

More information can be found in the *High-Performance Process Manager Installation*, *Process Manager I/O Installation*, or the *TPS System Site Planning* manuals.

4.5 Process Wiring Termination

Compression terminals Most of the standard types of FTAs are available with compression-type terminal connectors that mate with the FTA's connectors. To connect to an FTA with compression-type terminal connectors, the wire insulation is striped for 75 millimeters (3/8 inch), plus or minus 3 millimeters (1/8 inch), inserted into the connector terminal, and then held by tightening the individual terminal screw. The connector accepts 0.3 to 2.5 mm² (14 to 22 AWG) stranded wire. It also accepts two 1.0 mm² (18 AWG) stranded wires, or a single 3.5 mm² (12 AWG) solid wire. Figure 2-11 is an illustration of a typical compression-type terminal connector.

Screw terminals Some standard FTAs are available with screw-type terminal connectors that can accept the installation of a wire lug at the end of the wire. Refer to Figure 2-12 for an illustration of a typical fixed-screw type terminal connector and Figure 2-13 for an illustration of a typical removable-screw type terminal connector.

Pluggable connectors The Galvanically Isolated FTAs do not have field terminal connectors mounted directly on the assembly's printed circuit board as the standard FTAs do, but instead field wires are connected to compression-type or crimp pin-type pluggable connectors that mate with the connector on the individual Galvanic Isolation Module. The compression-type connectors accommodate size 0.3 to 3.5 mm² (12 to 22 AWG) wiring, while the crimp-type terminal connectors accommodate size 0.5 to 2.5 mm² (14 to 20 AWG) wiring. Figures 2-14 and 2-15 are illustrations of the crimp pin-type and compression-type pluggable terminal connectors, respectively.

FTA signal requirements The wiring schematics, terminal connections, and other details for wiring each type of FTA are discussed in detail in the *Process Manager I/O Installation* manual. Refer to this manual for special installation requirements for some FTAs, such as the Low Level Analog Input Multiplexer, Serial Device Interface, and Serial Interface FTAs.

Section 5 – Hazardous Environment Planning

5.1 Overview

Section contents The topics covered in this section are:

	Topic	See Page
5.1	Overview.....	83
5.2	Hazardous Area Classifications	84
5.3	Mounting and Operating the HPM in a Division 2 Location	86
5.4	Field Wiring in Hazardous Locations.....	100

Introduction

Certain processes handle ignitable or explosive materials. Local electrical codes require that electrical devices that are located in, or connected to, such process areas have some type of control to prevent accidental ignition of the process material. Terminology used to discuss these installations is defined in this section, followed by specific requirements for the High-Performance Process Manager (HPM). For information about intrinsic safety applications, see your Honeywell Sales Engineer.

5.2 Hazardous Area Classifications

National Electrical Code Hazardous materials are classified by a variety of terms. The terminology for the National Electrical Code (NEC) that is used in the United States is summarized in Table 5-1. The table is not complete. Check your own local electrical codes for additional information and definition.

Table 5-1 Hazardous Area Classifications

NEC	Environment
Class I	Explosive gases or vapors are present.
Class II	Combustible dusts are present.
Class III	Ignitable fibers or flyings are present.
Division 1	A location where a hazardous concentration of gases or vapors exists approximately 10-100% of the time (subject to interpretation as above).
Division 1	A location where a hazardous concentration of gases or vapors exists approximately 1-10% of the time (subject to interpretation as above).
Division 2	A location where a hazardous concentration of gases or vapors exists approximately 0.1-1% of the time (subject to interpretation as above).
Nonhazardous	Hazardous vapors exist less than .1% of the time.
Group A	A hazardous atmosphere containing acetylene or other similar gases or vapors.
Group B	A hazardous atmosphere containing hydrogen or other similar gases or vapors.
Group C	A hazardous atmosphere containing ethylene or other similar gases or vapors.
Group D	A hazardous atmosphere containing pentane or other similar gases or vapors.
Group E	A hazardous atmosphere containing metal dust, such as aluminum.
Group F	A hazardous atmosphere containing carbon black, coal, or coke dust.

Continued on next page

5.2 Hazardous Area Classifications, Continued

Interpretation of Division 2 rules

Electrical equipment can be mounted in an NEC Division 2 location as long as it does not create a fire hazard during normal operation or routine maintenance. In other words, the equipment does not produce electrical sparks or have hot surface temperatures that are sufficient to ignite the hazardous vapors that may be present.

The equipment is allowed to produce sparks or hot surfaces if it malfunctions because there is a low probability that there will be hazardous vapors present at the same time as the malfunction.

The equipment is allowed to produce sparks or hot surfaces during repair or restorative maintenance because the personnel performing the maintenance are expected to be aware of the danger and to detect the presence of hazardous vapors before starting the work.

5.3 Mounting and Operating the HPM in a Division 2 Location

Factory Mutual approval Many of the devices in a High-Performance Process Manager subsystem have been examined and certified by Factory Mutual (FM) as safe for mounting in Class 1, Division 2 locations. Certain other devices such as a Field Termination Assembly (FTA) that contains unsealed relay contacts is not approved for these applications. Table 5-2 is a list of the approved devices. When an HPM cabinet is intended to be mounted in a Division 2 location, it must contain only the approved devices. A label that displays the FM logo is attached to the cabinet.

HPM placement considerations The considerations for High-Performance Process Manager placement are

- Use only those High-Performance Process Manager assemblies that have been certified for safe usage in Division 2 locations, or
- Locate the High-Performance Process Manager in a nonhazardous area, or
- Purge the High-Performance Process Manager enclosure or the High-Performance Process Manager area of gasses or vapors.

HPM placement publications In the USA, the Division 2 or nonhazardous area for placing High-Performance Process Manager enclosures can be selected by using publications such as the National Fire Protection Agency (NFPA) publication #497, *Classification of Class I Hazardous Locations for Electrical Installations in Chemical Plants*. Should no Division 2 or nonhazardous area exist, purged/pressurized enclosures or buildings are needed. Suitable purge techniques are described in local electrical code documents such as the NFPA #496, *Purged and Pressurized Enclosures for Electrical Equipment*.

Continued on next page

5.3 Mounting and Operating the HPM in a Division 2 Location, Continued

Approved Division 2 area equipment

Table 5-2 lists the High-Performance Process Manager equipment that is approved for operation in Division 2 areas.

Table 5-2 HPM Equipment Approved for Use in a Division 2 Area

Model Number	Description
IOPs	
MU-PAIH03	High Level Analog Input (HLAI)
MU-PAIL02	Low level Analog Input (LLAI)
MU-PAOX03	Analog Output (AO)
MU-PAOY22	Analog Output (AO)
MU-PDIS12	Digital Input Sequence of Events (DI)
MU-PDIX02	Digital Input (DI)
MU-PDIY22	Digital Input (DI)
MU-PDOX02	Digital Output (DO)
MU-PDOY22	Digital Output (DO)
MU-PLAM02	Low Level Multiplexer (LLMux)
MU-PRHM01	Remote Hardened Low Level Multiplexer (RHMUX)
MU-PPIX02	Pulse Input (PI)
MU-PSDX02	Serial Device Interface (SDI)
MU-PSIM11	Serial Interface (SI)
MU-PSTX03	Smart Transmitter Interface (STIM)

Continued on next page

5.3 Mounting and Operating the HPM in a Division 2 Location,

Continued

Approved Division 2
area equipment,
continued

Table 5-2 HPM Equipment Approved for Use in Division 2 Areas,
Continued

Model Number	Description
Standard FTA Components	
MU-TAIH02	High Level Analog Input/STI with compression terminals
MU-TAIH03	High Level Analog Input/STI with compression terminals
MU-TAIH12	High Level Analog Input/STI with compression terminals
MU-TAIH13	High Level Analog Input/STI with compression terminals
MU-TAIH22	High Level Analog Input/STI with compression terminals
MU-TAIH23	High Level Analog Input with compression terminals
MU-TAIH52	High Level Analog Input/STI with screw terminals
MU-TAIH53	High Level Analog Input/STI with screw terminals
MU-TAIH62	High Level Analog Input/STI with screw terminals
MU-TAIL02	Low Level Analog Input with compression terminals
MU-TAIL03	Low Level Analog Input with compression terminals
MU-TAMR02	LLMux Analog Input RTD with compression terminals
MU-TAMR03	LLMux Analog Input RTD with compression terminals
MU-TAMT02	LLMux Analog Input TC with compression terminals
MU-TAMT03	LLMux Analog Input TC with compression terminals
MU-TAMT12	LLMux Analog Input TC with remote CJR, compress terminals
MU-TAMT13	LLMux Analog Input TC with remote CJR, compress terminals
MU-TAOX02	Analog Output with compression terminals
MU-TAOX12	Analog Output with compression terminals
MU-TAOX52	Analog Output with screw terminals
MU-TAOY22	Analog Output with compress terminals, with Standby Manual
MU-TAOY23	Analog Output with comp terminals, without Standby Manual
MU-TAOY52	Analog Output with screw terminals, with Standby Manual
MU-TAOY53	Analog Output with screw terminals, without Standby Manual

Continued on next page

5.3 Mounting and Operating the HPM in a Division 2 Location,

Continued

Approved Division 2
area equipment,
continued

Table 5-2 HPM Equipment Approved for Use in Division 2 Areas,
Continued

Model Number	Description
Standard FTA Components, continued	
MU-TDIA12	120 Vac Digital Input with compression terminals
MU-TDIA22	240 Vac Digital Input with compression terminals
MU-TDIA52	120 Vac Digital Input with fixed screw terminals
MU-TDIA62	240 Vac Digital Input with fixed screw terminals
MU-TDID12	24 Vdc Digital Input with compression terminals
MU-TDID52	24 Vdc Digital Input with fixed-screw terminals
MU-TDID72	24 Vdc Digital Input with removable-screw terminals
MU-TDIY22	24 Vdc Digital Input with compression terminals
MU-TDIY62	24 Vdc Digital Input with screw terminals
MU-TDOA12	120/240 Vac Solid-State Digital Output with Comp terminals
MU-TDOA13	120/240 Vac Solid-State Digital Output with Comp terminals
MU-TDOA52	120/240 Vac Solid-State Digital Output with Screw terminals
MU-TDOA53	120/240 Vac Solid-State Digital Output with Screw terminals
MU-TDOD12	3-30 Vdc Digital Output with compression terminals
MU-TDOD13	3-30 Vdc Digital Output with compression terminals
MU-TDOD14	3-30 Vdc Digital Output with compression terminals
MU-TDOD22	31-200 Vdc Digital Output with compression terminals
MU-TDOD23	5-200 Vdc Digital Output with compression terminals
MU-TDOD52	3-30 Vdc Digital Output with screw terminals
MU-TDOD53	3-30 Vdc Digital Output with screw terminals
MU-TDOD54	3-30 Vdc Digital Output with screw terminals
MU-TDOD62	31-200 Vdc Digital Output with fixed-screw terminals
MU-TDOD63	5-200 Vdc Digital Output with screw terminals

Continued on next page

5.3 Mounting and Operating the HPM in a Division 2 Location, Continued

Approved Division 2
area equipment,
continued

Table 5-2 HPM Equipment Approved for Use in Division 2 Areas,
Continued

Model Number	Description
Standard FTA Components, continued	
MU-TDON12	24 Vdc Nonisolated Digital Output with compress terminals
MU-TDON52	24 Vdc Nonisolated Digital Output with screw terminals
MU-TDOY22	24 Vdc Isolated Digital Output with compression terminals
MU-TDOY62	24 Vdc Isolated Digital Output with screw terminals
MU-TDPR02	Digital Input Power Distribution Assembly
MU-TLPA02	Power Adapter (LLMux, SDI, SI)
MU-TPIX12	Pulse Input with compression terminals
MU-TPIX52	Pulse Input with screw terminals
MU-TSDM02	Serial Device Interface—Manual/Auto Station
MU-TSDT02	Serial Device Interface—Toledo Weigh Cell
MU-TSIM12	Serial Interface—Modbus EIA-232
MU-TSTX03	Smart Transmitter Interface with compression term
MU-TSTX13	Smart Transmitter Interface with compression term
MU-TSTX53	Smart Transmitter Interface with screw terminals

Continued on next page

5.3 Mounting and Operating the HPM in a Division 2 Location, Continued

Approved Division 2
area equipment,
continued

Table 5-2 HPM Equipment Approved for Use in Division 2 Areas,
Continued

Model Number	Description
Galvanically Isolated FTA Components	
MC-GRMT01	RHMUX Analog Input TC with screw terminals
MU-GRPA01	RHMUX GI/IS Power Adapter with compression terminals
MU-TRPA01	RHMUX GI/NI Power Adapter with compression terminals
MU-GAIH12	High Level Analog Input with compression terminals
MU-GAIH13	HLAI/STI with compression terminals
MU-GAIH14	HLAI/STI with compression terminals
MU-GAIH22	High Level Analog Input with compression terminals
MU-GAIH82	High Level Analog Input with crimp terminals
MU-GAIH83	HLAI/STI with crimp terminals
MU-GAIH84	HLAI/STI with crimp terminals
MU-GAIH92	High Level Analog Input with crimp terminals
MU-GAOX02	Analog Output with compression terminals
MU-GAOX12	Analog Output with compression terminals
MU-GAOX72	Analog Output with crimp term
MU-GAOX82	Analog Output with crimp terminals
MU-GDID12	Digital Input with compression terminals
MU-GDID13	Digital Input with compression terminals
MU-GDID82	Digital Input with crimp terminals
MU-GDID83	Digital Input with crimp terminals
MU-GDOD12	24 Vdc Digital Output with compression terminals
MU-GDOD82	24 Vdc Digital Output with crimp terminals
MU-GDOL12	24 Vdc Digital Output with compression terminals
MU-GDOL82	24 Vdc Digital Output with crimp terminals

Continued on next page

5.3 Mounting and Operating the HPM in a Division 2 Location, Continued

Approved Division 2
area equipment,
continued

Table 5-2 HPM Equipment Approved for Use in Division 2 Areas,
Continued

Model Number	Description
Galvanically Isolated FTA Components, continued	
MU-GLFD02	Combiner Panel
MU-GMAR52	Marshalling Panel
MU-GPRD02	Power Distribution Assembly
I/O Link Extenders	
MU-IOLM02	Standard I/O Link Extender—Local Card File
MU-IOLX02	Standard I/O Link Extender—Remote Card File
MU-ILDX03	Long Distance I/O Link Extender
HPMM Card Sets	
MU-HPMS01	Nonredundant HPMM Card Set
MU-HPMR01	Redundant HPMM Card Sets
Card File Assemblies	
MU-HPFH01	Left 7-Slot Card File Assembly
MU-HPFH03	Left 7-Slot HPMM Card File Assembly
MU-HPFH11	Right 7-Slot Card File Assembly
MU-HPFH13	Right 7-Slot HPMM Card File Assembly
MU-HPFX02	15-Slot Card File Assembly
MU-HPFX03	15-Slot HPMM Card File Assembly
MU-HPFI03	Left 7-Slot IOP Card File Assembly
MU-HPFI13	Right 7-Slot IOP Card File Assembly
MU-HPFI23	15-Slot IOP Card File Assembly

Continued on next page

5.3 Mounting and Operating the HPM in a Division 2 Location,

Continued

Approved Division 2
area equipment,
continued

Table 5-2 HPM Equipment Approved for Use in Division 2 Areas,
Continued

Model Number	Description
Cables	
MU-KTPC00	FTA to IOP, DIN to DIN connector
MU-KTPC05	FTA to IOP, DIN to DIN connector—5 meters
MU-KTPC10	FTA to IOP, DIN to DIN connector—10 meters
MU-KTPC15	FTA to IOP, DIN to DIN connector—15 meters
MU-KTPC20	FTA to IOP, DIN to DIN connector—20 meters
MU-KTPC25	FTA to IOP, DIN to DIN connector—25 meters
MU-KTPC30	FTA to IOP, DIN to DIN connector—30 meters
MU-KTPC35	FTA to IOP, DIN to DIN connector—35 meters
MU-KTPC40	FTA to IOP, DIN to DIN connector—40 meters
MU-KTPC45	FTA to IOP, DIN to DIN connector—45 meters
MU-KTPC50	FTA to IOP, DIN to DIN connector—50 meters
MU-KFTA00	FTA to IOP, phone to phone connector
MU-KFTA05	FTA to IOP, phone to phone connector—5 meters
MU-KFTA10	FTA to IOP, phone to phone connector—10 meters
MU-KFTA15	FTA to IOP, phone to phone connector—15 meters
MU-KFTA20	FTA to IOP, phone to phone connector—20 meters
MU-KFTA25	FTA to IOP, phone to phone connector—25 meters
MU-KFTA30	FTA to IOP, phone to phone connector—30 meters
MU-KFTA35	FTA to IOP, phone to phone connector—35 meters
MU-KFTA40	FTA to IOP, phone to phone connector—40 meters
MU-KFTA45	FTA to IOP, phone to phone connector—45 meters
MU-KFTA50	FTA to IOP, phone to phone connector—50 meters

Continued on next page

5.3 Mounting and Operating the HPM in a Division 2 Location, Continued

Approved Division 2
area equipment,
continued

Table 5-2 HPM Equipment Approved for Use in Division 2 Areas,
Continued

Model Number	Description
Cables, continued	
MU-KFTS00	FTA to IOP, phone to phone connector
MU-KFTS05	FTA to IOP, phone to phone connector—5 meters
MU-KFTS10	FTA to IOP, phone to phone connector—10 meters
MU-KFTS15	FTA to IOP, phone to phone connector—15 meters
MU-KFTS20	FTA to IOP, phone to phone connector—20 meters
MU-KFTS25	FTA to IOP, phone to phone connector—25 meters
MU-KFTS30	FTA to IOP, phone to phone connector—30 meters
MU-KFTS35	FTA to IOP, phone to phone connector—35 meters
MU-KFTS40	FTA to IOP, phone to phone connector—40 meters
MU-KFTS45	FTA to IOP, phone to phone connector—45 meters
MU-KFTS50	FTA to IOP, phone to phone connector—50 meters
MU-KSPR00	Remote Power Distribution
MU-KSPR05	Remote Power Distribution—5 meters
MU-KSPR10	Remote Power Distribution—10 meters
MU-KSPR15	Remote Power Distribution—15 meters
MU-KSPR20	Remote Power Distribution—20 meters
MU-KSPR25	Remote Power Distribution—25 meters
MU-KSPR30	Remote Power Distribution—30 meters
MU-KSPR35	Remote Power Distribution—35 meters
MU-KSPR40	Remote Power Distribution—40 meters
MU-KSPR45	Remote Power Distribution—45 meters
MU-KSPR50	Remote Power Distribution—50 meters

Continued on next page

5.3 Mounting and Operating the HPM in a Division 2 Location,

Continued

Approved Division 2
area equipment,
continued

Table 5-2 HPM Equipment Approved for Use in Division 2 Areas,
Continued

Model Number	Description
Cables, continued	
MU-KFTD00	FTA to IOP, DIN to phone connector
MU-KFTD05	FTA to IOP, DIN to phone connector—5 meters
MU-KFTD10	FTA to IOP, DIN to phone connector—10 meters
MU-KFTD15	FTA to IOP, DIN to phone connector—15 meters
MU-KFTD20	FTA to IOP, DIN to phone connector—20 meters
MU-KFTD25	FTA to IOP, DIN to phone connector—25 meters
MU-KFTD30	FTA to IOP, DIN to phone connector—30 meters
MU-KFTD35	FTA to IOP, DIN to phone connector—35 meters
MU-KFTD40	FTA to IOP, DIN to phone connector—40 meters
MU-KFTD45	FTA to IOP, DIN to phone connector—45 meters
MU-KFTD50	FTA to IOP, DIN to phone connector—50 meters
MU-KDPR00	Power Distribution
MU-KDPR05	Power Distribution—5 meters
MU-KDPR10	Power Distribution—10 meters
MU-KDPR15	Power Distribution—15 meters
MU-KDPR20	Power Distribution—20 meters
MU-KDPR25	Power Distribution—25 meters
MU-KDPR30	Power Distribution—30 meters
MU-KDPR35	Power Distribution—35 meters
MU-KDPR40	Power Distribution—40 meters
MU-KDPR45	Power Distribution—45 meters
MU-KDPR50	Power Distribution—50 meters

Continued on next page

5.3 Mounting and Operating the HPM in a Division 2 Location,

Continued

Approved Division 2
area equipment,
continued

Table 5-2 HPM Equipment Approved for Use in Division 2 Areas,
Continued

Model Number	Description
Cables, continued	
MU-KLAM00	LLMux FTA to Power Adapter (internal to cabinet)
MU-KLX076	SDI, SI, LLMux, RHMUX FTA to Power Adapter – 76 meters (external to cabinet)
MU-KLX152	SDI, SI, LLMux, RHMUX FTA to Power Adapter – 152 meters (external to cabinet)
MU-KLX305	SDI, SI, LLMux, RHMUX FTA to Power Adapter – 305 meters (external to cabinet)
MU-KLO305	RHMUX FTA to Power Adapter – 305 meters (external to cabinet)
MU-KSX030	SDI/SI FTA to EIA-422/485—30 meters
MU-KSX152	SDI/SI FTA to EIA-422/485—152 meters
MU-KSX305	SDI/SI FTA to EIA-422/485—305 meters
MU-KGPR00	Galvanic Isolation Power Distribution Cable
MU-KGPR05	Galvanic Isolation Power Distribution Cable—5 meters
MU-KGPR10	Galvanic Isolation Power Distribution Cable—10 meters
MU-KBFT01	FTA I/O Bridge—0.5 meter
MU-KBFT02	FTA I/O Bridge—2 meters

Continued on next page

5.3 Mounting and Operating the HPM in a Division 2 Location,

Continued

Approved Division 2
area equipment,
continued

Table 5-2 HPM Equipment Approved for Use in Division 2 Areas,
Continued

Model Number	Description
UCN Cables	
MU-NKT002	UCN Trunk Cable—2.5 meters
MU-NKT005	UCN Trunk Cable—5 meters
MU-NKT010	UCN Trunk Cable—10 meters
MU-NKT020	UCN Trunk Cable—20 meters
MU-NKT030	UCN Trunk Cable—30 meters
MU-NKT050	UCN Trunk Cable—50 meters
MU-NKT100	UCN Trunk Cable—100 meters
MU-NKT200	UCN Trunk Cable—200 meters
MU-NKT400	UCN Trunk Cable—400 meters
MU-NKT600	UCN Trunk Cable—600 meters
MU-NKD000	UCN Drop Cable Set (pair)
MU-NKD002	UCN Drop Cable Set—2 meters (pair)
MU-NKD005	UCN Drop Cable Set—5 meters (pair)
MU-NKD010	UCN Drop Cable Set—10 meters (pair)
MU-NKD020	UCN Drop Cable Set—20 meters (pair)
MU-NKD030	UCN Drop Cable Set—30 meters (pair)
MU-NKD040	UCN Drop Cable Set—40 meters (pair)
MU-NKD050	UCN Drop Cable Set—50 meters (pair)
MU-NTAP02	UCN 2-Drop Tap Assembly Kit (pair)
MU-NTAP04	UCN 4-Drop Tap Assembly Kit (pair)
MU-NTAP08	UCN 8-Drop Tap Assembly Kit (pair)
MU-NKTK01	UCN Drop Connector Kit/RG-11
MU-NKDK01	UCN Drop Connector Kit/RG-6
MU-NCSK01	UCN Trunk Splice Kit

Continued on next page

5.3 Mounting and Operating the HPM in a Division 2 Location,

Continued

Approved Division 2
area equipment.
continued

Table 5-2 HPM Equipment Approved for Use in Division 2 Areas,
Continued

Model Number	Description
Power Systems	
MU-PSSX03	Power System, single Power Supply Module (PSM)
MU-PSRX03	Power System, redundant Power Supply Modules
MU-PSRB03	Power System, redundant PSMs with Battery Pack
MU-PSSX04	Power System, single Power Supply Module
MU-PSRX04	Power System, redundant Power Supply Modules
MU-PSRB04	Power System, redundant PSMs with Battery Pack
MU-PAS121	AC Only Power System, single PSM, 120 Vac 16 A
MU-PAR121	AC Only Power System, redund PSMs, 120 Vac 16 A
MU-PAS221	AC Only Power System, single PSM, 220 Vac 16 A
MU-PAR221	AC Only Power System, redund PSMs, 220 Vac 16 A
MU-PAS111	AC Only Power System, single PSM, 120 Vac 8 A
MU-PAR111	AC Only Power System, redundant PSMs, 120 Vac 8 A
MU-PAS211	AC Only Power System, single PSM, 220 Vac 8 A
MU-PAR211	AC Only Power System, redundant PSMs, 220 Vac 8 A
Standby Manual Devices	
MU-SMAC02	Analog Output Standby Manual Device with case and cable
MU-SMDC02	Digital Output Standby Manual Device with case
MU-SMDX02	Digital Output Standby Manual Device with cable
Miscellaneous	
MU-MASX02	Manual/Auto Station model PC6001U2M040A0

Continued on next page

5.3 Mounting and Operating the HPM in a Division 2 Location, Continued

Approved Division 2
area equipment,
continued

Table 5-2 HPM Equipment Approved for Use in Division 2 Areas,
Continued

Model Number	Description
Cabinet Hardware	
MU-CBDX01	Dual Access Cabinet, Rittal
MU-CBSX01	Single Access Cabinet, Rittal
MU-TMCN01	Narrow FTA Mounting Channel, Rittal
MU-TMCN02	Narrow FTA Mounting Channel with ground bar, Rittal
MU-TMCW01	Wide FTA Mounting Channel, Rittal
MU-TMCW02	Wide FTA Mounting Channel with ground bar, Rittal
MU-CBDM01	Dual Access Cabinet, NEMA 1
MU-CBSM01	Single Access Cabinet, NEMA 1
MU-TMCN11	Narrow FTA Mounting Channel, NEMA 1
MU-TMCN12	Narrow FTA Mounting Channel with ground bar, NEMA 1
MU-TMCW11	Wide FTA Mounting Channel, NEMA 1
MU-TMCW12	Wide FTA Mounting Channel with ground bar, NEMA 1
MU-TSGB01	FTA Shield Grounding Bar
Cabinet Fan Assemblies	
MU-FAN501	Cabinet Fan Assembly, 240 Vac
MU-FAN601	Cabinet Fan Assembly, 120 Vac
MU-FAN511	Cabinet Fan Assembly with alarm, 240 Vac
MU-FAN611	Cabinet Fan Assembly with alarm, 120 Vac

5.4 Field Wiring in Hazardous Locations

Nonincendive FTAs (current limiting)

Some of the Field Termination Assemblies (FTAs) that are used in the High-Performance Process Manager subsystem have resistors in the output circuits to limit the current available to the field terminals. These output circuits have been examined and certified by Factory Mutual as being Nonincendive.

This means that if the field wires are accidentally opened, shorted, or grounded and the HPM is operating normally, the wiring will not release enough energy to cause ignition in the specified flammable atmosphere.

Table 5-3 is a list of the analog input, analog output, and digital input FTAs that have Nonincendive outputs.

Also, when digital output circuits of a digital output FTA are current and voltage limited to suitable levels by the user, the digital output FTA can also be considered Nonincendive.

Cable and load parameters (entity parameters)

To ensure that the field circuits are incapable of igniting a specified flammable vapor, the size of the cable and load parameters must be known and controlled. Table 5-3 provides the maximum permissible values of the parameters for each of FTAs that are listed in the table.

Electrical code approval

In general, field wiring in Division 2 hazardous locations must be done according to local codes; however, in some jurisdictions, Nonincendive wires need not conform to the normal Division 2 wiring rules, but can use wiring methods that are suitable for ordinary locations.

See ANSI/ISA S12.12, the section “Electrical Equipment For Use In Class I, Division 2 Hazardous [Classified] Locations.”

Current limiting resistor value

The value of the resistors on the listed FTAs were selected to assure worst case short circuit currents in a hazardous area of less than 150 milliamps for normal operating equipment. According to NFPA publication #493, *Intrinsically Safe Apparatus for Use in Division 1 Hazardous Locations*, 150 milliamps from a 24 Vdc source is below the ignition threshold in a resistive circuit for gases in Groups A through D environments.

Continued on next page

5.4 Field Wiring in Hazardous Locations, Continued

Nonincendive FTAs

Wiring to the FTAs that are listed in Table 5-3 has been approved as Nonincendive wiring by Factory Mutual Research, Inc. When the wiring is opened, shorted, or grounded and the High-Performance Process Manager is in its normal operating state, the wiring cannot release enough energy to cause the ignition of a flammable atmosphere.

Table 5-3 Nonincendive FTA Types

FTA Type	FTA Models
Low Level Analog Input	MU/MC-TAIL01 MU/MC-TAIL02 MU/MC-TAIL03
High Level Analog Input	MU/MC-TAIH01 MU/MC-TAIH02 MU/MC-TAIH03 MU/MC-TAIH12 MU/MC-TAIH13 MU/MC-TAIH52 MU/MC-TAIH53
Smart Transmitter Interface Input	MU/MC-TSTX03 MU/MC-TSTX13 MU/MC-TSTX53
Pulse Input	MU/MC-TPIX12 MU/MC-TPIX52
4-20 mA Analog Output	MU/MC-TAOX01 MU/MC-TAOX02 MU/MC-TAOX12 MU/MC-TAOX52 MU/MC-TAOY22 MU/MC-TAOY23 MU/MC-TAOY52 MU/MC-TAOY53
24 Vdc Digital Input	MU/MC-DID11 MU/MC-DID12 MU/MC-DID52 MU/MC-DID72 MU/MC-DIY22 MU/MC-DIY62

Continued on next page

5.4 Field Wiring in Hazardous Locations, Continued

Cable size and load parameters

To ensure that the circuits are incapable of igniting a specific flammable atmosphere, the size of cable and load parameters must be controlled. The maximum values are given in Table 5-4.

Table 5-4 FTA Cable and Load Parameters

Parameter	Maximum Allowable Values					
	TPIX12 TPIX52	TAIL01 TAIL02 TAIL03	TAIH01 TAIH02 TAIH03 TAIH12 TAIH13 TAIH52 TAIH53 TSTX03 TSTX13 TSTX53	TAIH22 TAIH23 TAIH62	TAOX01 TAOX02 TAOX12 TAOX52 TAOY22 TAOY23 TAOY52 TAOY53	TDID12 TDID52 TDID72
VOC*—Maximum Open Circuit Voltage	26 Vdc	9 Vdc	26 Vdc	26 Vdc	26 Vdc	30 Vdc
ISC*—Maximum Short Circuit Current	63 mA	0.3 mA	186 mA	40 mA	22 mA	152 mA
C _a —Maximum Allowable Connected Cable Capacitance	0.4 μF	15 μF	0.4 μF	0.4 μF	0.4 μF	0.25 μF
L _a —Maximum Allowable Cable Inductance	17 mH	1 H	2.3 mH	35 mH	130 mH	3 mH
C _n —Maximum Allowable Connected Capacitance (Cable + Load)	0.4 μF	15 μF	0.4 μF	0.4 μF	0.4 μF	0.25 μF
L _n —Maximum Allowable Connected Inductance (Cable + Load)	17 mH	1 H	150 mH	150 mH	130 mH	400 mH

* Controlled by the High-Performance Process Manager design.

ATTENTION

ATTENTION—The data in Table 5-4 is controlled by the Honeywell drawing 51109499 and cannot be changed without the approval of Factory Mutual Research, Inc.

Section 6 – Corrosion Protection Planning

6.1 Overview

Section contents The topics covered in this section are:

	Topic	See Page
6.1	Overview.....	103
6.2	Model Numbers.....	106

Introduction

Corrosion is one of the leading causes of electronic printed circuit assembly board failure in harsh environments. Conformal coating of the assembly’s printed circuits and components provides a solution for the problem. Conformally coated assemblies are completely covered with a thin layer of a special plastic material that is resistant to the corrosive effects of humidity and most chemical gases.

ATTENTION

Table 6-1 recommends the minimum equipment requirement that is based on environmental classification tests at the site where the equipment is installed.

Table 6-1 Environment Minimum Equipment Requirement

Environment Classification	Minimum Equipment Requirement
Mild (G1)	Non-conformally coated
Moderate (G2)	Conformally coated
Harsh (G3)	Conformally coated
Severe (Gx)	Conformally coated and installed in an environmentally hardened enclosure

G3 rating

All coated assemblies will withstand the effects of a G3 (harsh) rated environment. Uncoated boards are rated for mild (G1) environments. A harsh environment is defined by ANSI/ISA-S71.04-1985, “Environmental Conditions for Process Measurement and Control Systems: Airborne Contaminates.”

Continued on next page

6.1 Overview, Continued

Environmental harshness levels

Table 6-2 defines environmental harshness levels for airborne contaminants.

Table 6-2 Harsh Environment Definitions from ANSI/ISA-S71.04-1985

Severity Level		G1 (Mild)	G2 (Moderate)	G3 (Harsh)	Gx (Severe)
Copper Reactivity Level (Angstroms/Month)		<300	<1000	<2000	≥2000
Contaminant Gas		Concentration (Parts/Billion)			
Group A	H₂S	<3	<10	<50	≥50
	SO₂, SO₃	<10	<100	<300	≥300
	Cl₂	<1	<2	<10	≥10
	NO_x	<50	<125	<1250	≥1250
Group B	HF	<1	<2	<10	≥10
	NH₃	<500	<10,000	<25,000	≥25,000
	O₃	<2	<25	<100	≥100

Gas concentrations

Gas concentrations are for reference purposes only and are believed to approximate the reactivity levels, assuming relative humidity is less than 50%. For each 10% increase in relative humidity above 50%, or change in relative humidity by greater than 6%/hour, the severity level can be expected to increase by one level.

Continued on next page

6.1 Overview, Continued

Conformal coating symbol

Conformally coated assemblies can be easily identified by a distinctive symbol located on the assembly. The symbol consists of a “C” that is surrounded by a solid diamond. The diamond universally symbolizes hardness. The symbol is intended to represent the hardened protection against harsh environments that conformal coating provides. Figure 6-1 illustrates the symbol on the faceplate of an Analog Output IOP.

Figure 6-1 Conformal Coating Symbol

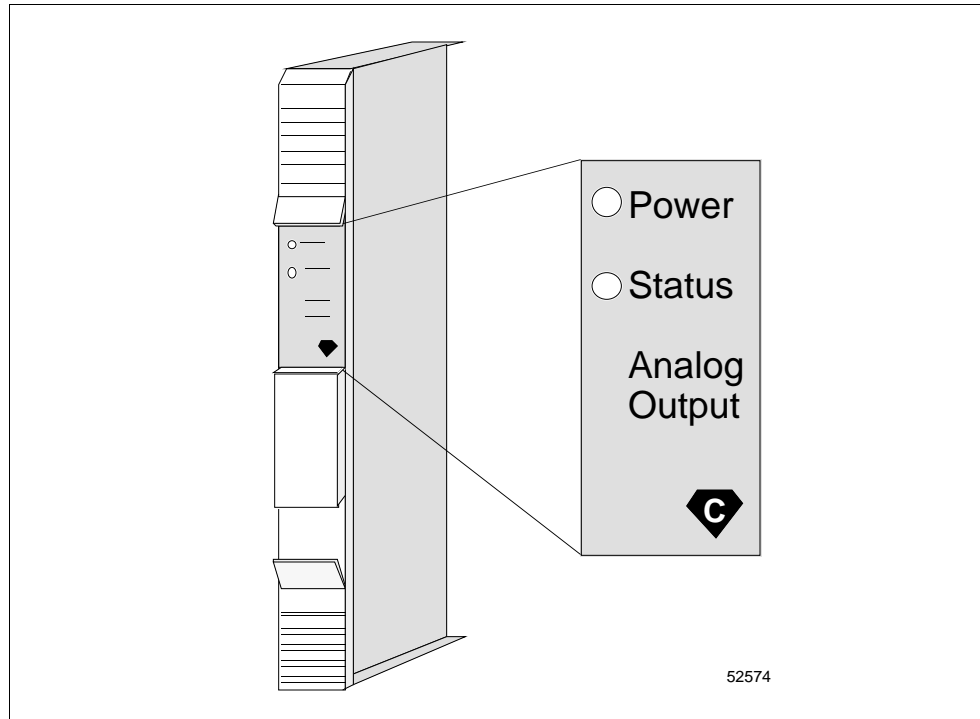

Harsh Environment Enclosure

For those users who want to locate their IOPs closer to the process and outside the control room in a severe environment, another level of protection is required. Honeywell offers the availability of a harsh environment IOP enclosure that is capable of withstanding a Gx rated atmosphere. The product includes a sealed NEMA 4x stainless steel enclosure, a special 7-Slot card file with fans for air circulation to house conformally coated IOP and I/O Link Extender cards, and a 24 Vdc Power System that uses components found in the HPM AC Only Power System. There is no active external cooling required for external ambient temperatures of up to 60°C. The IOPs interface with the HPMM(s) in the control room by fiber optic I/O Link Extender. Standard IOP to FTA cables that are enclosed in sealed conduit provide the IOP to associated FTA interface. The FTAs are mounted in sealed NEMA 4x stainless steel enclosures that are provided by the user.

6.2 Model Numbers

Model numbers

Model numbers for conformally coated assemblies and upgrade kits are identified by a “MC” prefix, instead of the normal “MU” prefix for a noncoated assembly. An example would be a conformally coated Low Level Analog Input IOP. Its model number is MC-PAIL02. The model number of the noncoated version of the IOP is MU-PAIL02.

ATTENTION

ATTENTION—The High Level Analog Input and Analog Output IOPs are available only as conformally coated assemblies. There are no noncoated versions available. The model numbers are MC-PAIH03 and MC-PAOX03, respectively.

Assembly numbers

Typically, the part number’s tab for a conformally coated assembly has the format “x5x” (non-CE Compliant) or “x7x” (CE Compliant), where “x” can be any number, 1 through 9. This provides a standard method of identifying conformally coated assemblies.

Continued on next page

6.2 Model Numbers, Continued

Conformally coated model list

Table 6-3 is a list of conformally coated High-Performance Process Manager assemblies.

Table 6-3 Conformally Coated Assembly Model Numbers

Model Number	Non CE Compliant Part Number	CE Compliant Part Number	Description
IOPs			
MC-PAIH03	N/A	51304754-150	High Level Analog Input (HLAI)
MC-PAIL02	N/A	51304481-150	Low level Analog Input (LLAI)
MC-PAOX03	51304672-150	51309152-175	Analog Output (AO)
MC-PAOY22	N/A	80363969-150	Analog Output (AO)
MC-PDIS12	N/A	51402625-175	Digital Input Sequence of Events (DI)
MC-PDIX02	N/A	51304485-150	Digital Input (DI)
MC-PDIY22	N/A	80363972-150	Digital Input (DI)
MC-PDOX02	N/A	51304487-150	Digital Output (DO)
MC-PDOY22	N/A	80363975-150	Digital Output (DO)
MC-PLAM02	N/A	51304362-150	Low Level Multiplexer (LLMux)
MC-PRHM01	N/A	51404109-175	Remote Hardened Low Level Multiplexer (RHMUX)
MC-PPIX02	N/A	51304386-150	Pulse Input (PI)
MC-PSDX02	N/A	51304362-250	Serial Device Interface (SDI)
MC-PSIM11	N/A	51304362-350	Serial Interface (SI)
MC-PSTX02	51304516-150	N/A	Smart Transmitter Interface (STI)
MC-PSTX03	N/A	51304516-250	Smart Transmitter Interface Multivariable (STIM)
Standard FTAs			
MC-TAIH02	51304453-150	N/A	High Level Analog Input/STI with compression term
MC-TAIH03	N/A	51309136-175	High Level Analog Input with compression terminals
MC-TAIH12	51304337-150	N/A	High Level Analog Input/STI with compression term
MC-TAIH13	N/A	51309138-175	High Level Analog Input with compression terminals
MC-TAIH22	80366195-150	N/A	High Level Analog Input/STI with compression term
MC-TAIH23	N/A	80366195-175	High Level Analog Input with compression terminals
MC-TAIH52	51304337-250	N/A	High Level Analog Input/STI with screw terminals

Continued on next page

6.2 Model Numbers, Continued

Conformally coated model list, continued

Table 6-3 Conformally Coated Assembly Model Numbers, Continued

Model Number	Non CE Compliant Part Number	CE Compliant Part Number	Description
Standard FTAs, continued			
MC-TAIH53	N/A	51309138-275	High Level Analog Input with screw terminals
MC-TAIH62	80366192-150	N/A	High Level Analog Input/STI with screw terminals
MC-TSTX03	N/A	51309140-175	Smart Transmitter Interface with Compression Term
MC-TSTX13	N/A	51309142-175	Smart Transmitter Interface with Compression Term
MC-TSTX53	N/A	51309142-275	Smart Transmitter Interface with Screw Terminals
MC-TAIL02	51304437-150	N/A	Low Level Analog Input with compression terminals
MC-TAIL03	N/A	51309202-175	Low Level Analog Input with compression terminals
MC-TAMR02	51304477-150	N/A	LLMux Analog Input RTD with compression terminals
MC-TAMR03	N/A	51309218-175	LLMux Analog Input RTD with compression terminals
MC-TAMT02	51401491-150	N/A	LLMux Analog Input TC with compression terminals
MC-TAMT03	N/A	51301491-175	LLMux Analog Input TC with compression terminals
MC-TAMT12	51401573-150	N/A	LLMux Analog Input TC with remote CJR, comp term
MC-TAMT13	N/A	51301573-175	LLMux Analog Input TC with remote CJR, comp term
MC-TAOX02	51304476-150	51304476-175	Analog Output with compression terminals
MC-TAOX12	51304335-150	51304335-175	Analog Output with compression terminals
MC-TAOX52	51304335-250	51304335-275	Analog Output with screw terminals
MC-TAOY22	80366177-150	80366177-175	Analog Output with compression terminals
MC-TAOY23	80366177-250	80366177-275	Analog Output with compression terminals
MC-TAOY52	80364007-150	80364007-175	Analog Output with screw terminals
MC-TAOY53	80364007-250	80364007-275	Analog Output with screw terminals
MC-TDIA12	51304439-150	51304439-175	120 Vac Digital Input with compression terminals
MC-TDIA52	51304439-250	51304439-275	120 Vac Digital Input with fixed-screw terminals
MC-TDIA72	51303930-150	N/A	120 Vac Digital Input with removable-screw terminals
MC-TDIA22	51304431-150	51304431-175	240 Vac Digital Input with compression terminals

Continued on next page

6.2 Model Numbers, Continued

Conformally coated
model list, continued

Table 6-3 Conformally Coated Assembly Model Numbers, Continued

Model Number	Non CE Compliant Part Number	CE Compliant Part Number	Description
Standard FTAs, continued			
MC-TDIA62	51304431-250	51304431-275	240 Vac Digital Input with fixed-screw terminals
MC-TDID12	51304441-150	51304441-175	24 Vdc Digital Input with compression terminals
MC-TDID52	51304441-250	51304441-275	24 Vdc Digital Input with fixed-screw terminals
MC-TDID72	51303928-150	N/A	24 Vdc Digital Input with removable-screw terminals
MC-TDIY22	80366180-150	80366180-175	24 Vdc Digital Input with compression terminals
MC-TDIY62	80366180-250	80366180-275	24 Vdc Digital Input with fixed-screw terminals
MC-TDOA13	51304648-150	51304648-175	120/240 Vac Solid-State Digital Output w/comp term
MC-TDOA53	51304648-250	51304648-275	120/240 Vac Solid-State Digital Output w/screw term
MC-TDOD13	51304650-150	N/A	3-30 Vdc Digital Output with compression terminals
MC-TDOD14	N/A	51309153-175	3-30 Vdc Digital Output with compression terminals
MC-TDOD22	51304428-150	N/A	31-200 Vdc Digital Output with compression terminals
MC-TDOD23	N/A	51309154-175	31-200 Vdc Digital Output with compression terminals
MC-TDOD53	51304650-250	N/A	3-30 Vdc Digital Output with screw terminals
MC-TDOD54	N/A	51309153-275	3-30 Vdc Digital Output with screw terminals
MC-TDOD62	51304428-250	N/A	31-200 Vdc Digital Output with screw terminals
MC-TDOD63	N/A	51309154-275	31-200 Vdc Digital Output with screw terminals
MC-TDON12	51304446-150	N/A	24 Vdc Nonisolated Digital Output with comp term
MC-TDON52	51304446-250	N/A	24 Vdc Nonisolated Digital Output with screw term
MC-TDOY22	80366183-150	80366183-175	24 Vdc Isolated Digital Output with compression term
MC-TDOY62	80364013-150	80364013-175	24 Vdc Isolated Digital Output with screw terminals
MC-TDOR12	51304443-150	51309148-175	120 Vac/125 Vdc Relay Digital Output with comp term
MC-TDOR52	51304443-250	51309148-275	120 Vac/125 Vdc Relay Digital Output with screw term
MC-TDOR22	51304427-150	51309150-175	240 Vac/125 Vdc Relay Digital Output with comp term
MC-TDOR62	51304427-250	51309150-275	240 Vac/125 Vdc Relay Digital Output with screw term

Continued on next page

6.2 Model Numbers, Continued

Conformally coated model list, continued

Table 6-3 Conformally Coated Assembly Model Numbers, Continued

Model Number	Non CE Compliant Part Number	CE Compliant Part Number	Description
Standard FTAs, continued			
MC-TDOY23	80366189-150	80366189-175	240 Vac/125 Vdc Relay Digital Output with comp term
MC-TDOY63	80366185-150	80366185-175	240 Vac/125 Vdc Relay Digital Output with screw term
MC-TDPR02	51304425-150	51304425-175	Digital Input Power Distribution Assembly
MC-TLPA02	51304467-150	51309204-175	Power Adapter
MC-TPIX12	51304084-150	51304084-175	Pulse Input with compression terminals
MC-TPIX52	51304084-250	51304084-275	Pulse Input with screw terminals
MC-TSDM02	51303932-252	N/A	Serial Device Interface—Manual/Auto Station
MC-TSDT02	51303932-251	N/A	Serial Device Interface—Toledo Weigh Cell
MC-TSDU02	51303932-253	N/A	Serial Device Interface—UDC 6000 Modbus
MC-TSIA12	51303932-453	51303932-478	Serial Interface—Allen-Bradley
MC-TSIM12	51303932-451	51303932-476	Serial Interface—Modbus EIA-232
Galvanically Isolated FTAs			
MC-GRMT01	N/A	51404106-175	RHMUX Analog Input with local CJR, screw term
MC-GRPA01	N/A	51304724-175	RHMUX GI/IS Power Adapter with compression term
MC-TRPA01	N/A	51304722-175	RHMUX GI/NI Power Adapter with compression term
MC-GAIH12	51304636-150	N/A	High Level Analog Input with compression terminals
MC-GAIH13	51304718-150	51304718-175	High Level Analog Input/STI with compression term
MC-GAIH14	51304730-150	51304730-175	High Level Analog Input/STI with compression term
MC-GAIH22	51304748-150	51304748-175	High Level Analog Input with compression terminals
MC-GAIH82	51304636-350	N/A	High Level Analog Input with crimp terminals
MC-GAIH83	51304718-350	51304718-375	High Level Analog Input/STI with crimp terminals
MC-GAIH84	51304730-350	51304730-375	High Level Analog Input/STI with crimp terminals
MC-GAIH92	51304748-350	51304748-375	High Level Analog Input with crimp terminals
MC-GAOX02	51304638-150	51304638-175	Nonredundant Analog Output with compression term

Continued on next page

6.2 Model Numbers, Continued

Conformally coated model list, continued

Table 6-3 Conformally Coated Assembly Model Numbers, Continued

Model Number	Non CE Compliant Part Number	CE Compliant Part Number	Description
Galvanically Isolated FTAs, continued			
MC-GAOX12	51304638-250	51304638-275	Redundant Analog Output with compression terminal
MC-GAOX72	51304638-350	51304638-375	Nonredundant Analog Output with crimp terminals
MC-GAOX82	51304638-750	51304638-775	Redundant Analog Output with crimp terminals
MC-GDID12	51304640-150	51304640-175	Digital Input with compression terminals
MC-GDID13	51304728-150	51304728-175	Digital Input with compression terminals
MC-GDID82	51304640-350	51304640-375	Digital Input with crimp terminals
MC-GDID83	51304728-350	51304728-375	Digital Input with crimp terminals
MC-GDOD12	51304642-150	51304642-175	24 Vdc Digital Output with compression terminals
MC-GDOD82	51304642-350	51304642-375	24 Vdc Digital Output with crimp terminals
MC-GDOL12	51304736-150	51304736-175	24 Vdc Digital Output with compression terminals
MC-GDOL82	51304736-350	51304736-375	24 Vdc Digital Output with crimp terminals
MC-GLFD02	51304732-150	51304732-175	Combiner Panel
MC-GMAR52	51304646-150	51309156-175	Marshalling Panel
MC-GPRD02	51304644-150	51304644-175	Power Distribution Assembly
I/O Link Extender			
MC-IOLM02			Standard I/O Link Extender—Local Card File
	N/A	51304419-150	Standard I/O Link Extender Card
	N/A	51201557-350	Standard I/O Link Extender Coupler
MC-IOLX02			Standard I/O Link Extender—Remote Card File
	N/A	51304419-150	Standard I/O Link Extender Card
	N/A	51201557-150	Standard I/O Link Extender Coupler
MC-ILD03			Long Distance I/O Link Extender
	N/A	51304532-150	Long Distance I/O Link Extender Card
	N/A	51309208-150	Long Distance I/O Link Extender Coupler

Continued on next page

6.2 Model Numbers, Continued

Conformally coated model list, continued

Table 6-3 Conformally Coated Assembly Model Numbers, Continued

Model Number	Non CE Compliant Part Number	CE Compliant Part Number	Description
Card Files			
MC-HPFH01	51404125-150	N/A	Left 7-Slot Card File Assembly
MC-HPFH03	N/A	51404191-175	Left 7-Slot HPMM Card File Assembly
MC-HPFH11	51404126-150	N/A	Right 7-Slot Card File Assembly
MC-HPFH13	N/A	51404192-175	Right 7-Slot HPMM Card File Assembly
MC-HPFX02	51404127-150	N/A	15-Slot Card File Assembly
MC-HPFX03	N/A	51404193-175	15-Slot HPMM Card File Assembly
MC-HPFI03	N/A	51404191-275	Left 7-Slot IOP Card File Assembly
MC-HPFI13	N/A	51404192-275	Right 7-Slot IOP Card File Assembly
MC-HPFI23	N/A	51404193-275	15-Slot IOP Card File Assembly
HPMM Card Sets			
MC-HPMS01			Nonredundant HPMM Card Set
	N/A	51301635-150	High-Performance Comm/Control Card
	N/A	51301642-150	High-Performance I/O Link Card
	N/A	51302573-150	HPM UCN Interface Module
MC-HPMR01			Redundant HPMM Card Sets
	N/A	51301635-150	High-Performance Comm/Control Card (2)
	N/A	51301642-150	High-Performance I/O Link Card (2)
	N/A	51302573-150	HPM UCN Interface Module (2)
	N/A	51201667-100	Redundancy Cable

Continued on next page

6.2 Model Numbers, Continued

Conformally coated model list, continued

Table 6-3 Conformally Coated Assembly Model Numbers, Continued

Model Number	Non CE Compliant Part Number	CE Compliant Part Number	Description
Power System			
MC-PSSX03	N/A	51401217-450	Power System, single Power Supply Module
MC-PSSX04	N/A	51404174-175	Power System, single Power Supply Module
MC-PSRX03	N/A	51401217-550	Power System, redundant Power Supply Modules
MC-PSRX04	N/A	51404174-275	Power System, redundant Power Supply Modules
MC-PSRB03	N/A	51401217-650	Power System, redundant PSMs with Battery Pack
MC-PSRB04	N/A	51404174-375	Power System, redundant PSMs with Battery Pack
MC-PAS121	51401140-150	N/A	AC Only Power System, single PSM, 115 Vac 16 A
MC-PAR121	51401140-250	N/A	AC Only Power System, redund PSMs, 115 Vac 16 A
MC-PAS221	51401140-350	N/A	AC Only Power System, single PSM, 230 Vac 16 A
MC-PAR221	51401140-450	N/A	AC Only Power System, redund PSMs, 230 Vac 16 A
MC-PAS111	51401140-550	N/A	AC Only Power System, single PSM, 115 Vac 8 A
MC-PAR111	51401140-650	N/A	AC Only Power System, redund PSMs, 115 Vac 8 A
MC-PAS211	51401140-750	N/A	AC Only Power System, single PSM, 230 Vac 8 A
MC-PAR211	51401140-850	N/A	AC Only Power System, redund PSMs, 230 Vac 8 A
Standby Manual Devices			
MC-SMAC02	N/A	51401277-250	Analog Output Standby Manual Device w/case, cable
MC-SMDC02	N/A	51304526-150	Digital Output Standby Manual Device w/case, cable
MC-SMDX02	N/A	51304527-150	Digital Output Standby Manual Device with cable
Cabinet Fan Assemblies			
MC-FAN511			Cabinet Fan Assembly with alarm, 240 Vac
	N/A	51303940-250	Cabinet Fan Assembly with alarm, 240 Vac
MC-FAN611			Cabinet Fan Assembly with alarm, 120 Vac
	N/A	51303940-150	Cabinet Fan Assembly with alarm, 120 Vac

Continued on next page

6.2 Model Numbers, Continued

Conformally coated model list, continued

Table 6-3 Conformally Coated Assembly Model Numbers, Continued

Model Number	Non CE Compliant Part Number	CE Compliant Part Number	Description
Miscellaneous			
MC-CBSS01			NEMA 4x Stainless Steel Enclosure (.6 m W x .5 m D x .6 m H) with Left 7-Slot card file
MC-CBSS02			NEMA 4x Stainless Steel Enclosure (.6 m W x .5 m D x .6 m H) with Right 7-Slot card file

Section 7 – CE Compliance

7.1 Overview

Section contents The topics covered in this section are:

	Topic	See Page
7.1	Overview.....	115
7.2	Card Files.....	116
7.3	HPMM Cards.....	117
7.4	IOPs.....	117
7.5	FTAs.....	120
7.6	I/O Link Extender.....	129
7.7	IOP to FTA Cables.....	130
7.8	Power Cables.....	131
7.9	I/O Link Interface Cables.....	136
7.10	UCN Trunk Cable Taps.....	137
7.11	Cabinets.....	139

Introduction To meet CE Compliance directives, card files, High-Performance Process Manager Module (HPMM) cards, Field Termination Assemblies (FTAs), Power Systems, and cables, namely IOP to FTA cables, power cables, and I/O Link Interface cables, are available and identified either by model number or by the assembly part number.

Hardware differences Where applicable, this section describes general differences between the CE Compliant hardware and non-CE Compliant hardware.

Also discussed are the hardware combinations and rules that must be considered for CE Compliance.

CE Compliant hardware identification Finally, where applicable, each subsection that is devoted to a particular type of hardware identifies the CE Compliant and the non-CE Compliant hardware.

Master Reference Ground The use of a Master Reference Ground (MRG), which is separate from Safety Ground, is not acceptable for a CE Compliant installation. References to Master Reference Ground must be ignored and a single Safety Ground must be substituted.

CE Compliant installation Only recommended CE Compliant hardware, cabling, and practices must be considered for a CE Compliant installation. Install only a single ground system.

7.2 Card Files

Introduction

All three card file types are available for CE Compliant applications. The CE Compliant models have three unique features. They are

- Filtered backpanel IOP connectors
- IOP connector ground panel(s)
- Rear backpanel shield

Unlike the non-CE Compliant 7-Slot and 15-Slot card files that are not dedicated HPMM or IOP card files, the CE-Compliant 7-Slot and 15-Slot card files are mechanically either HPMM or IOP card files. 7-Slot or 15-Slot IOP card files will not accept an HPMM card set.

Backpanel ground plane

The backpanel ground panel provides a ground plane for the body of the IOP connectors. The body of the connector in turn provides ground for the IOP to FTA cable shield when mated with the IOP connector.

Rear backpanel shield panel

Like the UCN connector shield enclosure, the backpanel shield panel provides EMI protection at the back of the backpanel.

IOP to FTA cables

Both the model MU-KFTAxx and MU-KFTSxx IOP to FTA cables can be used with both the CE Compliant and non-CE Compliant card files. However, only the CE Compliant card file models and the model MU-KFTSxx IOP to FTA cables together are acceptable as CE Compliant.

Model list

Table 7-1 lists the model numbers of the CE Compliant card files. All models are available without conformal coating (MU) and with conformal coating (MC). The PM/APM technology IOP Only card file is also included because it may exist when a PM or APM is upgraded to an HPM.

Table 7-1 Card Files

Card File Description	Non-Conformally Coated Model Number	Conformally Coated Model Number
Left 7-Slot HPMM	MU-HPFH03	MC-HPFH03
Right 7-Slot HPMM	MU-HPFH13	MC-HPFH13
15-Slot HPMM	MU-HPFX03	MC-HPFX03
Left 7-Slot IOP	MU-HPFI03	MC-HPFI03
Right 7-Slot IOP	MU-HPFI13	MC-HPFI13
15-Slot IOP	MU-HPFI23	MC-HPFI23
IOP Only (PM/APM)	MU-IOFX03	MC-IOFX03

Continued on next page

7.2 Card Files, Continued

Conversion kit A model MU-ZPFI03 upgrade kit will convert a 7-Slot or 15-Slot HPMM card file to an IOP card file.

7.3 HPMM Cards

Introduction The High-Performance Process Manager Module (HPMM) card set is CE Compliant.

Conformal coating The HPMM card set is available with and without conformal coating.

7.4 IOPs

Introduction Only the model MU-PAOX03 Analog Output IOP is available in a CE Compliant and non-CE Compliant version. All other IOP models are CE Compliant only.

Conformal coating All IOP cards are available with and without conformal coating.

Continued on next page

7.4 IOPs, Continued

Nonconformally coated IOPs Table 7-2 lists the model numbers of the CE Compliant and non-CE Compliant IOP cards that are not conformally coated. Model numbers and part numbers identify the assemblies.

Table 7-2 IOPs—Nonconformally Coated

IOP Type	Model Number	Non-CE Compliant Part Number	CE Compliant Part Number
LLAI	MU-PAIL02	N/A	51304481-100
LLMux	MU-PLAM02	N/A	51304362-100
RHMUX	MU-PRHM01	N/A	51404109-125
HLAI	MU-PAIH03	N/A	51304754-100
STIM	MU-PSTX03	N/A	51304516-200
AO	MU-PAOX03	51304672-100	51309152-125
AO	MU-PAOY22	N/A	80363969-100
DI	MU-PDIX02	N/A	51304485-100
DI	MU-PDIY22	N/A	80363972-100
DISOE	MU-PDIS12	51402625-125	N/A
DO	MU-PDOX02	N/A	51304487-100
DO	MU-PDOY22	N/A	80363975-100
PI	MU-PPIX02	N/A	51304386-100
SDI	MU-PSDX02	N/A	51304362-200
SI	MU-PSIM11	N/A	51304362-300

Continued on next page

7.4 IOPs, Continued

Conformally coated IOPs

Table 7-3 lists the model numbers of the CE Compliant and non-CE Compliant IOP cards that are conformally coated. Model numbers and part numbers identify the assemblies.

Table 7-3 IOPs—Conformally Coated

IOP Type	Model Number	Non-CE Compliant Part Number	CE Compliant Part Number
LLAI	MC-PAIL02	N/A	51304481-150
LLMux	MC-PLAM02	N/A	51304362-150
RHMUX	MC-PRHM01	N/A	51404109-175
HLAI	MC-PAIH03	N/A	51304754-150
STI	MC-PSTX02	N/A	51304516-150
STIM	MC-PSTX03	N/A	51304516-250
AO	MC-PAOX03	51304672-150	51309152-175
AO	MC-PAOY22	N/A	80363969-150
DI	MC-PDIX02	N/A	51304485-150
DI	MC-PDIY22	N/A	80363972-150
DISOE	MC-PDIS12	N/A	51402625-175
DO	MC-PDOX02	N/A	51304487-150
DO	MC-PDOY22	N/A	80363975-150
PI	MC-PPIX02	N/A	51304386-150
SDI	MC-PSDX02	N/A	51304362-250
SI	MC-PSIM11	N/A	51304362-350

7.5 FTAs

Introduction

Many types of FTAs are available that are CE Compliant. Some are identified by a model number that is different than the model number for the non-CE Compliant FTA. Other CE Compliant FTA types have the same model number as the non-CE Compliant FTA, but are generally identified by the tab number of the part number that ends in “25.”

The CE Compliant FTAs feature filtered connectors to interface the CE Compliant model MU-KFTSxx IOP to FTA cable(s).

Conformal coating

All FTAs are available with and without conformal coating.

Nonconformally coated FTAs

Table 7-4 is a list of CE Compliant and non-CE Compliant FTAs that are not conformally coated. Model numbers and part numbers identify the assemblies.

Table 7-4 Field Termination Assemblies—Nonconformally Coated

FTA Type	Model Number	Non-CE Compliant Part Number	CE Compliant Part Number
LLAI	MU-TAIL02	51304437-100	N/A
LLAI	MU-TAIL03	N/A	51309202-125
LLMux RTD	MU-TAMR02	51304477-100	N/A
LLMux RTD	MU-TAMR03	N/A	51309218-125
LLMux TC	MU-TAMT02	51401491-100	N/A
LLMux TC	MU-TAMT03	N/A	51309223-125
LLMux TC Remote	MU-TAMT12	51401573-100	N/A
LLMux TC Remote	MU-TAMT13	N/A	51309213-125
RHMUX GI/IS Power Adapter	MU-GRPA01	N/A	51304724-125
RHMUX GI/NI Power Adapter	MU-TRPA01	N/A	51304722-125
HLAI/STI	MU-TAIH02	51304453-100	N/A
HLAI/STI	MU-TAIH12	51304337-100	N/A
HLAI/STI	MU-TAIH22	80366195-100	N/A
HLAI/STI	MU-TAIH52	51304337-200	N/A
HLAI/STI	MU-TAIH62	80366192-100	N/A
HLAI	MU-TAIH03	N/A	51309136-125
HLAI	MU-TAIH13	N/A	51309138-125

Continued on next page

7.5 FTAs, Continued

Nonconformally coated FTAs, continued

Table 7-4 Field Termination Assemblies—Nonconformally Coated, Continued

FTA Type	Model Number	Non-CE Compliant Part Number	CE Compliant Part Number
HLAI	MU-TAIH23	N/A	80369165-125
HLAI	MU-TAIH53	N/A	51309138-225
STI	MU-TSTX03	N/A	51309136-125
STI	MU-TSTX13	N/A	51309138-125
STI	MU-TSTX53	N/A	51309138-225
AO	MU-TAOX02	51304476-100	51304476-125
AO	MU-TAOX12	51304335-100	51304335-125
AO	MU-TAOX52	51304335-200	51304335-225
AO	MU-TAOY22	80366177-100	80366481-125
AO	MU-TAOY23	80366177-200	N/A
AO	MU-TAOY52	80364007-100	80366484-125
AO	MU-TAOY53	80364007-200	N/A
24 Vdc DI	MU-TDID12	51304441-100	51304441-125
24 Vdc DI	MU-TDID52	51304441-200	51304441-225
24 Vdc DI	MU-TDID72	51303928-100	N/A
24 Vdc DI	MU-TDIY22	80366180-100	80366180-125
24 Vdc DI	MU-TDIY62	80364010-100	80364010-125
120 Vac DI	MU-TDIA12	51304439-100	51304439-125
120 Vac DI	MU-TDIA52	51304439-200	51304439-225
120 Vac DI	MU-TDIA72	51303930-100	N/A
240 Vac DI	MU-TDIA22	51304431-100	51304431-125
240 Vac DI	MU-TDIA62	51304431-200	51304431-225
24 Vdc Nonisolated DO	MU-TDON12	51304446-100	N/A
24 Vdc Nonisolated DO	MU-TDON52	51304446-200	N/A
24 Vdc Isolated DO	MU-TDOY22	80366183-100	80366183-125

Continued on next page

7.5 FTAs, Continued

Nonconformally coated FTAs, continued

Table 7-4 Field Termination Assemblies—Nonconformally Coated, Continued

FTA Type	Model Number	Non-CE Compliant Part Number	CE Compliant Part Number
24 Vdc Isolated DO	MU-TDOY62	80364013-100	80364013-125
3-30 Vdc SS DO	MU-TDOD12	51304423-100	N/A
3-30 Vdc SS DO	MU-TDOD13	51304650-100	N/A
3-30 Vdc SS DO	MU-TDOD14	N/A	51309153-125
3-30 Vdc SS DO	MU-TDOD52	51304423-200	N/A
3-30 Vdc SS DO	MU-TDOD53	51304650-200	N/A
3-30 Vdc SS DO	MU-TDOD54	N/A	51309153-225
31-200 Vac SS DO	MU-TDOD22	51304428-100	N/A
31-200 Vac SS DO	MU-TDOD23	N/A	51309154-125
31-200 Vac SS DO	MU-TDOD62	51304428-200	N/A
31-200 Vac SS DO	MU-TDOD63	N/A	51309154-225
120/240 Vac SS DO	MU-TDOA12	51304408-100	N/A
120/240 Vac SS DO	MU-TDOA13	51304648-100	51304648-125
120/240 Vac SS DO	MU-TDOA52	51304408-200	N/A
120/240 Vac SS DO	MU-TDOA53	51304648-200	51304648-225
120 Vac/125 Vdc Relay DO	MU-TDOR12	51304443-100	51309148-125
120 Vac/125 Vdc Relay DO	MU-TDOR52	51304443-200	51309148-225
240 Vac/125 Vdc Relay DO	MU-TDOR22	51304427-100	51309150-125
240 Vac/125 Vdc Relay DO	MU-TDOR62	51304427-200	51309150-225
240 Vac/125 Vdc Relay DO	MU-TDOY23	80366189-100	80366189-125
240 Vac/125 Vdc Relay DO	MU-TDOY63	80366185-100	80366185-125
PI	MU-TPIX12	51304084-100	51304084-125
PI	MU-TPIX52	51304084-200	51304084-225

Continued on next page

7.5 FTAs, Continued

Nonconformally coated FTAs, continued

Table 7-4 Field Termination Assemblies—Nonconformally Coated, Continued

FTA Type	Model Number	Non-CE Compliant Part Number	CE Compliant Part Number
SDI—Toledo	MU-TSDT02	51303932-201	N/A
SDI—Manual/Auto	MU-TSDM02	51303932-202	N/A
SDI—Toledo	MU-TSDU02	51303932-203	N/A
SI—Modbus	MU-TSIM12	51303932-401	51303932-426
SI—Allen-Bradley	MU-TSIA12	51303932-403	51303932-428
Power Adapter	MU-TLPA02	51304467-100	51309204-125
DI Power Dist Assembly	MU-TDPR02	51304425-100	51304425-125
GI Power Dist Assembly	MU-GPRD02	51304644-100	51304644-125
GI HLAI/STI	MU-GAIH13	51304718-100	51304718-125
GI HLAI/STI	MU-GAIH14	51304730-100	51304730-125
GI HLAI/STI	MU-GAIH83	51304718-300	51304718-325
GI HLAI/STI	MU-GAIH84	51304730-300	51304730-325
GI HLAI	MU-GAIH12	51304636-100	N/A
GI HLAI	MU-GAIH22	51304748-100	51304748-125
GI HLAI	MU-GAIH82	51304636-300	N/A
GI HLAI	MU-GAIH92	51304748-300	51304748-325
GI AO	MU-GAOX02	51304638-100	51304638-125
GI AO	MU-GAOX12	51304638-500	51304638-525
GI AO	MU-GAOX72	51304638-300	51304638-325
GI AO	MU-GAOX82	51304638-700	51304638-725
GI 24 Vdc DI	MU-GDID12	51304640-100	51304640-125
GI 24 Vdc DI	MU-GDID13	51304728-100	51304728-125
GI 24 Vdc DI	MU-GDID82	51304640-300	51304640-325
GI 24 Vdc DI	MU-GDID83	51304728-300	51304728-325

Continued on next page

7.5 FTAs, Continued

Nonconformally coated FTAs, continued

Table 7-4 Field Termination Assemblies—Nonconformally Coated, Continued

FTA Type	Model Number	Non-CE Compliant Part Number	CE Compliant Part Number
GI 24 Vdc DO	MU-GDOD12	51304642-100	51304642-125
GI 24 Vdc DO	MU-GDOD82	51304642-300	51304642-325
GI DO with LFD	MU-GDOL12	51304736-100	51304736-125
GI DO with LFD	MU-GDOL82	51304736-300	51304736-325
GI Combiner Panel	MU-GLFD02	51304732-100	51304732-125
GI Marshalling Panel	MU-GMAR52	51304646-100	51309156-125

Continued on next page

7.5 FTAs, Continued

Conformally coated FTAs

Table 7-5 is a list of CE Compliant and non-CE Compliant FTAs that are conformally coated. Model numbers and part numbers identify the assemblies.

Table 7-5 Field Termination Assemblies—Conformally Coated

FTA Type	Model Number	Non-CE Compliant Part Number	CE Compliant Part Number
LLAI	MC-TAIL02	51304437-150	N/A
LLAI	MC-TAIL03	N/A	51309202-175
LLMux RTD	MC-TAMR02	51304477-150	N/A
LLMux RTD	MC-TAMR03	N/A	51309218-175
LLMux TC	MC-TAMT02	51401491-150	N/A
LLMux TC	MC-TAMT03	N/A	51309223-175
LLMux TC Remote	MC-TAMT12	51401573-150	N/A
LLMux TC Remote	MC-TAMT13	N/A	51309213-175
RHMUX TC Local CJR	MC-GRMT01	N/A	51404106-175
RHMUX GI/IS Power Adapter	MC-GRPA01	N/A	51304724-175
RHMUX GI/NI Power Adapter	MC-TRPA01	N/A	51304722-175
HLAI/STI	MC-TAIH02	51304453-150	N/A
HLAI/STI	MC-TAIH12	51304337-150	N/A
HLAI/STI	MU-TAIH22	80366195-150	N/A
HLAI/STI	MU-TAIH52	51304337-250	N/A
HLAI/STI	MU-TAIH62	80366192-150	N/A
HLAI	MC-TAIH03	N/A	51309136-175
HLAI	MC-TAIH13	N/A	51309138-175
HLAI	MU-TAIH23	N/A	80369165-175
HLAI	MC-TAIH53	N/A	51309138-275
STI	MC-TSTX03	N/A	51309136-175
STI	MC-TSTX13	N/A	51309138-175
STI	MC-TSTX53	N/A	51309138-275

Continued on next page