

Controls and Power Electronics

ED.04

For industrial applications



GE imagination at work

POWER DEVICES

Contactors and overload relays

Intro

A

Auxiliary relays and contactors

B

Motor protection devices

C

Applications

D

Main switches

E

AUXILIARY DEVICES

Control and signalling units

F

Electronic relays and limit switches

G

POWER ELECTRONICS

Speed drive units

H

Soft starters

I

Lighting dimmer-stabilizer/Numerical index

J/X



A

Contactor and thermal overload relays

Efficor - Global contactors



Compact starter either with thermal overload relay or manual motor starter.

● A.2

Series EA - Minicontactors



Three pole minicontactors
7A (AC3)
16A (AC1)

● A.42

Series M - Contactors



3 and 4P (4NO, 2NO+2NC, 4NC)
6, 9 and 12A (AC-3)
20A (AC-1) Control circuit AC
and DC

● A.44

Series CL - Contactors



3 and 4P (4NO, 2NO+2NC) 9 to
105A (AC-3) 25 to 140A
(AC-1) AC, DC and with electronic
module

● A.52

Series CK - Contactors



3 and 4P (4NO) 150 to 825A (AC-3)
200 to 1250A (AC-1)
AC, DC and with electronic module

● A.62

Series MTO - Thermal overload relays



For minicontactors series M from
0.11 to 14A

● A.68

Series RT - Thermal overload relays



For contactors series CL and CK
from 0.16 to 850A
Class 10A, 10, 20, 30

● A.70

Series RE - Electronic overload relays



For contactors series CL from
0.1 to 150A

● A.74

EntelliPro



Intelligent motor management
relay

● A.76

Series CSCN - Contactors for capacitor switching



● A.144

Series 390.R - Clapper contactors

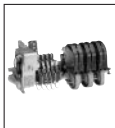

40A to 800A (AC-3)
45A to 1200A (AC-1)

● A.150

B

Plug-in relays and auxiliary contactors

Series PRC - Plug-in relays



Miniature plug-in relays
Standard 8-11 pin plug-in relays
Interface relay

● B.2

Series M - Auxiliary contactors

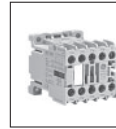

I_{th} = 16A

● B.8

Series RL - Auxiliary contactors



I_{th} = 20A

● B.14

C

Motor protection devices

Surion - Manual motor starter



Thermal and magnetic protection -
Magnetic protection only
Setting ranges from 0.1 to 63A

● C.2

Series SFK - Motor protection circuit breaker



Thermal and magnetic protection
of AC and DC motors
Setting ranges from 0.1 to 25A

● C.32

D

Applications

Technical data

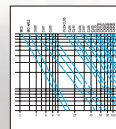

Utilization categories
Electrical endurance
Machine directive -
B10d value for contactors

● D.3-D.8

Selection tables / Dimensional drawings / Wiring diagrams

● D.9-D.48

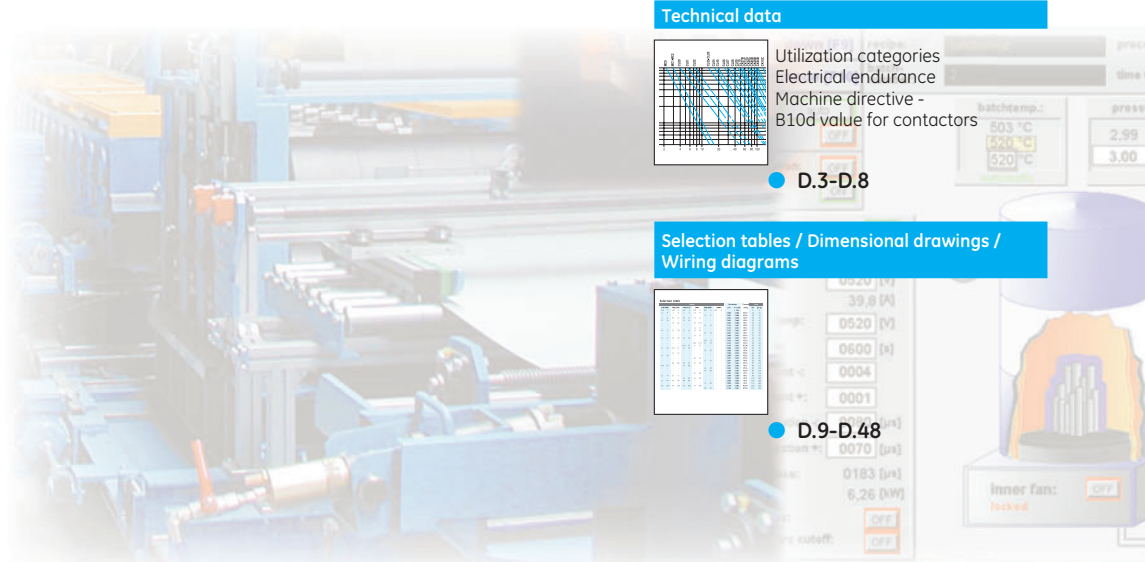

E

Main switches

Series ML



Standard programme
Main switches and emergency-stop switches for machinery

enclosed switches

● E.4

Switches for photovoltaic applications



To isolate the solar panels from the inverter, from 16 to 100Adc

● E.13

F

Control and signalling units

Series P9 - Panel mounting - Units Ø 22 mm



● F.8

Series P9 - Base mounting



● F.23

Series P9 - Push-button stations / Equipped boxes



● F.24-F.25

Series P9 - Common accessories



● F.30

Series 077 - Units Ø 30 mm



● F.42

Series 105 - Signalling devices



● F.57

G

Electronic relays and limit switches

Series NMV - Multivoltage relays



22.5mm module
Direct supply voltage (24-240V AC/DC)
With transformer

● G.2

Series D - Single voltage electronic timers



45mm module
Direct supply voltage

● G.3

Limit switches



Series IS and IM
Metal and thermoplastic limit switches
Series IUG
Thermoplastic limit switches
Series IZ
Miniature thermoplastic limit switches
Series 114FCT
Three pole limit switches

● G.22

Pressure switches



Series 115

● G.36

H

Speed drive units

VAT20



Single-phase or three-phase digital inverters for controlling the speed of three-phase induction AC motors from 0.2 to 2.2 kW IP20 or IP65

● H.2

VAT200



From 0.4 to 2.2kW at 200V, single phase power supply
From 0.4 to 7.5kW at 200V, three phase power supply
From 0.75 to 11kW at 400V, three phase power supply

● H.8

AF6 drives



Drives designed for general purpose applications

● H.18

I

Softstarters

ASTAT S - Soft starter



Small soft starter with integral by-pass

● I.3

ASTAT XT - Digital soft starter



Digital soft starter for 3 phase standard induction motors

● I.8



Visit www.ge.com/ex/industrialsolutions and click on

Minicontactors Series M (6A - 12A - AC3)

Refine Your Results — 715 products match your selections.

Series:

Control circuit: All AC DC DC WIDE VOLTAGE RANGE

Frequency Control Voltage: AC All 50 Hz 50 Hz / 60 Hz 60 Hz

Control Voltage: AC

Control Voltage: AC Bifreq. Coil (at 50-60 Hz)

Control Voltage: DC

Control Voltage: DC - Wide Voltage Range

Terminal: All Faston 2x2.8 Faston 2x2.8 insulated Printed circuit Ring Terminal Capability Screw terminal Spare coil

- All product info available in one central place
- All product info is available to download, print or e-mail
- Always the latest up-to-date info

e-Catalogue

Search Parameters: e-Catalogue > Control and automation > Contactors and overload relays > Minicontactors Series M (6A - 12A - AC3) > Series: Three-pole contactors 6, 9 and 12 A (AC3) Products 1-25 of 333

333 products match your selections Sort by: Product# Display 25 products per page

up to 4 items

Product#	Catalogue#	Description
100037	MC0A310AFC	Faston 2x2.8 insulated 3P, AC3 2.2kW, 24V/60Hz AC, 1NO
100147	MC0A310AM	Printed circuit 3P, AC3 2.2kW, 208-220V/60Hz AC, 1NO
100150	MC0C310ATB	Screw terminal 3P, AC3 2.2kW, 12V DC, 1NO
100151	MC0A310ATD	Screw terminal 3P, AC3 2.2kW, 24V/50Hz AC, 1NO
100152	MC0A310ATG	Screw terminal 3P, AC3 2.2kW, 48V/50Hz/60V/60Hz AC, 1NO
100153	MC0A310ATJ	Screw terminal 3P, AC3 2.2kW, 110V/50Hz/120V/60Hz AC, 1NO
100154	MC0A310ATN	Screw terminal 3P, AC3 2.2kW, 220-240V/50Hz/240-277V/60Hz AC, 1NO

- Use the **Quick-search** using a **part number** or **keyword**
- Find a product by using the **parametric search**, simply enter the technical characteristics you are looking for
- **Compare** up to 4 products and view the technical data and accessories on a single page
- **High resolution images** are available by clicking on the small product image
- Product pages contain all available data: **technical specifications, dimensional and CAD drawings, product descriptions**, ...
- The data also displays the **available functions and accessories** for each product

e-Catalogue

Search Parameters: e-Catalogue > Control and automation > Contactors and overload relays > Minicontactors Series M (6A - 12A - AC3) > Series: Three-pole contactors 6, 9 and 12 A (AC3)

Minicontactors Series M (6A - 12A - AC3)

Product#: 100152 Catalogue#: MC0A310ATG

Screw terminal 3P, AC3 2.2kW, 48V/50Hz/60V/60Hz AC, 1NO

SPECIFICATIONS	
Series	Three-pole contactors 6, 9 and 12 A (AC3)
Control circuit	AC
Frequency Control Voltage: AC	60 Hz
Control Voltage: AC	48 V (50 Hz) / 60 V (60 Hz)
Terminal	Screw terminal
Non-inductive load AC1	20 A
Aux Contacts	1NO
Admissible Power AC3 1-Phase 115V	0.37 kW
Admissible Power AC3 1-Phase 220V, 230V	0.75 kW
Admissible Power AC3 3-Phase 220V, 230V	1.5 kW
Admissible Power AC3 3-Phase 380V, 400V	2.2 kW
Admissible Power AC3 3-Phase 500V	3 kW
Package (pcs)	20
EAN13	8425095001527
DIMENSIONS	
Weight	0.17 kg

Dimensions
[More info on website](#)
[Overview + order details](#)
[Technical data](#)

- Control circuit: Alternating current up to 600V Direct current up to 250V
- Terminal numbering in accordance with EN 50012
- Fixing by clipping onto 35mm DIN rail (EN 50022) or by screws

High resolution images available

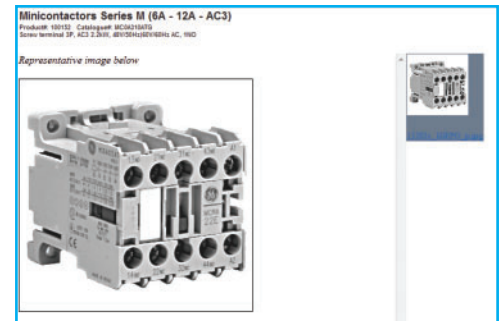

Order codes

- A.2 New **Efficor** global contactors
- A.42 **Series EA** - Three pole minicontactors
- A.44 **Series M** - Three and four pole contactors
- A.52 **Series CL** - Three and four pole contactors
- A.62 **Series CK** - Three and four pole contactors
- A.68 **Series MTO** - Thermal overload relays
- A.70 **Series RT** - Thermal overload relays
- A.74 **Series RE** - Electronic overload relay
- A.76 **EntelliPro** - Intelligent motor management relay
- A.144 **Series CSCN** - Contactors for capacitors switching
- A.150 **Series 390.R** - Clapper contactors

POWER DEVICES

Contactors and overload relays

Technical data

- A.83 Series M
- A.91 Series CL
- A.102 Series CK
- A.120 Series MTO
- A.122 Series RT
- A.128 Series RE

Dimensional drawings

- A.110 Series M
- A.112 Series CL
- A.118 Series CK
- A.121 Series MTO
- A.126 Series RT
- A.130 Series RE

Wiring diagrams

- A.131 Series M
- A.132 Series CL
- A.133 Series CK

Auxiliary relays and contactors

Motor protection devices

Applications

Main switches

AUXILIARY DEVICES

Control and signalling units

Electronic relays and limit switches

POWER ELECTRONICS

Speed drive units

Soft starters

Lighting dimmer-stabilizer/Numerical index

Intro

A

B

C

D

E

F

G

H

I

J/X



Most reliable technology

- Standard materials for food & beverage and transportation purposes ... complying the latest rail standards
- Highest reliable product performance for worldwide applications
- Energy efficient design ... ecological mindset

Best electrical endurance

Electrical endurance > 1.7 million operations
AC3 category at rated current

Reliability data per standard EN ISO 13849-1

EC09-12	2x10 ⁶ ops
EC18-25	1.7x10 ⁶ ops
EC32-40	1.37x10 ⁶ ops

Widest temperature operation

from -40°C to +55°C
Suitable for extreme temperatures

Reduced flammability risk and lower toxicity

For demanding applications as lifts, appliances and transportation

Lowest noise production: 32dBA

Perfect answer to demanding applications like hospitals

Compliant with International standards for plastic parts

NF 16-101 & NF 16-102
DIN 5510.2
Safe ecological plastic for all applications

Only one frame covering 9 up to 40A series

Three different depths

- Depth 1: 9A up to 18A
- Depth 2: 25A
- Depth 3: 32A up to 40A



High installation benefits

- Smart, various wiring and connectivity technologies ... fast assembly of starter solutions
- Smaller product dimensions for panel design and motor control centers ... integrated auxiliary contacts in standard product
- Modular and compact motor starter solutions

Best in class

- Highest B10d data as per ISO.13849-1
- Optimized power per size
- Lower number of stock keeping units ... reducing stock complexity for distributors, panelbuilders and OEM customers
- Outstanding range of power contactors and motor starter solutions ... including wide range of accessories

Standards

- IEC/EN 60947-1
- IEC/EN 60947-4-1
- IEC/EN 60947-5-1
- EN 50005
- UL 508
- CSA 22.2/14
- VDE 0660/102

Approvals

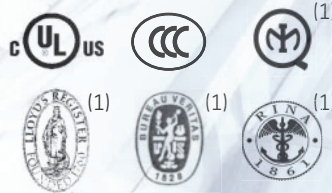

(1) In progress

pro



A new dimension

Compact starter

Significant space reduction in the cabinet: Compact starter either with thermal overload relay or manual motor starter.

Starter mounting plates for friendly maintenance (easy removal of MMS Surion and/or contactor).

Busbar systems and wiring kits allow safe cabling avoiding mistakes, guaranteeing finger safe protection up to 6kV.

Contactor with manual motor starter

Link module for compact starter

Full coil access at the bottom

Contactor with thermal overload relay

Uniformity in compact design

Thermal overload relay mounted direct to the contactor.

All connections available



Even efficient



in global contactors

efficor™

Benefits

Intro

A

B

C

D

E

F

G

H

I

J/X



New

Secure connection

Smart connectivity

- Design of intelligent base plate

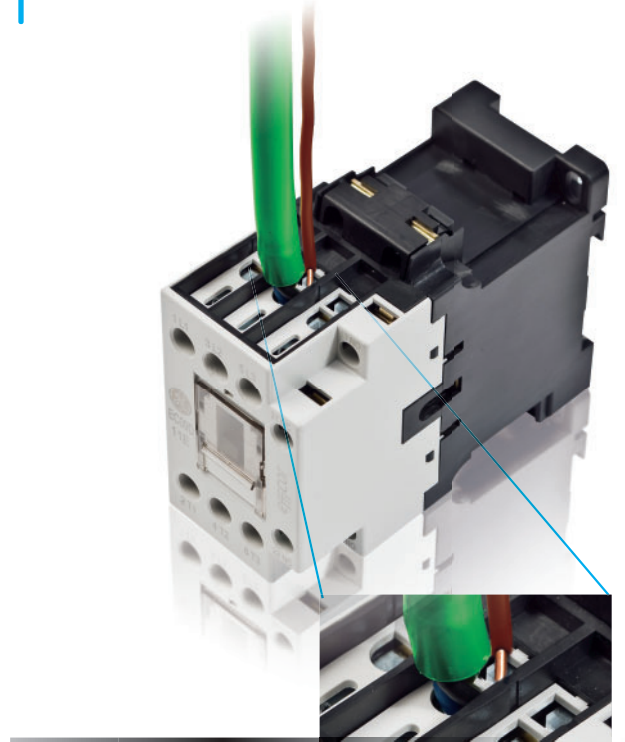
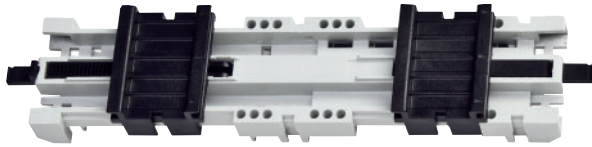

Global contactors

Intro

A

B

C

D

E

F

G

H

I

J/X

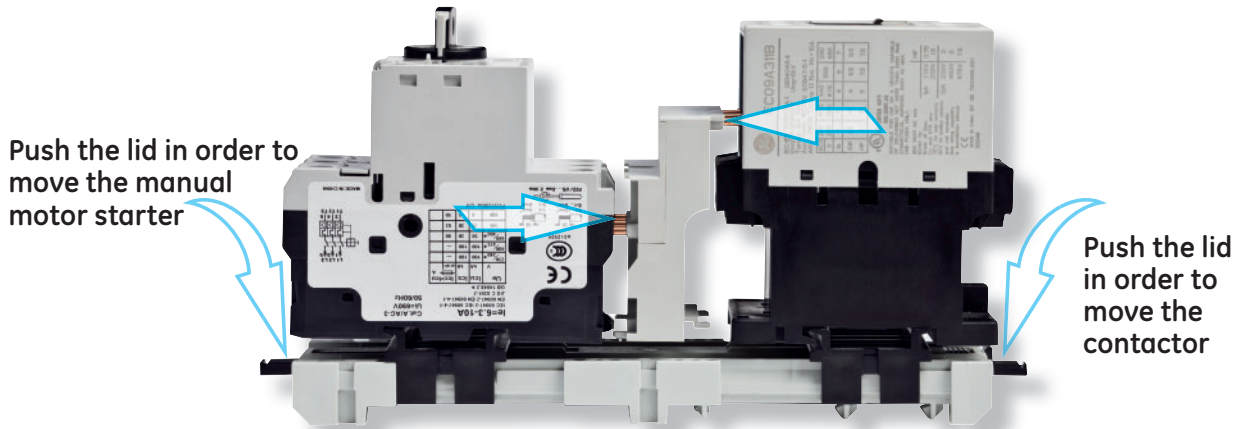

New



Time saving

Main advantages

Double box terminals

Identical torque (2.2 Nm) for 9A up to 40A contactors.
No need for different screwdrivers.

- Double box clamps for the whole range
- Cables from 0.75mm² up to 16mm² in the same box clamps terminal for 4kW up to 18.5kW.
- No risk for loosing cables
- Avoid temperature rising on the small cable

No tools needed

Mounting or dismounting the contactors on/from the DIN-rail can be done without tools.
Even for the mounting of accessories and auxiliaries to the contactor no tools are required.

Quick assembly of direct online starter

- User friendly design of link modules and base plates to combine manual motor starter and contactor.
- Smart busbar systems and wiring kits.

Easy identification

Self explanatory description of the catalogue number is an important advantage

Example: EC 09 A 3 11 B 230

- EC:** Means Efficor Contactor range
- 09:** 9A in AC3 application
- A:** Type of control voltage
 - A stands for AC
 - D stands for DC
- 3:** Number of main poles
 - 3 stands for 3 poles
 - 4 stands for 4 poles
 - B stands for 2NO + 2NC
- 11:** Number of auxiliary contacts built-in 1NO and 1NC
- B:** Type of terminal
 - B stands for Box terminal
 - R stands for Ring terminal
- 230:** Coil voltage
- W:** End character for DC contactors
 - W stands for Wide voltage and built-in diode
 - L stands for Low consumption

- Time saving
- Space saving
- Stock saving
- Secure connection
- Energy efficiency design
- Reliable technology
- Smart connecting



Benefits

Intro

A

B

C

D

E

F

G

H

I

J/X

New



3 pole contactors - Double box terminals

Global contactors

Max. operating current		Admissible power AC3				Electrical endurance	Aux. cont.	Control circuit														
Not inductive load AC1 A	Motors <440V 3Ph 50/60Hz AC3 A	220-230V	380-400V	440V	500V	Cat. AC3 Operations	NO NC	AC			DC			Pack								
		kW HP	kW HP	kW HP	kW HP			Voltage	Cat. no.	Ref. no.	Voltage	Cat. no. ⁽¹⁾	Ref. no.									
25	9	2.2 3	4 5.5	4 5.5	5.5 7.5	1.7x10 ⁶	1 1	12	EC09A311B012	267001	12	EC09D311B012W	267085	5								
								24	EC09A311B024	267002	24	EC09D311B024W	267086	5								
								42	EC09A311B042	267003	36	EC09D311B036W	267087	5								
								48	EC09A311B048	267004	48	EC09D311B048W	267088	5								
								110	EC09A311B110	267005	60	EC09D311B060W	267089	5								
								120	EC09A311B120	267006	72	EC09D311B072W	267090	5								
								208	EC09A311B208	267007	110	EC09D311B110W	267091	5								
								230	EC09A311B230	267008	125	EC09D311B125W	267092	5								
								240	EC09A311B240	267009	230	EC09D311B230W	267093	5								
								400	EC09A311B400	267010	250	EC09D311B250W	267094	5								
								440	EC09A311B440	267011	440	EC09D311B440W	267095	5								
								480	EC09A311B480	267012	24	EC09D311B024L	267096	5								
								500	EC09A311B500	267013	48	EC09D311B048L	267097	5								
								575	EC09A311B575	269075	110	EC09D311B110L	267098	5								
								600	EC09A311B600	267014	230	EC09D311B230L	267099	5								
								25	12	3 4	5.5 7.5	5.5 7.5	7.5 10	1.7x10 ⁶	1 1	12	EC12A311B012	267015	12	EC12D311B012W	267100	5
																24	EC12A311B024	267016	24	EC12D311B024W	267101	5
																42	EC12A311B042	267017	36	EC12D311B036W	267102	5
48	EC12A311B048	267018	48	EC12D311B048W	267103	5																
110	EC12A311B110	267019	60	EC12D311B060W	267104	5																
120	EC12A311B120	267020	72	EC12D311B072W	267105	5																
208	EC12A311B208	267021	110	EC12D311B110W	267106	5																
230	EC12A311B230	267022	125	EC12D311B125W	267107	5																
240	EC12A311B240	267023	230	EC12D311B230W	267108	5																
400	EC12A311B400	267024	250	EC12D311B250W	267109	5																
440	EC12A311B440	267025	440	EC12D311B440W	267110	5																
480	EC12A311B480	267026	24	EC12D311B024L	267111	5																
500	EC12A311B500	267027	48	EC12D311B048L	267112	5																
575	EC12A311B575	269076	110	EC12D311B110L	267113	5																
600	EC12A311B600	267028	230	EC12D311B230L	267114	5																
32	18	4 5.5	7.5 10	7.5 10	10 13.5	1.7x10 ⁶	1 1									12	EC18A311B012	267029	12	EC18D311B012W	267115	5
																24	EC18A311B024	267030	24	EC18D311B024W	267116	5
																42	EC18A311B042	267031	36	EC18D311B036W	267117	5
								48	EC18A311B048	267032	48	EC18D311B048W	267118	5								
								110	EC18A311B110	267033	60	EC18D311B060W	267119	5								
								120	EC18A311B120	267034	72	EC18D311B072W	267120	5								
								208	EC18A311B208	267035	110	EC18D311B110W	267121	5								
								230	EC18A311B230	267036	125	EC18D311B125W	267122	5								
								240	EC18A311B240	267037	230	EC18D311B230W	267123	5								
								400	EC18A311B400	267038	250	EC18D311B250W	267124	5								
								440	EC18A311B440	267039	440	EC18D311B440W	267125	5								
								480	EC18A311B480	267040	24	EC18D311B024L	267126	5								
								500	EC18A311B500	267041	48	EC18D311B048L	267127	5								
								575	EC18A311B575	269077	110	EC18D311B110L	267128	5								
								600	EC18A311B600	267042	230	EC18D311B230L	267129	5								
								45	25	7.5 10	11 15	12 16	15 20	1.5x10 ⁶	1 1	12	EC25A311B012	267043	12	EC25D311B012W	267130	1
																24	EC25A311B024	267044	24	EC25D311B024W	267131	1
																42	EC25A311B042	267045	36	EC25D311B036W	267132	1
48	EC25A311B048	267046	48	EC25D311B048W	267133	1																
110	EC25A311B110	267047	60	EC25D311B060W	267134	1																
120	EC25A311B120	267048	72	EC25D311B072W	267135	1																
208	EC25A311B208	267049	110	EC25D311B110W	267136	1																
230	EC25A311B230	267050	125	EC25D311B125W	267137	1																
240	EC25A311B240	267051	230	EC25D311B230W	267138	1																
400	EC25A311B400	267052	250	EC25D311B250W	267139	1																
440	EC25A311B440	267053	440	EC25D311B440W	267140	1																
480	EC25A311B480	267054	24	EC25D311B024L	267141	1																
500	EC25A311B500	267055	48	EC25D311B048L	267142	1																
575	EC25A311B575	269078	110	EC25D311B110L	267143	1																
600	EC25A311B600	267056	230	EC25D311B230L	267144	1																
60	32	9 12	15 22	15 22	18 25	1.5x10 ⁶	0 0									12	EC32A300B012	267057	12	EC32D300B012W	267145	1
																24	EC32A300B024	267058	24	EC32D300B024W	267146	1
																42	EC32A300B042	267059	36	EC32D300B036W	267147	1
								48	EC32A300B048	267060	48	EC32D300B048W	267148	1								
								110	EC32A300B110	267061	60	EC32D300B060W	267149	1								
								120	EC32A300B120	267062	72	EC32D300B072W	267150	1								
								208	EC32A300B208	267063	110	EC32D300B110W	267151	1								
								230	EC32A300B230	267064	125	EC32D300B125W	267152	1								
								240	EC32A300B240	267065	230	EC32D300B230W	267153	1								
								400	EC32A300B400	267066	250	EC32D300B250W	267154	1								
								440	EC32A300B440	267067	440	EC32D300B440W	267155	1								
								480	EC32A300B480	267068	24	EC32D300B024L	267156	1								
								500	EC32A300B500	267069	48	EC32D300B048L	267157	1								
								575	EC32A300B575	269079	110	EC32D300B110L	267158	1								
								600	EC32A300B600	267070	230	EC32D300B230L	267159	1								
								60	40	11 15	18.5 25	22 30	25 34	1.5x10 ⁶	0 0	12	EC40A300B012	267071	12	EC40D300B012W	267160	1
																24	EC40A300B024	267072	24	EC40D300B024W	267161	1
																42	EC40A300B042	267073	36	EC40D300B036W	267162	1
48	EC40A300B048	267074	48	EC40D300B048W	267163	1																
110	EC40A300B110	267075	60	EC40D300B060W	267164	1																
120	EC40A300B120	267076	72	EC40D300B072W	267165	1																
208	EC40A300B208	267077	110	EC40D300B110W	267166	1																
230	EC40A300B230	267078	125	EC40D300B125W	267167	1																
240	EC40A300B240	267079	230	EC40D300B230W	267168	1																
400	EC40A300B400	267080	250	EC40D300B250W	267169	1																
440	EC40A300B440	267081	440	EC40D300B440W	267170	1																
480	EC40A300B480	267082	24	EC40D300B024L	267171	1																
500	EC40A300B500	267083	48	EC40D300B048L	267172	1																
575	EC40A300B575	269080	110	EC40D300B110L	267173	1																
600	EC40A300B600	267084	230	EC40D300B230L	267174	1																



(1) End character: W = Wide voltage and built-in diode
L = Low consumption



New

4 pole contactors - Double box terminals

Max. operating current		Admissible power AC1				Electrical endurance	Power cont.	Control circuit							
Not inductive load AC1 A	Motors <440V 3Ph 50/60Hz AC3 A	220-230V kW	380-400V kW	440V kW	500V kW	Cat. AC1 Operations	NO	NC	AC			DC			Pack
									Voltage	Cat. no.	Ref. no.	Voltage	Cat. no. ^[1]	Ref. no.	
25	12	9.5	16.5	18	21.5	4x10 ⁵	4	0	12	EC12A400B012	267175	12	EC12D400B012W	267231	5
									24	EC12A400B024	267176	24	EC12D400B024W	267232	5
									42	EC12A400B042	267177	36	EC12D400B036W	267233	5
									48	EC12A400B048	267178	48	EC12D400B048W	267234	5
									110	EC12A400B110	267179	60	EC12D400B060W	267235	5
									120	EC12A400B120	267180	72	EC12D400B072W	267236	5
									208	EC12A400B208	267181	110	EC12D400B110W	267237	5
									230	EC12A400B230	267182	125	EC12D400B125W	267238	5
									240	EC12A400B240	267183	230	EC12D400B230W	267239	5
									400	EC12A400B400	267184	250	EC12D400B250W	267240	5
									440	EC12A400B440	267185	440	EC12D400B440W	267241	5
									480	EC12A400B480	267186				
									500	EC12A400B500	267187	24	EC12D400B024L	267242	5
									575	EC12A400B575	269081	48	EC12D400B048L	267243	5
									600	EC12A400B600	267188	110	EC12D400B110L	267244	5
												230	EC12D400B230L	267245	5
32	18	12	22	23	27.5	6x10 ⁵	4	0	12	EC18A400B012	267189	12	EC18D400B012W	267246	5
									24	EC18A400B024	267190	24	EC18D400B024W	267247	5
									42	EC18A400B042	267191	36	EC18D400B036W	267248	5
									48	EC18A400B048	267192	48	EC18D400B048W	267249	5
									110	EC18A400B110	267193	60	EC18D400B060W	267250	5
									120	EC18A400B120	267194	72	EC18D400B072W	267251	5
									208	EC18A400B208	267195	110	EC18D400B110W	267252	5
									230	EC18A400B230	267196	125	EC18D400B125W	267253	5
									240	EC18A400B240	267197	230	EC18D400B230W	267254	5
									400	EC18A400B400	267198	250	EC18D400B250W	267255	5
									440	EC18A400B440	267199	440	EC18D400B440W	267256	5
									480	EC18A400B480	267200				
									500	EC18A400B500	267201	24	EC18D400B024L	267257	5
									575	EC18A400B575	269082	48	EC18D400B048L	267258	5
									600	EC18A400B600	267202	110	EC18D400B110L	267259	5
												230	EC18D400B230L	267260	5
45	25	17	29	32	39	6.5x10 ⁵	4	0	12	EC25A400B012	267203	12	EC25D400B012W	267261	5
									24	EC25A400B024	267204	24	EC25D400B024W	267262	5
									42	EC25A400B042	267205	36	EC25D400B036W	267263	5
									48	EC25A400B048	267206	48	EC25D400B048W	267264	5
									110	EC25A400B110	267207	60	EC25D400B060W	267265	5
									120	EC25A400B120	267208	72	EC25D400B072W	267266	5
									208	EC25A400B208	267209	110	EC25D400B110W	267267	5
									230	EC25A400B230	267210	125	EC25D400B125W	267268	5
									240	EC25A400B240	267211	230	EC25D400B230W	267269	5
									400	EC25A400B400	267212	250	EC25D400B250W	267270	5
									440	EC25A400B440	267213	440	EC25D400B440W	267271	5
									480	EC25A400B480	267214				
									500	EC25A400B500	267215	24	EC25D400B024L	267272	5
									575	EC25A400B575	269083	48	EC25D400B048L	267273	5
									600	EC25A400B600	267216	110	EC25D400B110L	267274	5
												230	EC25D400B230L	267275	5
60	32	22.5	39.5	43	52	8x10 ⁵	4	0	12	EC32A400B012	267217	12	EC32D400B012W	267276	1
									24	EC32A400B024	267218	24	EC32D400B024W	267277	1
									42	EC32A400B042	267219	36	EC32D400B036W	267278	1
									48	EC32A400B048	267220	48	EC32D400B048W	267279	1
									110	EC32A400B110	267221	60	EC32D400B060W	267280	1
									120	EC32A400B120	267222	72	EC32D400B072W	267281	1
									208	EC32A400B208	267223	110	EC32D400B110W	267282	1
									230	EC32A400B230	267224	125	EC32D400B125W	267283	1
									240	EC32A400B240	267225	230	EC32D400B230W	267284	1
									400	EC32A400B400	267226	250	EC32D400B250W	267285	1
									440	EC32A400B440	267227	440	EC32D400B440W	267286	1
									480	EC32A400B480	267228				
									500	EC32A400B500	267229	24	EC32D400B024L	267287	1
									575	EC32A400B575	269084	48	EC32D400B048L	267288	1
									600	EC32A400B600	267230	110	EC32D400B110L	267289	1
												230	EC32D400B230L	267290	1

(1) End character: W = Wide voltage and built-in diode
L = Low consumption



New

Order codes

Intro

A

B

C

D

E

F

G





H

I

J/X

2NO - 2NC contactors - Double box terminals

Global contactors

Max. operating current		Admissible power AC3				Electrical endurance	Power cont.	Control circuit							
Not inductive load AC1 A	Motors <440V 3Ph 50/60Hz AC3 A	220-230V	380-400V	440V	500V	Cat. AC3 Operations	NO NC	AC			DC			Pack	
		kW HP	kW HP	kW HP	kW HP			Voltage	Cat. no.	Ref. no.	Voltage	Cat. no. ⁽¹⁾	Ref. no.		
25	12	3	5.5	5.5	7.5	1.7x10 ⁶	2	2	12	EC12AB00B012	267291	12	EC12DB00B012W	267347	5
			4	7.5	7.5		10	2	2	24	EC12AB00B024	267292	24	EC12DB00B024W	267348
			2	2	42		EC12AB00B042	267293	36	EC12DB00B036W	267349	5			
			2	2	48		EC12AB00B048	267294	48	EC12DB00B048W	267350	5			
			2	2	110		EC12AB00B110	267295	60	EC12DB00B060W	267351	5			
			2	2	120		EC12AB00B120	267296	72	EC12DB00B072W	267352	5			
			2	2	208		EC12AB00B208	267297	110	EC12DB00B110W	267353	5			
			2	2	230		EC12AB00B230	267298	125	EC12DB00B125W	267354	5			
			2	2	240		EC12AB00B240	267299	230	EC12DB00B230W	267355	5			
			2	2	400		EC12AB00B400	267300	250	EC12DB00B250W	267356	5			
			2	2	440		EC12AB00B440	267301	440	EC12DB00B440W	267357	5			
			2	2	480		EC12AB00B480	267302							
			2	2	500		EC12AB00B500	267303	24	EC12DB00B024L	267358	5			
			2	2	575		EC12AB00B575	269115	48	EC12DB00B048L	267359	5			
			2	2	600		EC12AB00B600	267304	110	EC12DB00B110L	267360	5			
			2	2					230	EC12DB00B230L	267361	5			
32	18	4	7.5	7.5	10	1.5x10 ⁶	2	2	12	EC18AB00B012	267305	12	EC18DB00B012W	267362	5
			5.5	10	13.5		2	2	24	EC18AB00B024	267306	24	EC18DB00B024W	267363	5
			2	2	42		EC18AB00B042	267307	36	EC18DB00B036W	267364	5			
			2	2	48		EC18AB00B048	267308	48	EC18DB00B048W	267365	5			
			2	2	110		EC18AB00B110	267309	60	EC18DB00B060W	267366	5			
			2	2	120		EC18AB00B120	267310	72	EC18DB00B072W	267367	5			
			2	2	208		EC18AB00B208	267311	110	EC18DB00B110W	267368	5			
			2	2	230		EC18AB00B230	267312	125	EC18DB00B125W	267369	5			
			2	2	240		EC18AB00B240	267313	230	EC18DB00B230W	267370	5			
			2	2	400		EC18AB00B400	267314	250	EC18DB00B250W	267371	5			
			2	2	440		EC18AB00B440	267315	440	EC18DB00B440W	267372	5			
			2	2	480		EC18AB00B480	267316							
			2	2	500		EC18AB00B500	267317	24	EC18DB00B024L	267373	5			
			2	2	575		EC18AB00B575	269116	48	EC18DB00B048L	267374	5			
			2	2	600		EC18AB00B600	267318	110	EC18DB00B110L	267375	5			
			2	2					230	EC18DB00B230L	267376	5			
45	25	7.5	11	12	15	1.5x10 ⁶	2	2	12	EC25AB00B012	267319	12	EC25DB00B012W	267377	5
			10	15	16		20	2	2	24	EC25AB00B024	267320	24	EC25DB00B024W	267378
			2	2	42		EC25AB00B042	267321	36	EC25DB00B036W	267379	5			
			2	2	48		EC25AB00B048	267322	48	EC25DB00B048W	267380	5			
			2	2	110		EC25AB00B110	267323	60	EC25DB00B060W	267381	5			
			2	2	120		EC25AB00B120	267324	72	EC25DB00B072W	267382	5			
			2	2	208		EC25AB00B208	267325	110	EC25DB00B110W	267383	5			
			2	2	230		EC25AB00B230	267326	125	EC25DB00B125W	267384	5			
			2	2	240		EC25AB00B240	267327	230	EC25DB00B230W	267385	5			
			2	2	400		EC25AB00B400	267328	250	EC25DB00B250W	267386	5			
			2	2	440		EC25AB00B440	267329	440	EC25DB00B440W	267387	5			
			2	2	480		EC25AB00B480	267330							
			2	2	500		EC25AB00B500	267331							
			2	2	575		EC25AB00B575	269117							
			2	2	600		EC25AB00B600	267332							
			60	32	9		15	15	18	1.5x10 ⁶	2	2	12	EC32AB00B012	267333
12	22	22				25	2	2	24		EC32AB00B024	267334	24	EC32DB00B024W	267393
	2	2			42	EC32AB00B042	267335	36	EC32DB00B036W		267394	1			
	2	2			48	EC32AB00B048	267336	48	EC32DB00B048W		267395	1			
	2	2			110	EC32AB00B110	267337	60	EC32DB00B060W		267396	1			
	2	2			120	EC32AB00B120	267338	72	EC32DB00B072W		267397	1			
	2	2			208	EC32AB00B208	267339	110	EC32DB00B110W		267398	1			
	2	2			230	EC32AB00B230	267340	125	EC32DB00B125W		267399	1			
	2	2			240	EC32AB00B240	267341	230	EC32DB00B230W		267400	1			
	2	2			400	EC32AB00B400	267342	250	EC32DB00B250W		267401	1			
	2	2			440	EC32AB00B440	267343	440	EC32DB00B440W		267402	1			
	2	2			480	EC32AB00B480	267344								
	2	2			500	EC32AB00B500	267345								
	2	2			575	EC32AB00B575	269118								
	2	2			600	EC32AB00B600	267346								

(1) End character: W = Wide voltage and built-in diode
L = Low consumption



New

Auxiliary contactors - Double box terminals - Ith 20A



Contacts		Control circuit						
NO 3 4	NC 1 2	AC			DC			Pack
		Voltage	Cat. no.	Ref. no.	Voltage	Cat. no. ^[1]	Ref. no.	
4	0	12	ECACA440B012	268140	12	ECACD440B012W	268210	5
4	0	24	ECACA440B024	268141	24	ECACD440B024W	268211	5
4	0	42	ECACA440B042	268142	36	ECACD440B036W	268212	5
4	0	48	ECACA440B048	268143	48	ECACD440B048W	268213	5
4	0	110	ECACA440B110	268144	60	ECACD440B060W	268214	5
4	0	120	ECACA440B120	268145	72	ECACD440B072W	268215	5
4	0	208	ECACA440B208	268146	110	ECACD440B110W	268216	5
4	0	230	ECACA440B230	268147	125	ECACD440B125W	268217	5
4	0	240	ECACA440B240	268148	230	ECACD440B230W	268218	5
4	0	400	ECACA440B400	268149	250	ECACD440B250W	268219	5
4	0	440	ECACA440B440	268150	400	ECACD440B440W	268220	5
4	0	480	ECACA440B480	268151				
4	0	500	ECACA440B500	268152	24	ECACD440B024L	268221	5
4	0	575	ECACA440B575	268673	48	ECACD440B048L	268222	5
4	0	600	ECACA440B600	268153	110	ECACD440B110L	268223	5
4	0				230	ECACD440B230L	268224	5
3	1	12	ECACA431B012	268154	12	ECACD431B012W	268225	5
3	1	24	ECACA431B024	268155	24	ECACD431B024W	268226	5
3	1	42	ECACA431B042	268156	36	ECACD431B036W	268227	5
3	1	48	ECACA431B048	268157	48	ECACD431B048W	268228	5
3	1	110	ECACA431B110	268158	60	ECACD431B060W	268229	5
3	1	120	ECACA431B120	268159	72	ECACD431B072W	268230	5
3	1	208	ECACA431B208	268160	110	ECACD431B110W	268231	5
3	1	230	ECACA431B230	268161	125	ECACD431B125W	268232	5
3	1	240	ECACA431B240	268162	230	ECACD431B230W	268233	5
3	1	400	ECACA431B400	268163	250	ECACD431B250W	268234	5
3	1	440	ECACA431B440	268164	400	ECACD431B440W	268235	5
3	1	480	ECACA431B480	268165				
3	1	500	ECACA431B500	268166	24	ECACD431B024L	268236	5
3	1	575	ECACA431B575	268674	48	ECACD431B048L	268237	5
3	1	600	ECACA431B600	268167	110	ECACD431B110L	268238	5
3	1				230	ECACD431B230L	268239	5
2	2	12	ECACA422B012	268168	12	ECACD422B012W	268240	5
2	2	24	ECACA422B024	268169	24	ECACD422B024W	268241	5
2	2	42	ECACA422B042	268170	36	ECACD422B036W	268242	5
2	2	48	ECACA422B048	268171	48	ECACD422B048W	268243	5
2	2	110	ECACA422B110	268172	60	ECACD422B060W	268244	5
2	2	120	ECACA422B120	268173	72	ECACD422B072W	268245	5
2	2	208	ECACA422B208	268174	110	ECACD422B110W	268246	5
2	2	230	ECACA422B230	268175	125	ECACD422B125W	268247	5
2	2	240	ECACA422B240	268176	230	ECACD422B230W	268248	5
2	2	400	ECACA422B400	268177	250	ECACD422B250W	268249	5
2	2	440	ECACA422B440	268178	400	ECACD422B440W	268250	5
2	2	480	ECACA422B480	268179				
2	2	500	ECACA422B500	268180	24	ECACD422B024L	268251	5
2	2	575	ECACA422B575	268675	48	ECACD422B048L	268252	5
2	2	600	ECACA422B600	268181	110	ECACD422B110L	268253	5
2	2				230	ECACD422B230L	268254	5
1	3	12	ECACA413B012	268182	12	ECACD413B012W	268400	5
1	3	24	ECACA413B024	268183	24	ECACD413B024W	268401	5
1	3	42	ECACA413B042	268184	36	ECACD413B036W	268402	5
1	3	48	ECACA413B048	268185	48	ECACD413B048W	268403	5
1	3	110	ECACA413B110	268186	60	ECACD413B060W	268404	5
1	3	120	ECACA413B120	268187	72	ECACD413B072W	268405	5
1	3	208	ECACA413B208	268188	110	ECACD413B110W	268406	5
1	3	230	ECACA413B230	268189	125	ECACD413B125W	268407	5
1	3	240	ECACA413B240	268190	230	ECACD413B230W	268408	5
1	3	400	ECACA413B400	268191	250	ECACD413B250W	268409	5
1	3	440	ECACA413B440	268192	400	ECACD413B440W	268410	5
1	3	480	ECACA413B480	268193				
1	3	500	ECACA413B500	268194	24	ECACD413B024L	268411	5
1	3	575	ECACA413B575	268676	48	ECACD413B048L	268412	5
1	3	600	ECACA413B600	268195	110	ECACD413B110L	268413	5
1	3				230	ECACD413B230L	268414	5
0	4	12	ECACA404B012	268196	12	ECACD404B012W	268270	5
0	4	24	ECACA404B024	268197	24	ECACD404B024W	268271	5
0	4	42	ECACA404B042	268198	36	ECACD404B036W	268272	5
0	4	48	ECACA404B048	268199	48	ECACD404B048W	268273	5
0	4	110	ECACA404B110	268200	60	ECACD404B060W	268274	5
0	4	120	ECACA404B120	268201	72	ECACD404B072W	268275	5
0	4	208	ECACA404B208	268202	110	ECACD404B110W	268276	5
0	4	230	ECACA404B230	268203	125	ECACD404B125W	268277	5
0	4	240	ECACA404B240	268204	230	ECACD404B230W	268278	5
0	4	400	ECACA404B400	268205	250	ECACD404B250W	268279	5
0	4	440	ECACA404B440	268206	400	ECACD404B440W	268280	5
0	4	480	ECACA404B480	268207				
0	4	500	ECACA404B500	268208	24	ECACD404B024L	268281	5
0	4	575	ECACA404B575	268677	48	ECACD404B048L	268282	5
0	4	600	ECACA404B600	268209	110	ECACD404B110L	268283	5
0	4				230	ECACD404B230L	268284	5

Catalogue number structure

Example: ECACA440B012

EC: Means Efficor Contactor range

AC: Auxiliary Contact

A: A stands for AC

D stands for DC

4: Available contacts

40 4NO/0NC

31 3NO/1NC

22 2NO/2NC

13 1NO/3NC

04 0NO/4NC

B: Type of terminal

B stands for Box terminal

R stands for Ring terminal

012: Coil voltage (012 up to 600V)

(1) End character: W = Wide voltage and built-in diode
L = Low consumption

Order codes

Intro

A

B

C

D

E

F

G

H

I

J/X

New



Spare coils for contactors and auxiliary contactors - Box clamp terminals

	Voltage	Use for	Cat. no.	Ref. no.	Pack
AC coil Voltage in AC 50/60Hz 	12Vac	EC09A..EC18A, ECACA..B	ECCS1A012S	268687	5
	24Vac	EC09A..EC18A, ECACA..B	ECCS1A024S	268688	5
	42Vac	EC09A..EC18A, ECACA..B	ECCS1A042S	268689	5
	48Vac	EC09A..EC18A, ECACA..B	ECCS1A048S	268690	5
	110Vac	EC09A..EC18A, ECACA..B	ECCS1A110S	268691	5
	120Vac	EC09A..EC18A, ECACA..B	ECCS1A120S	268692	5
	208Vac	EC09A..EC18A, ECACA..B	ECCS1A208S	268693	5
	230Vac	EC09A..EC18A, ECACA..B	ECCS1A230S	268694	5
	240Vac	EC09A..EC18A, ECACA..B	ECCS1A240S	268695	5
	400Vac	EC09A..EC18A, ECACA..B	ECCS1A400S	268696	5
	440Vac	EC09A..EC18A, ECACA..B	ECCS1A440S	268697	5
	480Vac	EC09A..EC18A, ECACA..B	ECCS1A480S	268698	5
	500Vac	EC09A..EC18A, ECACA..B	ECCS1A500S	268699	5
	575Vac	EC09A..EC18A, ECACA..B	ECCS1A575S	268984	5
	600Vac	EC09A..EC18A, ECACA..B	ECCS1A600S	268700	5
	DC Wide Voltage range (W) Operating range: +25% Un -30% Un	12Vdc	EC09D..EC18D, ECACD..B	ECCS1D012S	268701
24Vdc		EC09D..EC18D, ECACD..B	ECCS1D024S	268702	5
36Vdc		EC09D..EC18D, ECACD..B	ECCS1D036S	268703	5
48Vdc		EC09D..EC18D, ECACD..B	ECCS1D048S	268704	5
60Vdc		EC09D..EC18D, ECACD..B	ECCS1D060S	268705	5
72Vdc		EC09D..EC18D, ECACD..B	ECCS1D072S	268706	5
110Vdc		EC09D..EC18D, ECACD..B	ECCS1D110S	268707	5
125Vdc		EC09D..EC18D, ECACD..B	ECCS1D125S	268708	5
230Vdc		EC09D..EC18D, ECACD..B	ECCS1D230S	268709	5
250Vdc		EC09D..EC18D, ECACD..B	ECCS1D250S	268710	5
440Vdc		EC09D..EC18D, ECACD..B	ECCS1D440S	268711	5
DC Low Consumption (L) VDC < 3.3W for EC09 up to EC18		24Vdc	EC09D..EC18D, ECACD..B	ECCS1D024SL	268712
	48Vdc	EC09D..EC18D, ECACD..B	ECCS1D048SL	268713	5
	110Vdc	EC09D..EC18D, ECACD..B	ECCS1D110SL	268714	5
	230Vdc	EC09D..EC18D, ECACD..B	ECCS1D230SL	268715	5
AC coil Voltage in AC 50/60Hz 	12Vac	EC25A..EC40A..B	ECCS2A012S	268716	5
	24Vac	EC25A..EC40A..B	ECCS2A024S	268717	5
	42Vac	EC25A..EC40A..B	ECCS2A042S	268718	5
	48Vac	EC25A..EC40A..B	ECCS2A048S	268719	5
	110Vac	EC25A..EC40A..B	ECCS2A110S	268720	5
	120Vac	EC25A..EC40A..B	ECCS2A120S	268721	5
	208Vac	EC25A..EC40A..B	ECCS2A208S	268722	5
	230Vac	EC25A..EC40A..B	ECCS2A230S	268723	5
	240Vac	EC25A..EC40A..B	ECCS2A240S	268724	5
	400Vac	EC25A..EC40A..B	ECCS2A400S	268725	5
	440Vac	EC25A..EC40A..B	ECCS2A440S	268726	5
	480Vac	EC25A..EC40A..B	ECCS2A480S	268727	5
	500Vac	EC25A..EC40A..B	ECCS2A500S	268728	5
	575Vac	EC25A..EC40A..B	ECCS2A575S	268985	5
	600Vac	EC25A..EC40A..B	ECCS2A600S	268729	5
	DC Wide Voltage range (W) Operating range: +25% Un -30% Un	12Vdc	EC25AD..EC40D..B	ECCS2D012S	268730
24Vdc		EC25AD..EC40D..B	ECCS2D024S	268731	5
36Vdc		EC25AD..EC40D..B	ECCS2D036S	268732	5
48Vdc		EC25AD..EC40D..B	ECCS2D048S	268733	5
60Vdc		EC25AD..EC40D..B	ECCS2D060S	268734	5
72Vdc		EC25AD..EC40D..B	ECCS2D072S	268735	5
110Vdc		EC25AD..EC40D..B	ECCS2D110S	268736	5
125Vdc		EC25AD..EC40D..B	ECCS2D125S	268737	5
230Vdc		EC25AD..EC40D..B	ECCS2D230S	268738	5
250Vdc		EC25AD..EC40D..B	ECCS2D250S	268739	5
440Vdc		EC25AD..EC40D..B	ECCS2D440S	268740	5
DC Low Consumption (L) VDC < 5.5W for EC25 up to EC40		24Vdc	EC25AD..EC40D..B	ECCS2D024SL	268741
	48Vdc	EC25AD..EC40D..B	ECCS2D048SL	268742	5
	110Vdc	EC25AD..EC40D..B	ECCS2D110SL	268743	5
	230Vdc	EC25AD..EC40D..B	ECCS2D230SL	268744	5

Intro

A

B

C

D

E

F

G

H

I



J/X



New

Accessories for contactors

Auxiliary contact blocks

	Contacts				Box clamp terminals		Pack	
	NO	NC	NO EM	NC EM	Cat. no.	Ref. no.		
	•3 •4	•1 •2	•7 •8	•5 •6				
Frontal auxiliary blocks								
	2 contacts							
	1	1	-	-	ECFA211S	268872	5	
	2	0	-	-	ECFA220S	268873	5	
	0	2	-	-	ECFA202S	268874	5	
	4 contacts							
	4	0	-	-	ECFA440S	268881	5	
	3	1	-	-	ECFA431S	268882	5	
	2	2	-	-	ECFA422S	268883	5	
	1	3	-	-	ECFA413S	268884	5	
	0	4	-	-	ECFA404S	268885	5	
	1	1	1	1	ECFA422SE	268886	5	
	Lateral auxiliary blocks							
		Contact block						
		2	0	-	-	ECLA220S	268899	10
1		1	-	-	ECLA211S	268900	10	
0		2	-	-	ECLA202S	268901	10	
Mechanical interlock								
0		0	-	-	ECMI	268908	10	
0		2	-	-	ECMI02S	268910	10	

Pneumatic timer⁽¹⁾

	NO	NC	Time	Type	Box clamp terminals		Pack
					Cat. no.	Ref. no.	
	•7 •8	•5 •6					
	1	1	0.1-30 s	delay ON	ECPT30SC	268913	5
	1	1	1-60 s	delay ON	ECPT60SC	268914	5
	1	1	0.1-30 s	delay OFF	ECPT30SD	268916	5
	1	1	1-60 s	delay OFF	ECPT60SD	268917	5

All accessories can be used with all type of contactors.

(1) Use only with contactor coil in AC voltage.

Order codes

Intro

A

B

C

D

E

F

G

H

I

J/X



New

Accessories for contactors (continued)

Mechanical latch

NC	Use with	Coil voltage 50/60HZ	Coil voltage DC	Box clamp terminals		Pack
				Cat. no.	Ref. no.	
						
1	EC09A up to EC18A, ECACA	24-32V	-	ECML1AS032	268919	5
1	EC09A up to EC18A, ECACA	42-60V	-	ECML1AS060	268920	5
1	EC09A up to EC18A, ECACA	110-127V	-	ECML1AS127	268921	5
1	EC09A up to EC18A, ECACA	220-240V	-	ECML1AS277	268922	5
1	EC09A up to EC18A, ECACA	380-480V	-	ECML1AS480	268923	5
1	EC09A up to EC18A, ECACA	500-690V	-	ECML1AS660	268924	5
1	EC25A up to EC40A	24-32V	-	ECML2AS032	268925	5
1	EC25A up to EC40A	42-60V	-	ECML2AS060	268926	5
1	EC25A up to EC40A	110-127V	-	ECML2AS127	268927	5
1	EC25A up to EC40A	220-240V	-	ECML2AS277	268928	5
1	EC25A up to EC40A	380-480V	-	ECML2AS480	268929	5
1	EC25A up to EC40A	500-690V	-	ECML2AS660	268930	5
1	EC09D up to EC18D, ECACD	-	24-36V	ECML1DS036	269325 ⁽¹⁾	5
1	EC09D up to EC18D, ECACD	-	42-48V	ECML1DS048	269326 ⁽¹⁾	5
1	EC09D up to EC18D, ECACD	-	60-72V	ECML1DS072	269327 ⁽¹⁾	5
1	EC09D up to EC18D, ECACD	-	110-277V	ECML1DS177	269328 ⁽¹⁾	5
1	EC09D up to EC18D, ECACD	-	220-250V	ECML1DS250	269329 ⁽¹⁾	5
1	EC09D up to EC18D, ECACD	-	440V	ECML1DS440	269330 ⁽¹⁾	5
1	EC25D up to EC40D	-	24-36V	ECML2DS036	269331 ⁽¹⁾	5
1	EC25D up to EC40D	-	42-48V	ECML2DS048	269332 ⁽¹⁾	5
1	EC25D up to EC40D	-	60-72V	ECML2DS072	269333 ⁽¹⁾	5
1	EC25D up to EC40D	-	110-277V	ECML2DS277	269334 ⁽¹⁾	5
1	EC25D up to EC40D	-	220-250V	ECML2DS250	269335 ⁽¹⁾	5
1	EC25D up to EC40D	-	440V	ECML2DS440	269336 ⁽¹⁾	5



(1) No use with DC version low consumption



Surge suppressor (plug-in)

Description	Suppressor type	Voltage	Cat. no.	Ref. no.	Pack
Diode type, DC 12-440V	DI	DC	ECSUDI440	268931	10
RC type, AC 24-48V	RC	AC	ECSURC048	268932	10
RC type, AC 50-127V	RC	AC	ECSURC127	268933	10
RC type, AC 130-250V	RC	AC	ECSURC250	268934	10
RC type, AC 230-440V	RC	AC	ECSURC440	268935	10
RC type, AC 400-600V	RC	AC	ECSURC600	268936	10
Varistor type, AC/DC 24-48V	VA	AC/DC	ECSUVA048	268937	10
Varistor type, AC/DC 50-127V	VA	AC/DC	ECSUVA127	268938	10
Varistor type, AC/DC 130-250V	VA	AC/DC	ECSUVA250	268939	10
Varistor type, AC/DC 230-440V	VA	AC/DC	ECSUVA440	268940	10
Varistor type, AC/DC 400-600V	VA	AC/DC	ECSUVA600	268941	10

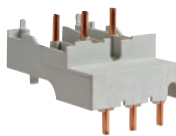
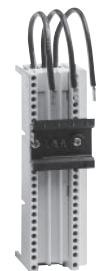

Accessories for starters

Fuseless starter kits

	Use with	Description	Cat. no.	Ref. no.	Pack
	GPS1 - EC09A up to EC25A	Link module	ECM1AL25	268954	5
	GPS1 - EC32A	Link module	ECM1AL32	268955	5
	GPS2 - EC32A and EC40A	Link module	ECM2AL40	268956	5
	GPS1 - EC09 up to EC25	25A - 60mm busbar adapter 45x200mm	PBF23EBDA	107152	4
	GPS2 - EC32 up to EC40	63A - 60mm busbar adapter 54x200	PBF23ECDA	107153	4
	EC09-EC40	45mm busbar adapter empty for reversing/star-delta application	ECBSRSD1	267403	4
	EC09-EC40	54mm busbar adapter empty for reversing/star-delta application	ECBSRSD2	267404	4
	EC09-EC40	9mm busbar adapter empty for contactor lateral blocks	ECBSLS	267405	10
		60mm universal busbar support	ECBS60S	267406	10
		Lateral protection for universal busbar support	ECBSLP	267407	10
	GPS1 - EC09 up to EC32	Base plate 45mm	ECBP45	268962	5
	GPS2 - EC32 and EC40	Base plate 55mm	ECBP55	268953	5

Wiring kits for reversing starters

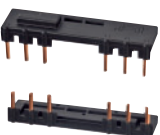
	Use with	Description	Cat. no.	Ref. no.	Pack
	EC09A up to EC25A	Suitable to be used for upper and lower connections with and without overload relay with mechanical interlock	ECKS1RV	268948	1
	EC32A and EC40A	Suitable to be used for upper and lower connections with and without overload relay with mechanical interlock	ECKS2RV	268950	1

Wiring kits for star delta starters

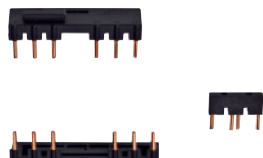
	Use with	Description	Cat. no.	Ref. no.	Pack
	EC09 up to EC25	Suitable to be used for upper and lower connections with and without overload relay	ECKS1YD	268951	1
	EC32 and EC40	Suitable to be used for upper and lower connections with and without overload relay	ECKS2YD	268952	1

Parallel busbar

	Use with	Description	Cat. no.	Ref. no.	Pack
	EC09 up to EC25	Parallel busbar for 2 contactors	ECBB1B2	268942	5
	EC32 and EC40	Parallel busbar for 2 contactors	ECBB2B2	268945	5

Parallel poles

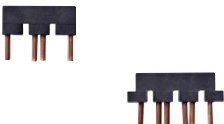
	Use with	Description	Cat. no.	Ref. no.	Pack
	EC09 up to EC25	3 poles in parallel	EC3PP1B	268943	6
	EC09 up to EC25	4 poles in parallel	EC4PP1B	268944	6
	EC32 and EC40	3 poles in parallel	EC3PP2B	268946	6
	EC32 and EC40	4 poles in parallel	EC4PP2B	268947	6

Order codes

Intro

A

B

C

D

E

F

G

H

I

J/X



New

Thermal overload relays

Thermal overload relays

Trip class 10	Setting range		Fuses		Use with	Box clamp terminals		
	Min. A	Max. A	AM A	gL-gG A		Cat. no.	Ref. no.	Pack
	0.16	0.26	2	2	EC09	ECRT1B10B	268996	5
	0.25	0.41	2	2		ECRT1B10C	268997	5
	0.40	0.65	2	2		ECRT1B10D	268998	5
	0.65	1.10	2	4		ECRT1B10F	268999	5
	1.00	1.50	4	6		ECRT1B10G	269000	5
	1.30	1.90	4	6		ECRT1B10H	269001	5
	1.80	2.70	6	10		ECRT1B10J	269002	5
	2.50	4.00	8	16		ECRT1B10K	269003	5
	4.00	6.30	12	20		ECRT1B10L	269004	5
	5.50	8.50	16	20		ECRT1B10M	269005	5
	8.00	12.00	20	25	ECRT1B10N	269006	5	
	10.00	16.00	25	35	ECRT1B10P	269007	5	
	14.50	18.00	32	50	ECRT1B10S	269008	5	
	17.50	22.00	40	63	ECRT1B10T	269009	5	
	8.00	12.00	20	25	EC25	ECRT2B10N	268103	5
	10.00	16.00	25	35		ECRT2B10P	268104	5
	14.50	18.00	32	50		ECRT2B10S	268105	5
	17.50	22.00	40	63		ECRT2B10T	268106	5
	21.00	26.00	40	63		ECRT2B10U	268107	5
	25.00	32.00	50	80		ECRT2B10V	268108	5
30.00	40.00	63	100	ECRT2B10W		268109	5	

Accessories

Use with	Description	Cat. no.	Ref. no.	Pack
Base for separate mounting				
ECRT1	DIN EN500022-35	ECRT1BS	268963	1
ECRT2	DIN EN500022-35	ECRT2BS	268964	1
Push-button with flexible cable				
ECRT1	0.5 m	RTXS	113855	1
	1 m	RTXSL	113856	1
	backside reset	RTXBS	108864	1
Remote electrical reset				
ECRT1 and ECRT2	12 VAC/DC	RTXRRB	113661	1
	24 VAC/DC	RTXRRD	113662	1
	48 VAC/DC	RTXRRG	113663	1
	110-240VAC/DC	RTXRRJ	113664	1
	220/415VAC/DC	RTXRRN	113665	1
	380/480VAC/DC	RTXRRU	113666	1

Conformity to standards

IEC/EN 60947-1	GB14048.4
IEC/EN 60947-4-1	UL508
IEC/EN 60947-5-1	UL486E
IEC/EN 60947-5-4	CSA2.22-14
EN50011	NF F16 101/102
EN50012	
EN50005	

Approvals/Marking

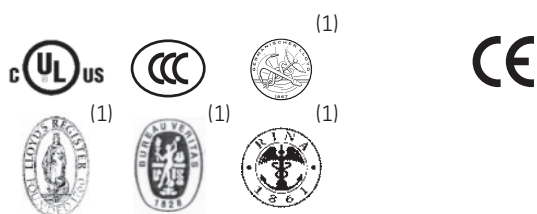

(1) In progress

Mounting positions

Installation capabilities

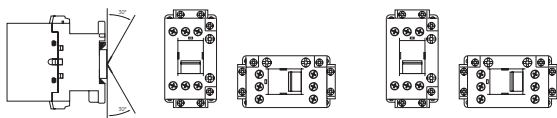

With de-rating values



-10% connection voltage -10% disconnection voltage with same rated power, data compared to vertical mounting



+10% disconnection voltage +10% connection voltage with same rated power, data compared to vertical mounting

Ambient conditions

Storage temperature	-55°C to +80°C
Operation temperature	-40°C to +55°C
	-40°C to +70°C ⁽¹⁾
Altitude	<2000m

(1) From 100% to 110% of rated control voltage, without additional auxiliary blocks

Climatic resistance (IEC 68-2)

Continuous tests 40 / 125 / 56	
Cold (72h)	Temperature -40°C
Dry heat (96h)	Temperature +125°C Relative humidity < 50%
Humid heat (56h)	Temperature +40°C Relative humidity 95%
Cyclic tests (6 cycles)	
First half-cycle	Humid heat Low temperature +25°C Relative humidity 93%
Second half-cycle	Low temperature +55°C Relative humidity 95%

Terminal capacity and tightening torque

	Conventional Thermal Current (Ith)		(A)	Head type	EC09 - EC18			EC25			EC32 - EC40		
	Box terminals				32			45			60		
	Solid, stranded and finely stranded w/o end sleeve	(mm ²)	Slot & PZ2	0.75..6	0.75...10	0.75..16							
	Finely stranded with end sleeve	(mm ²)	Slot & PZ2	0.75..6	0.75...10	0.75..16							
	Finely stranded w/o end sleeve	(mm ²)	Slot & PZ2	0.75..6	0.75...10	0.75..16							
	AWG wires			18..10	18..8	18..6							
	Tightening torque	(Nm) (Lb x in.)		2.2 / 20	2.2 / 20	2.2 / 20							
	Finely stranded w/o end sleeve	(mm ²)	Slot & PZ2	0.75..6	0.75...10	0.75..16							
	AWG wires			18..10	18..8	18..6							
	Tightening torque	(Nm) (Lb x in.)		2.2 / 20	2.2 / 20	2.2 / 20							
	Finely stranded with end sleeve	(mm ²)	Slot & PZ2	0.75..6	0.75...10	0.75..16							
	AWG wires			18..10	18..8	18..6							
	Tightening torque	(Nm) (Lb x in.)		2.2 / 20	2.2 / 20	2.2 / 20							

Electrical endurance

Category AC1 (3P & 4P contactors)

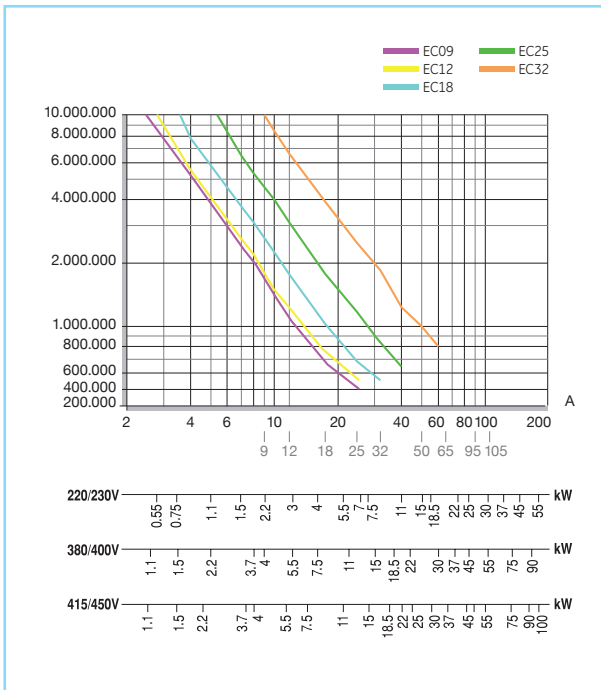

Category AC3 (3P contactors)

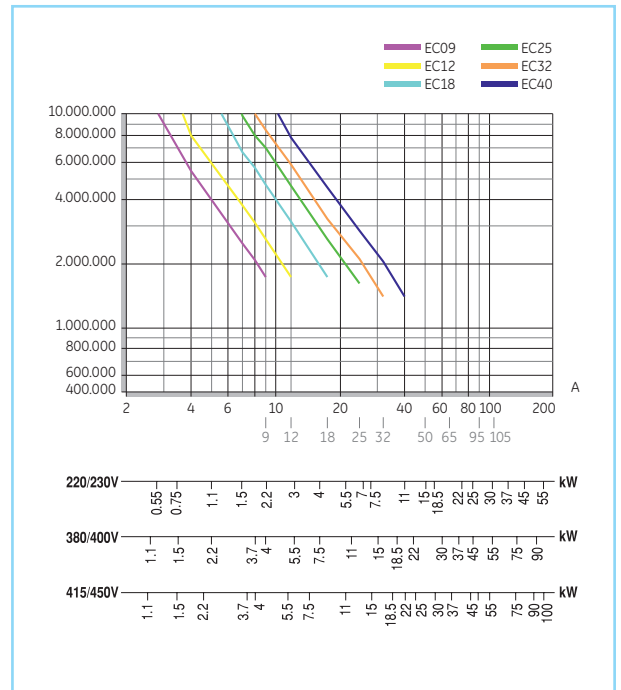

Category AC4 (3P contactors)

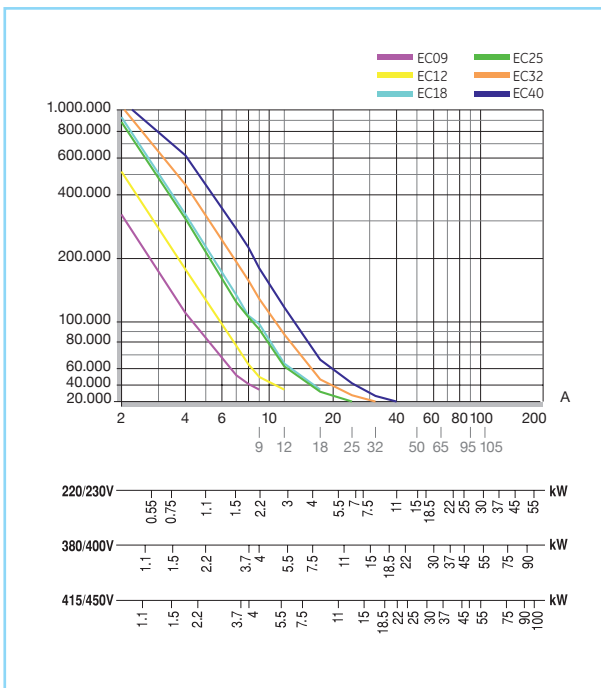

Power circuit

		EC 09	EC 12	EC18	EC 25	EC 32	EC 40
Three pole version							
Rated thermal current I _{th} at θ ≤ 55°C	(A)	25	25	32	45	60	60
Rated operational current I _e AC-3	(A)	9	12	18	25	32	40
Rated operational voltage U _e	(V)	690V acc. IEC 60947-4-1 / 600V acc. UL-CSA					
Four pole version							
Rated thermal current I _{th} at θ ≤ 55°C	(A)	-	25	32	45	60	-
Rated operational voltage U _e	(V)	690V acc. IEC 60947-4-1 / 600V acc. UL-CSA					
Three and four pole version							
Rated insulation voltage U _i	(V)	1000V acc. IEC 60947-4-1 / 600V acc. UL-CSA					
Maximum continuous current AC-1	(A)	25	25	32	45	60	60
Frequency limits	(Hz)	25..400	25..400	25..400	25..400	25..400	25..400
Making capacity (RMS) (IEC- 60947) U = 500V	(A)	220	220	220	315	520	520
Breaking capacity (RMS) (acc. IEC-60947)							
U _e = 500V	(A)	220	220	220	315	520	520
U _e = 690V	(A)	120	120	120	144	232	232
Short-time current from cold state							
1s	(A)	570	570	570	790	1265	1265
5s	(A)	254	254	254	355	565	565
10s	(A)	180	180	180	250	400	400
30s	(A)	104	104	104	145	231	231
1min	(A)	74	74	74	102	164	164
3min	(A)	42	42	42	60	95	95
Recovery time	(min)	10	10	10	10	10	10
Protection against short-circuit with fuses without thermal overload relay							
Coordination type 1							
gL-gG (U = 500V, 50kA or U = 415V, 80kA)	(A)	40	40	50	63	80	80
Coordination type 2							
gL-gG (U = 500V, 50kA or U = 415V, 80kA)	(A)	25	35	40	50	63	80
Average Impedance per pole	(mΩ)	2.25	2.25	2.25	1.6	1.2	1.2
Power dissipation per pole							
AC-1	(W)	1.41	1.41	2.30	3.24	4.32	4.32
AC-3	(W)	0.18	0.32	0.73	1.00	1.23	1.92
Insulation resistance							
Between adjacent poles	(MΩ)	>10	>10	>10	>10	>10	>10
Between poles and earth	(MΩ)	>10	>10	>10	>10	>10	>10
Between input and output	(MΩ)	>10	>10	>10	>10	>10	>10



Control circuit - Alternating current

		EC09 up to EC18	EC25 up to EC40
Rated insulation voltage Ui	(V)	1000	1000
Standard voltages Us 50Hz	(V)	12-600	12-600
Standard voltages Us 60Hz	(V)	12-600	12-600
Voltage operating limits 50/60Hz coils			
Operating 50Hz xUs		0.8 -1.1	0.8 -1.1
Operating 60Hz xUs		0.85-1.1	0.85-1.1
Pick-up 50Hz xUs		0.5..0.8	0.6..0.8
Pick-up 60Hz xUs		0.85-1.1	0.85-1.1
Drop out 50Hz xUs		0.35...0.55	0.30...0.55
Drop out 60Hz xUs		0.35...0.55	0.30...0.55
Maximum consumption bifrequency coils (cold state)			
Magnetic circuit closed (50Hz/60Hz)	(VA)	9.8 / 6.8	11.4 / 7.6
Magnetic circuit opened (50Hz/60Hz)	(VA)	70.1 / 68.2	144 / 138
Power factor			
Magnetic circuit closed cos φ		0.24	0.20
Magnetic circuit opened cos φ		0.85	0.70
Opening and closing times			
Values between +10% Us and -20% Us			
Making time on energisation (NO)	(ms)	10 - 25	10 - 25
Breaking time on de-energisation (NO)	(ms)	5 - 15	5 - 15
Values at Us			
Making time on energisation (NO)	(ms)	10 - 25	10 - 25
Making time on de-energisation (NO)	(ms)	5 - 15	5 - 15
Mechanical endurance			
Bifrequency coils (at 50Hz)	10 ⁶ ops.	10	10
Maximum rate			
AC-1 at rated power	ops./h	1200	1200
AC-2 at rated power	ops./h	1200	1000
AC-3 at rated power	ops./h	1200	1000
AC-4 at rated power	ops./h	360	240
No load	ops./h	7200	7200

Control circuit - Direct current

		Coils with Wide voltage range		Coils with Low consumption	
		EC09 up to EC18	EC25 up to EC40	EC09 up to EC18	EC25 up to EC40
Rated insulation voltage Ui	(V)	1000	1000	1000	1000
Standard voltages Us DC	(V)	12 - 400	12 - 400	12 - 400	12 - 400
Operating Limits					
Operating xUs	(VDC)	0.70 - 1.25	0.70 - 1.25	0.80 - 1.1	0.80 - 1.1
Pick Up xUs	(VDC)	0.45 - 0.65	0.45 - 0.65	0.48 - 0.68	0.48 - 0.68
Drop Out xUs	(VDC)	0.12 - 0.30	0.12 - 0.30	0.12 - 0.30	0.12 - 0.30
Maximum consumption at Us					
Magnet circuit open and closed (cold state)	(W)	7.5	9.5	3.6	5.5
Opening and closing times					
Values between +10% Us and -20% Us					
Making time on energisation (NO)	(ms)	33 - 78	35 - 154	47 - 173	48 - 96
Breaking time on de-energisation (NO)	(ms)	14 - 18	15 - 26	12 - 15	8 - 26
Values at Us					
Making time on energisation (NO)	(ms)	33 - 78	35 - 66	44 - 83	33 - 75
Breaking time on de-energisation (NO)	(ms)	14 - 18	15 - 24	13 - 20	12 - 24
Mechanical endurance					
	10 ⁶ ops.	10	10	10	10
Maximum rate					
AC-1 at rated power	ops./h	1200	1200	1200	1200
AC-2 at rated power	ops./h	1200	1000	1200	1000
AC-3 at rated power	ops./h	1200	1000	1200	1000
AC-4 at rated power	ops./h	360	240	360	240
No load	ops./h	7200	7200	7200	7200

(1) 4.4 for 230 Vdc version

A

B

C

D

E

F

G

H

I

J/X

New



Built-in auxiliary contacts

		EC09 up to EC25
Rated insulation voltage U_i according to IEC 60947	(V)	1000
Rated thermal current I_{th} at $\theta \leq 55^\circ\text{C}$	(A)	10
Making capacity (r.m.s.) acc. to IEC 60947		
AC-15 $U_e \leq 400\text{V}$, 50/60Hz	(A)	105
DC-13 $U_e \leq 220\text{Vdc}$	(A)	105
Breaking capacity (r.m.s.) acc. to IEC 60947		
AC-15 $U_e \leq 400\text{V}$, 50/60Hz	(A)	105
DC-13 $U_e \leq 220\text{Vdc}$	(A)	2
AC-15 rated voltage and current U_e - I_e according to IEC	(V-A)	110/120-10
		220/230-10 380/400-6 415/450-5 500-4 690/660-2
according to UL, CSA		A600
DC-13 rated voltage and current U_e - I_e according to IEC	(V-A)	24-6
		48-4 110-2 220-0.7 440-0.35
according to UL, CSA		Q600
Electrical endurance	10^6 ops.	0.2
Minimum operational power (operational safety)		17 V - 5mA
Short-circuit protection Max. fuse class gl-gG without welding	(A)	10
Insulation resistance	Between contacts	(M Ω)
	Between contacts and earth	(M Ω)
		>10
Guaranteed no overlap between NO and NC contacts		
Space		1.3mm
Impedance of the contacts	(M Ω)	2.7

Auxiliary contact blocks

		ECFA/ECLA
Rated insulation voltage U_i according to IEC 60947	(V)	1000
Rated thermal current I_{th} at $\theta \leq 55^\circ\text{C}$	(A)	10
Making capacity (I_{eff}) according to IEC 60947		
AC-15 $U_e \leq 400\text{V}$, 50/60Hz	(A)	60
DC-13 $U_e \leq 220\text{Vdc}$	(A)	60
Breaking capacity (I_{eff}) according to IEC 60947		
AC-15 $U_e \leq 400\text{V}$, 50/60Hz	(A)	60
DC-13 $U_e \leq 220\text{V}$, DC	(A)	0.95
AC-15 rated voltage and current U_e - I_e according to IEC	(V-A)	110/120-6
		220/230- 6 380/400-4 415/450-3.5 500-2.5 690/660-1.5
according to UL, CSA		A600
DC-13 rated voltage and current U_e - I_e according to IEC	(V-A)	24-4
		48-2 110-0.7 220-0.3 440-0.15
according to UL, CSA		Q600
Electrical endurance	10^6 ops.	0.2
Mechanical endurance	10^6 ops.	10
Minimum operational current (operational safety)		17-5 V-mA
Short-circuit protection Max. fuse class gl-gG without welding	(A)	10
Insulation resistance	Between contacts	(M Ω)
	Between contacts and earth	(M Ω)
		>10
Guaranteed no overlap between NO and NC contacts		
Space		1.6mm for ECFA / 2.2mm for ECLA
Impedance of the contacts	(M Ω)	2.7

Mechanical latch blocks

Rated insulation voltage U_i	(V)	1000
Standard voltages U_s : 50 to 60Hz and DC	(V)	24-660 & 24-440
Operating limits		85% to 110%
Consumption for unlatching (auto cut-out)		
24 to 72V		30W / 25VA
110 to 440V		15W / 12VA
Electrical unlatching control		18
Minimum impulse	(ms)	15 - 25
Maintained		Auto cut by internal contact
Manual unlatching control		By manual push-button
Electrical making control		
Minimum pulse	(ms)	40 (auto cut)
Manual making control		By manual push-button
Auxiliary contact NC		
AC-15 utilisation according to IEC	(V-A)	110/120-6 220/230-6 380/400-4 415/450-3.5 500-2.5 690/660-1.5
according to UL/CSA		A600
DC-13 utilisation according to IEC	(V-A)	24-4 48-2 110-0.7 220-0.3 440-0.15
according to UL/CSA		Q600
Mechanical endurance	10^6 ops.	0.2

Wiring diagrams

Alternating current

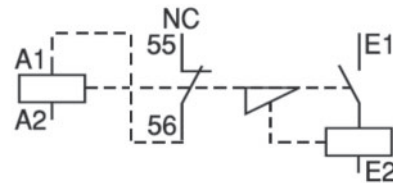

Alternating current / Direct current

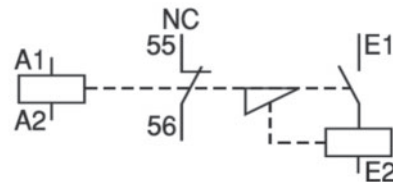

Terminal capacity

Terminal capacity		Screw plate ECMLSA, ECMLSD
Flexible wire	(mm ²)	2x0.5...2.5
AWG wire	(mm ²)	2x20...14
Standard gauge		A3
Tightening torque	(Nm/Lb-in)	1.1 / 10

Thermal mechanical overload relays for contactors from 0.16 to 40A

- Control circuit up to 690VAC
- Power circuit ECRT1, ECRT2: up to 690V
- Thermal protection against balanced overload.
- Three-pole differential (phase unbalance protection).
- Automatic ambient temperature compensation.
- Front mounted selector for choosing utilization current.
- Manual trip lever (tripping test).
- Tripping indicator (0-1).
- IP20 protection
- Reset button, 4 positions:
 - Manual RESET
 - Manual RESET and STOP
 - Automatic RESET with STOP
 - Automatic RESET without STOP

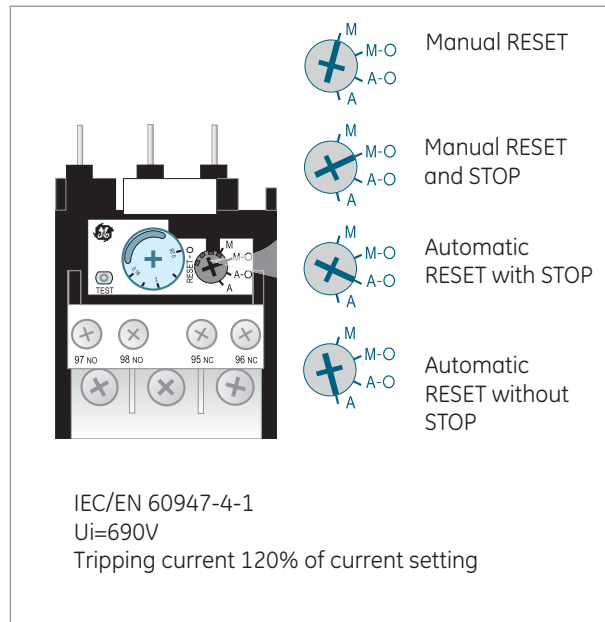

Standards

- IEC 7 EN 60947-4-1
- IEC EN 60947-5-1
- GB14048.4
- UL508
- CSA22.2/14
- VDE 0660

Approvals/Marking

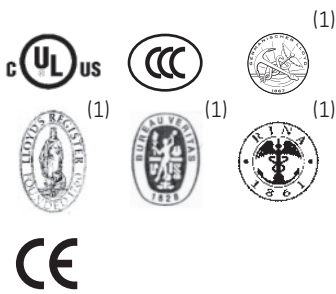

(1) In progress

Tripping curves

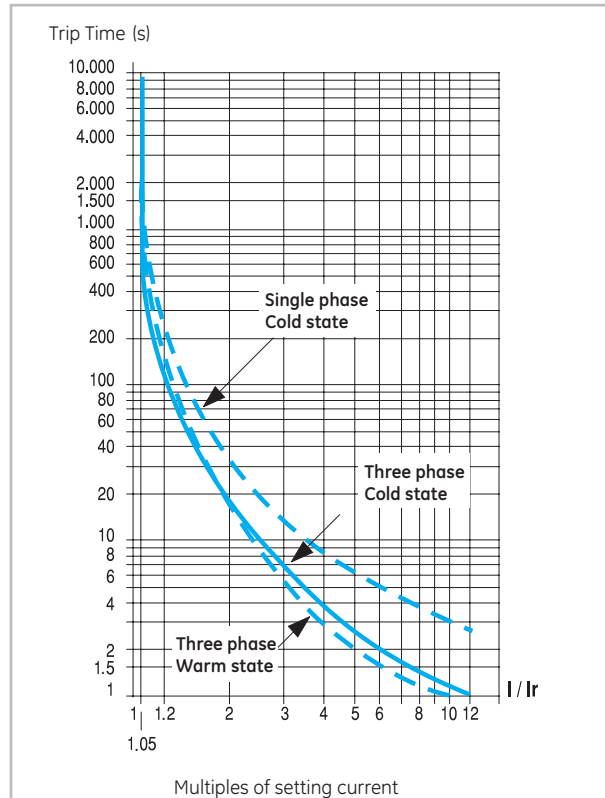

Thermal mechanical overload relays

Class	10A					
Setting range	(A)	0.16...40				
Suitable for	All Efficor contactors					
Main circuit						
Rated insulation voltage	(V)	690				
Frequency limits	(Hz)	0-400				
Control circuit						
Rated insulation voltage (IEC60947-4) Ui	(V)	690				
Rated thermal current Ith	(A)	10				
Operation current						
AC-15 - rated voltage and current Ue-le	(V-A)	110/120-3	220/230-2	380/400-1	480/500-0.8	690/660-0.3
DC-13 - rated voltage and current Ue-le	(V-A)	24-2	48-1.4	110-0.6	220-0.3	440-0.1
Utilisation according UL and CSA		B600-Q600				
Protective fuse type gL	(A)	10				
Terminal capacity	(mm ²)	0.75..10				
Tightening capacity	(Nm)	2.2 / 20				

Terminal capacity

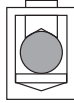
Clamp terminal - Flexible	(mm ²)		0.75..10
			18.8
Clamp terminal - Standard gauge			B6
			2.2 / 20

Ambient conditions

Storage temperature	-55°C to +80°C
Operation temperature (compensated)	-25°C to +60°C
Altitude <2000 m	without any changes in characteristics
Relative humidity	40°C, 95% no cond.
Protection treatment	Salt spary test

Remote electrical reset

Power consumption	
AC	100VA
DC	100W

Coils not suitable for continuous operating duty

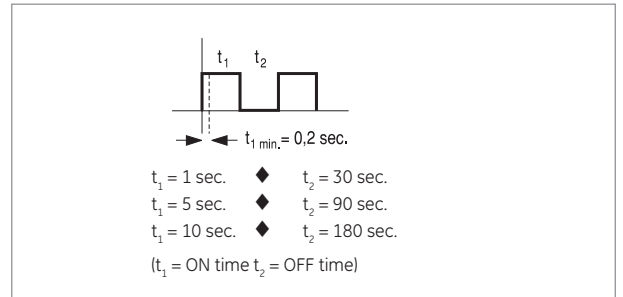

Mounting positions

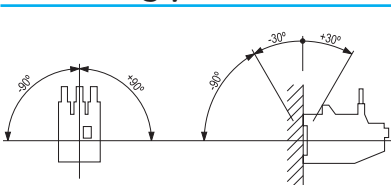

Inclination angle axis Y and Z: ±30°

Coordination table Type 2 with 50kA at 415V and 500V

Thermal Overload Relay	Current setting range (Aac)	415VAC												500VAC							
		Rated Power (kW)	Rated Current (A)	"I _n " Current (kA)	"I _q " Current (kA)	SCPD				With MCCB as SCPD				Rated Power (kW)	Rated Current (A)	"I _n " Current (kA)	"I _q " Current (kA)	With Fuse MMS as SCPD			
						SCPD		Contactor		SCPD (MCCB)		Contactor						SCPD		Contactor	
						Type	Rat. (Aac)	Type	Rat. (Aac)	Type	Rat. (Aac)	Type	Rat. (Aac)					Type	Rat. (Aac)	Type	Rat. (Aac)
ECRT1B10B	0.16 - 0.26	0.06	0.21	1	80	MMS	0.26	EC09A3	9	-	-	-	-	0.06	0.17	1	50	MMS	0.26	EC09A3	9
ECRT1B10C	0.25 - 0.41	0.09	0.31	1	80	Fuse	2	EC09A3	9	-	-	-	-	0.12	0.33	1	50	Fuse	2	EC09A3	9
ECRT1B10D	0.4 - 0.65	0.12	0.4	1	80	Fuse	4	EC09A3	9	-	-	-	-	0.18	0.48	1	50	Fuse	4	EC09A3	9
ECRT1B10F	0.65 - 1.1	0.25	0.8	1	80	Fuse	4	EC09A3	9	-	-	-	-	0.25	0.66	1	50	Fuse	4	EC09A3	9
ECRT1B10G	1.0 - 1.5	0.37	1.1	1	80	Fuse	6	EC09A3	9	-	-	-	-	0.55	1.2	1	50	Fuse	6	EC09A3	9
ECRT1B10H	1.3 - 1.9	0.55	1.5	1	80	Fuse	6	EC09A3	9	-	-	-	-	0.75	1.5	1	50	Fuse	6	EC09A3	9
ECRT1B10J	1.8 - 2.7	0.75	1.9	1	80	Fuse	6	EC09A3	9	-	-	-	-	1.1	2.1	1	50	Fuse	6	EC09A3	9
ECRT1B10K	2.5 - 4.0	1.5	3.4	1	80	Fuse	10	EC09A3	9	-	-	-	-	1.5	2.6	1	50	Fuse	10	EC09A3	9
ECRT1B10L	4.0 - 6.3	2.2	4.5	1	80	Fuse	16	EC09A3	9	-	-	-	-	3	5.3	1	50	Fuse	16	EC09A3	9
ECRT1B10M	5.5 - 8.5	3	6.5	1	80	Fuse	20	EC09A3	9	-	-	-	-	3.7	6	1	50	Fuse	20	EC09A3	9
ECRT1B10N/ ECRT2B10N	8.0 - 12	4	8	1	80	Fuse	25	EC09A3	9	MCCB	12.5	EC25A3	25	5.5	9	1	50	Fuse	25	EC09A3	9
ECRT1B10P/ ECRT2B10P	10.0 - 16.0	5.5	11	1	80	Fuse	35	EC012A3	12	MCCB	12.5	EC25A3	25	7.5	12	1	50	Fuse	35	EC12A3	12
ECRT1B10S/ ECRT2B10S	14.5 - 18.0	7.5	14.8	1	80	Fuse	40	EC018A3	18	MCCB	20	EC25A3	32	10	15.5	1	50	Fuse	40	EC18A3	18
ECRT1B10T/ ECRT2B10T	17.5 - 22	-	-	-	-	-	-	-	-	-	-	-	-	11	18.4	3	50	Fuse	40	EC18A3	18
ECRT2B10U	21.0 - 26	11	21	3	80	Fuse	50	EC025A3	25	MCCB	30	EC25A3	32	15	23	3	50	Fuse	50	EC25A3	25
ECRT2B10V	25.0 - 32.0	15	28	3	80	Fuse	63	EC032A3	32	MCCB	30	EC32A3	32	17.5	26.5	3	50	Fuse	63	EC32A3	32
ECRT2B10W	30.0 - 40	18.5	35	3	80	Fuse	80	EC040A3	40	MCCB	50	EC40A3	40	22	33	3	50	Fuse	80	EC40A3	40

Thermal overload relays, Trip Class: 10A
 Rated operational voltage: 415Vac, 500Vac
 Rated insulation voltage: 690Vac
 Rated frequency: 50Hz
 Rated duty: Eight hour duty
 Pollution degree: 3
 Rated conditional short-circuit protection device current: 80kA at 415Vac; 50kA at 500Vac



New

Surion GPS high breaking capacity (Thermal Magnetic). Coordination Type 2 - 65kA at 380/400 & 415V

Motor ⁽¹⁾			Manual Motor Starter				Contactor	Box clamp		Links
Rated Power	Rated current (A)		Cat.No.	Rated current (In)	Thermal current	Magnetic current	Series	Smallest wire Cu (pvc) ⁽²⁾	Minimum frontal electrical safety clearance	Cat.No.
	kW	380/400V								
0.06	0.23	0.21	GPS1BHAB	0.25	0.16-0.25	3.2	EC9A..	0.75	20	ECM1AL25
0.09	0.34	0.31	GPS1BHAC	0.4	0.25-0.4	5.2	EC9A..	0.75	20	ECM1AL25
0.12	0.44	0.4	GPS1BHAD	0.63	0.4-0.63	8.2	EC9A..	0.75	20	ECM1AL25
0.18	0.65	0.63	GPS1BHAE	1	0.63-1	13	EC9A..	0.75	20	ECM1AL25
0.25	0.9	0.8	GPS1BHAE	1	0.63-1	13	EC9A..	0.75	20	ECM1AL25
0.37	1.25	1.1	GPS1BHAF	1.6	1-1.6	20.5	EC9A..	0.75	20	ECM1AL25
0.55	1.6	1.5	GPS1BHAF	1.6	1-1.6	20.5	EC9A..	0.75	20	ECM1AL25
0.75	2	1.9	GPS1BHAG	2.5	1.6-2.5	32.5	EC9A..	0.75	20	ECM1AL25
1.1	2.6	2.5	GPS1BHAH	4	2.5-4	52	EC9A..	0.75	20	ECM1AL25
1.5	3.5	3.4	GPS1BHAH	4	2.5-4	52	EC9A..	0.75	20	ECM1AL25
2.2	5	4.5	GPS1BHAI	6.3	4-6.3	82	EC9A..	0.75	20	ECM1AL25
3	7	6.5	GPS1BHAK	10	6.3-10	130	EC9A..	1.5	20	ECM1AL25
4	9	8	GPS1BHAK	10	6.3-10	130	EC9A..	1.5	20	ECM1AL25
5.5	12	11	GPS1BHAL	13	9-13	169	EC12A..	2.3	20	ECM1AL25
7.5	16	14	GPS1BHAM	16	11-16	208	EC18A..	4	20	ECM1AL25
11	22.5	21	GPS1BHAP	25	19-25	325	EC25A..	6	20	ECM1AL25
15	30	28	GPS1BHAR	32	24-32	416	EC32A..	6	20	ECM1AL32
18.5	37	35	GPS2BHAS	40	28-40	520	EC40A..	10	20	ECM1AL32

(1) Current are relevant to four pole motors not having special characteristics of torque. Inrush currents: ≤ 8 time rated current for ≤ 1s.

(2) The minimum cycle cross-sections are referred to an ambient temperature of 30°C max. in free air and are selected to withstand the maximum let-through energy and the motor rated current. Besides the user has to consider the drop voltage, the type of laying and ambient temperature.

Global contactors

Intro

A

B

C

D

E

F

G

H

I

J/X

New



Record Plus Coordination Type 2 at 80kA at 380/400 & 415V

Motor ⁽¹⁾			MCCB				Contactor			Overload relay	Box clamp	Clearance	
Rated Power	Rated current (A)		Cat.No.	Rated current (In)	Thermal Current	Magnetic Current	Operating current	Admissible power	Setting Range	Smallest wire Cu (pvc) ⁽²⁾	Min. frontal electrical safety clearance		
	380/400V	415V										(A)	Setting range (A)
4	9	8	FD63	12.5	12.5	169	EC25A..	25	11	ECRT2	8-12	1.5	20
5.5	12	11	FD63	12.5	12.5	169	EC25A..	25	11	ECRT2	10-16	1.5	20
7.5	16	14.8	FD63	20	20	210	EC32A..	32	15	ECRT2	14.5-18	4	20
11	22.5	21	FD63	30	30	300	EC32A..	32	15	ECRT3	21-26	6	20
15	30	28	FD63	30	30	450	EC32A..	32	15	ECRT3	25-35	6	20
18.5	37	35	FD63	50	50	500	EC40A..	40	18.5	ECRT3	30-40	10	20

Record Plus Coordination Type 2 at 80kA at 500/525V

Motor ⁽¹⁾			MCCB				Contactor			Overload relay	Box clamp	Clearance	
Rated Power	Rated current (A)		Cat.No.	Rated current (In)	Thermal Current	Magnetic Current	Operating current	Admissible power	Setting Range	Smallest wire Cu (pvc) ⁽²⁾	Min. frontal electrical safety clearance		
	380/400V	415V										(A)	Setting range (A)
7.5	12		FD63	12.5	12.5	-	EC32A..	32	15	ECRT2	10-19	4	20
11	18.4		FD63	20	20	-	EC32A..	32	18.5	ECRT3	17.5-25	6	20
15	23		FD63	30	30	-	EC40A..	40	18.5	ECRT3	21-29	6	20
18.5	29		FD63	30	30	-	EC40A..	40	18.5	ECRT3	25-35	10	20

(1) Current are relevant to four pole motors not having special characteristics of torque. Inrush currents: ≤ 8 time rated current for ≤ 1s.

(2) The minimum cycle cross-sections are referred to an ambient temperature of 30°C max. in free air and are selected to withstand the maximum let-through energy and the motor rated current. Besides the user has to consider the drop voltage, the type of laying and ambient temperature.



New

Contact sequence

Device	Rating	Basic contactor	Built-in auxiliary		Auxiliary contact blocks - Front mounted-4P		
			NO	NC	40	.04	22
3P contactors 3NO	EC09	0 3.5 5	0 3.5 5	0 2 5			
	EC12						
	EC18				0 3 5	0 1.3 5	0 1.3 5
EC25	0 4 6	0 3.5 6	0 1.7 6				
				0 3 6	0 1.3 6	0 1.3 6	
EC32 EC40	0 4 6						
				0 3 6	0 1.2 6	0 1.2 6	
4P contactors 4NO	EC12						
	EC18						
4P contactors 2NO+2NC	EC09	0 3.3 5			0 3.3 5		
	EC12						
	EC18				0 1.7 5	0 1.7 5	0 1.7 5
EC25 EC32 EC40	0 4 6	0 2 6			0 4 6	0 2 6	0 2 6
				0 2 6	0 2 6	0 2 6	

Contact sequence (auxiliary contactors)

4P contactors 4NO	ECAC09	0 3.3 5			0 3.3 5		
	ECAC12						
	ECAC18						
	ECAC25	0 1.7 5			0 1.7 5	0 1.7 5	0 1.7 5
4P contactors 2NO+2NC	ECAC09	0 3.3 5			0 3.3 5		
	ECAC12						
	ECAC18						
	ECAC25	0 1.7 5			0 1.7 5	0 1.7 5	0 1.7 5



		Auxiliary contact blocks - Front mounted-2P				Auxiliary contact blocks - Front mounted-2P			
		31	13	11	02	20	02	20	11
0	3 5								
0	3 5	0 1.3 5	0 1.3 5	0 1.3 5	0 1.3 5		0 1.5 5		0 1.5 5
0	3 6								
0	3 6	0 1.3 6	0 1.3 6	0 1.1 6	0 1.1 6		0 1.3 6		0 1.3 6
0	3 6								
0	3 6	0 1.2 6	0 1.2 6	0 1.1 6	0 1.1 6		0 1.3 6		0 1.3 6
0	3.5 6	0 1.5 6	0 1.5 6	0 1.5 6	0 1.5 6		0 1.5 6		0 1.5 6
0	3.3 5								
0	3.3 5	0 1.7 5	0 1.7 5	0 1.7 5	0 1.7 5		1.7 5		0 1.7 5
0	4 6								
0	4 6	0 2 6	0 2 6	0 2 6	0 2 6		0 2 6		0 2 6
0	3.3 5								
0	3.3 5	0 1.7 5	0 1.7 5	0 1.7 5	0 1.7 5		0 1.7 5		0 1.7 5
0	3.3 5								
0	3.3 5	0 1.7 5	0 1.7 5	0 1.7 5	0 1.7 5		0 1.7 5		0 1.7 5

Technical data

Intro

A

B

C

D

E

F

G

H

I

J/X



New

Terminal numbering

3P and 4P contactors

EC09A311..EC25A311	EC32A300..EC40A300	EC12A400..EC32A400	EC12AB00.....EC25AB00	EC32AB00
EC09D311..EC25D311	EC32D300..EC40D300	EC12D400..EC32D400	EC12DB00.....EC25DB00	EC32DB00

Auxiliary contactors

ECACA440	ECACA431	ECACA422	ECACA413	ECACA404
ECACD440	ECACD431	ECACD422	ECACD413	ECACD404

Auxiliary contact blocks - Front mounting

ECFA440	ECFA404	ECFA422	ECFA431	ECFA413
ECFA211	ECFA220	ECFA202		

Auxiliary contact blocks - Lateral mounting

ECLA20	ECLA11	ECLA02
--------	--------	--------

Mechanical and mechanical/electrical interlock

ECMI	ECMI02
------	--------

A

B

C

D

E

F

G

H

I

J/X



Terminal numbering (continued)

Pneumatic timer blocks

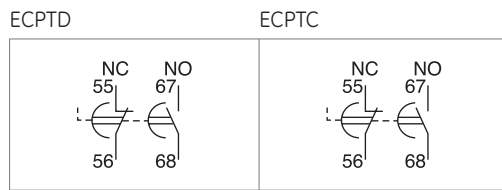

Voltage suppressor blocks

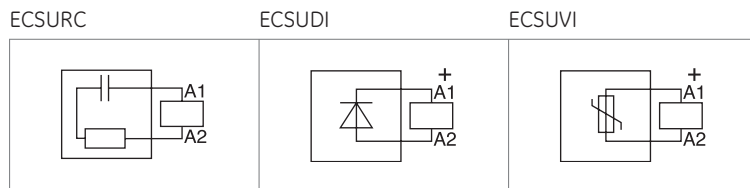

Mechanical latch block

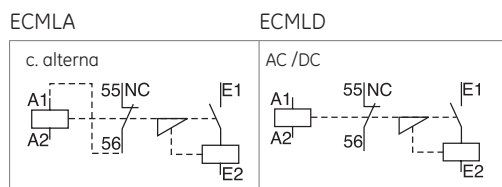

Terminal numbering according to EN 50011

Auxiliary contacts	Description	Symbol		Possible basic auxiliary contactors + Auxiliary contacts blocks to be added
		NO	NC	

4NO auxiliary contactor terminal combination with 2P FRONTAL block

	42E	4	2	ECACA440 ECACD440 +ECFA202	
	60E	6	0	ECACA440 ECACD440 +ECFA220	
	51E	5	1	ECACA440 ECACD440 +ECFA211	



4NO auxiliary contactor terminal combination with 4P FRONTAL block

	80E	8	0	ECACA440 ECACD440 +ECFA440	
	44E	4	4	ECACA440 ECACD440 +ECFA440	
	62E	6	2	ECACA440 ECACD440 +ECFA422	
	71E	7	1	ECACA440 ECACD440 +ECFA431	
	53E	5	3	ECACA440 ECACD440 +ECLFA413	







4NO auxiliary contactor terminal combination with LATERAL - block mounted on the RIGHT side of contactor

	42	4	2	ECACA440 ECACD440 +ECLA202	
	51	5	1	ECACA440 ECACD440 +ECLA211	
	60	6	0	ECACA440 ECACD440 +ECLA220	

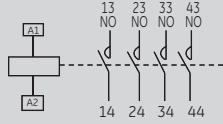

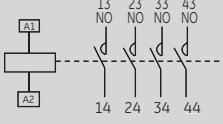

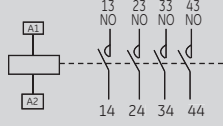

Terminal numbering according to EN 50011 (continued 1)

Auxiliary contacts	Description			Possible basic auxiliary contactors + Auxiliary contacts blocks to be added
--------------------	-------------	---	---	---

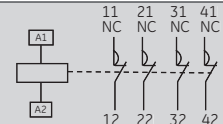

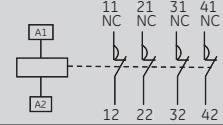

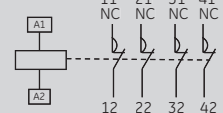



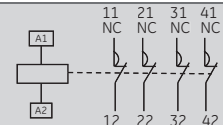

4NO auxiliary contactor terminal combination with LATERAL - block mounted on the LEFT side of contactor

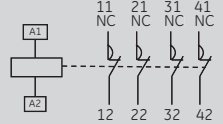
	42	4	2	ECACA440 ECACD440 +ECLA202	
	51	5	1	ECACA440 ECACD440 +ECLA211	
	6	6	0	ECACA440 ECACD440 +ECLA220	

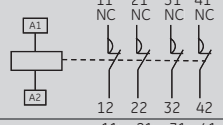

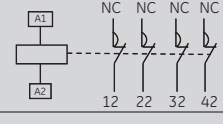
4NC auxiliary contactor terminal combination with 2P FRONTAL block

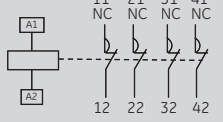
	06E	6	0	ECACA404 ECACD404 +ECFA202	
	24E	2	4	ECACA404 ECACD404 +ECFA220	
	15E	5	1	ECACD404 ECACA404 +ECFA211	



4NC auxiliary contactor terminal combination with 4P FRONTAL block

	44E	4	4	ECACA404 ECACD404 +ECFA440	
	08E	0	8	ECACA404 ECACD404 +ECFA404	
	26E	2	6	ECACA404 ECACD404 +ECFA422	
	35E	3	5	ECACA404 ECACD404 +ECFA431	
	17E	1	7	ECACA404 ECACD404 +ECLFA413	



Terminal numbering according to EN 50011 (continued 2)

Auxiliary contacts	Description			Possible basic auxiliary contactors + Auxiliary contacts blocks to be added
--------------------	-------------	---	---	---



4NC auxiliary contactor terminal combination with LATERAL - block mounted on the RIGHT side of contactor

	42	0	6	ECACA404 ECACD404 +ECLA202	
	15	1	5	ECACA404 ECACD404 +ECLA211	
	24	2	4	ECACA404 ECACD404 +ECLA220	

4NC auxiliary contactor terminal combination with LATERAL - block mounted on the LEFT side of contactor

	42	4	2	ECACA440 ECACD440 +ECLA202	
	51	5	1	ECACA440 ECACD440 +ECLA211	
	6	6	0	ECACA440 ECACD440 +ECLA220	







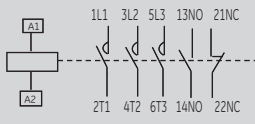
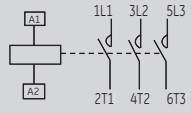



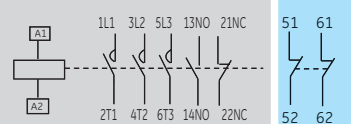

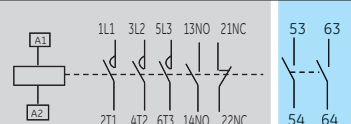
Terminal numbering according to EN 50012

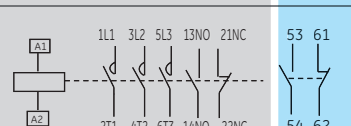
Auxiliary contacts	Description			Possible basic auxiliary contactors + Auxiliary contacts blocks to be added
--------------------	-------------	---	---	---

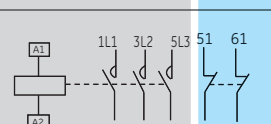
Terminal numbering according to EN 50012

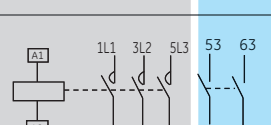
	11E	1	1	EC09A311..EC25A311 EC09D311..EC25D311
	-	0	0	EC32A300..EC40A300 EC32D300..EC40D300

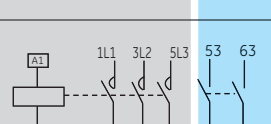
FRONT mounted auxiliary contact blocks with 2 contacts each

	13	1	3	EC09A311..EC25A311 EC09D311..EC25D311 +ECFA202	
	31	3	1	EC09A311..EC25A311 EC09D311..EC25D311 +ECFA220	
	22	2	2	EC09A311..EC25A311 EC09D311..EC25D311 +ECFA211	
	02	0	2	EC32A300..EC40A300 EC32D300..EC40D300 +ECFA202	
	20	2	0	EC32A300..EC40A300 EC32D300..EC40D300 +ECFA220	
	11	1	1	EC32A300..EC40A300 EC32D300..EC40D300 +ECFA211	

LATERAL mounted auxiliary contact blocks with 2 contacts each - RIGHT side mounted

	13	1	3	EC09A311..EC25A311 EC09D311..EC25D311 +ECLA220	
	22	2	2	EC09A311..EC25A311 EC09D311..EC25D311 +ECLA211	

Terminal numbering according to EN 50012 (continued 1)

Auxiliary contacts	Description	NO	NC	Possible basic auxiliary contactors + Auxiliary contacts blocks to be added
--------------------	-------------	----	----	---



LATERAL mounted auxiliary contact blocks with 2 contacts each - RIGHT side mounted (continued)

	31	3	1	EC09A311..EC25A311 EC09D311..EC25D311 +ECLA220	
	02	0	2	EC32A300..EC40A300 EC32D300..EC40D300 +ECLA202	
	11	1	1	EC32A300..EC40A300 EC32D300..EC40D300 +ECLA211	
	20	2	0	EC32A300..EC40A300 EC32D300..EC40D300 +ECLA220	

LATERAL mounted auxiliary contact blocks with 2 contacts each - LEFT side mounted

	13	1	3	EC09A311..EC25A311 EC09D311..EC25D311 +ECLA202	
	22	2	2	EC09D311..EC25D311 EC09A311..EC25A311 +ECLA211	
	31	3	1	EC09A311..EC25A311 EC09D311..EC25D311 +ECLA220	
	02	0	2	EC32A300..EC40A300 EC32D300..EC40D300 +ECLA202	
	11	1	1	EC32A300..EC40A300 EC32D300..EC40D300 +ECLA211	
	20	2	0	EC32A300..EC40A300 EC32D300..EC40D300 +ECLA220	

Terminal numbering according to EN 50012 (continued 2)

Auxiliary contacts	Description	 NO	 NC	Possible basic auxiliary contactors + Auxiliary contacts blocks to be added
--------------------	-------------	--	--	---

FRONT mounted auxiliary contact blocks with 4 contacts each

	51	5	1	EC09A311..EC25A311 EC09D311..EC25D311 +ECFA440	
	15	1	5	EC09A311..EC25A311 EC09D311..EC25D311 +ECFA404	
	33	3	3	EC09A311..EC25A311 EC09D311..EC25D311 +ECFA422	
	42	4	2	EC09A311..EC25A311 EC09D311..EC25D311 +ECFA431	
	24	2	4	EC09A311..EC25A311 EC09D311..EC25D311 +ECFA413	
	40	4	0	EC09A311..EC25A311 EC09D311..EC25D311 +ECFA440	
	04	0	4	EC09A311..EC25A311 EC09D311..EC25D311 +ECFA404	
	22	2	2	EC32A300..EC40A300 EC32D300..EC40D300 +ECFA422	
	31	3	1	EC32A300..EC40A300 EC32D300..EC40D300 +ECFA431	
	13	1	3	EC32A300..EC40A300 EC32D300..EC40D300 +ECFA413	

Dimensions and weights

Contactors

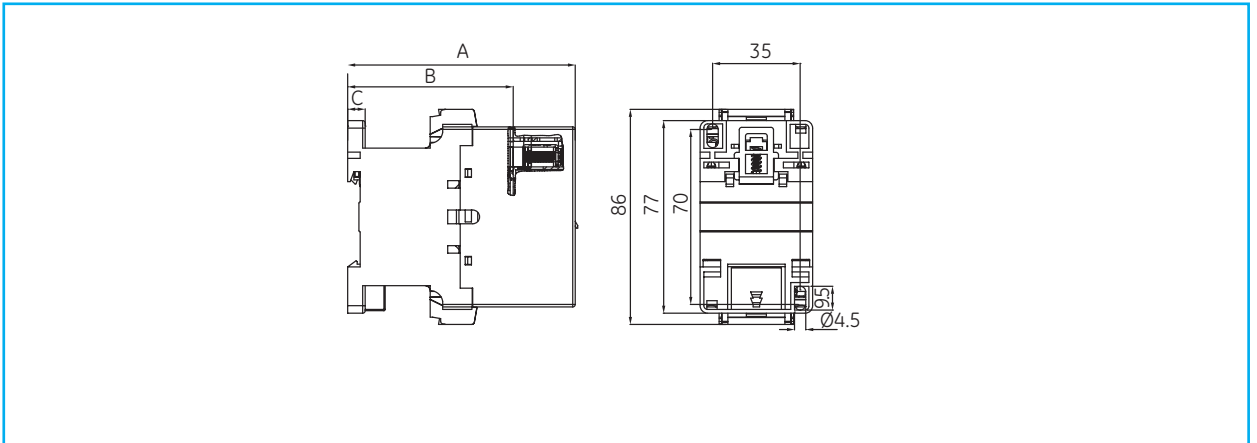

Dimensions in mm	EC09A3 - EC18A3	EC25A3	EC32A3 - EC40A3	EC09D3 - EC18D3	EC25D3	EC32D3 - EC40D3
A	92	97	102	102	110	115
B	66.2	66.2	67.2	76.2	80.2	81.2
C	7	7	7	7	7	7
Weight in g	350	490	530	620	700	740

Thermal overload relay ECRT1

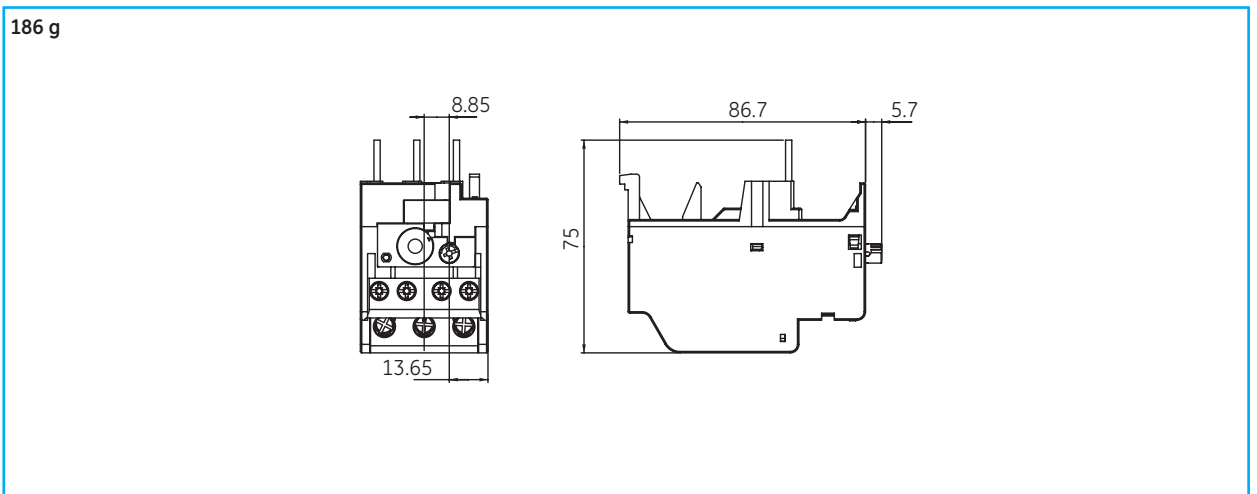

Thermal overload relay ECRT2

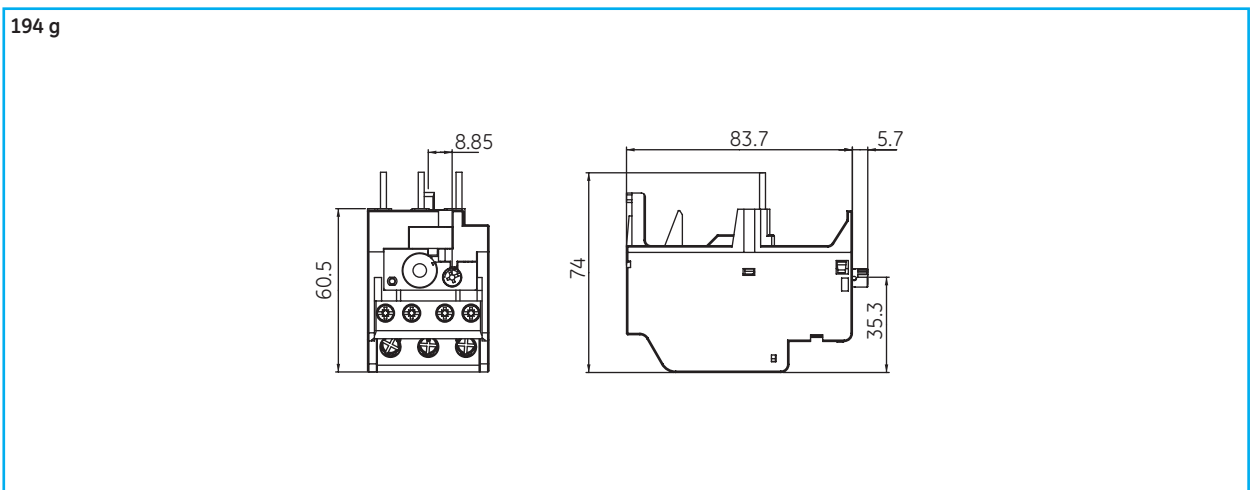

Combination of contactor EC09A-12A-18A and thermal overload relay ECRT1

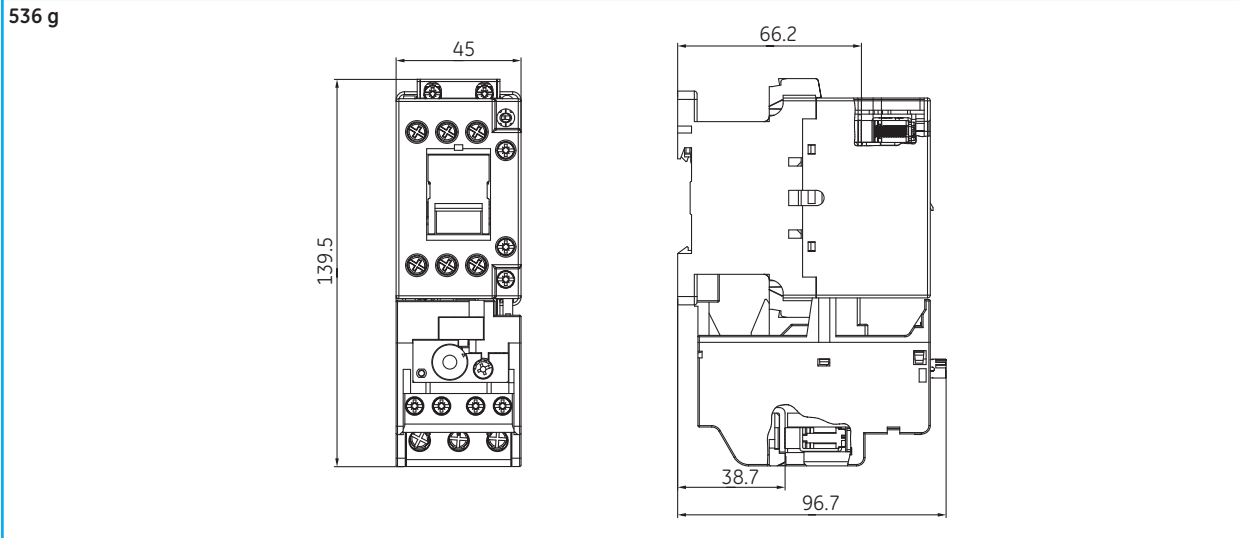

Combination of contactor EC25A and thermal overload relay ECRT2

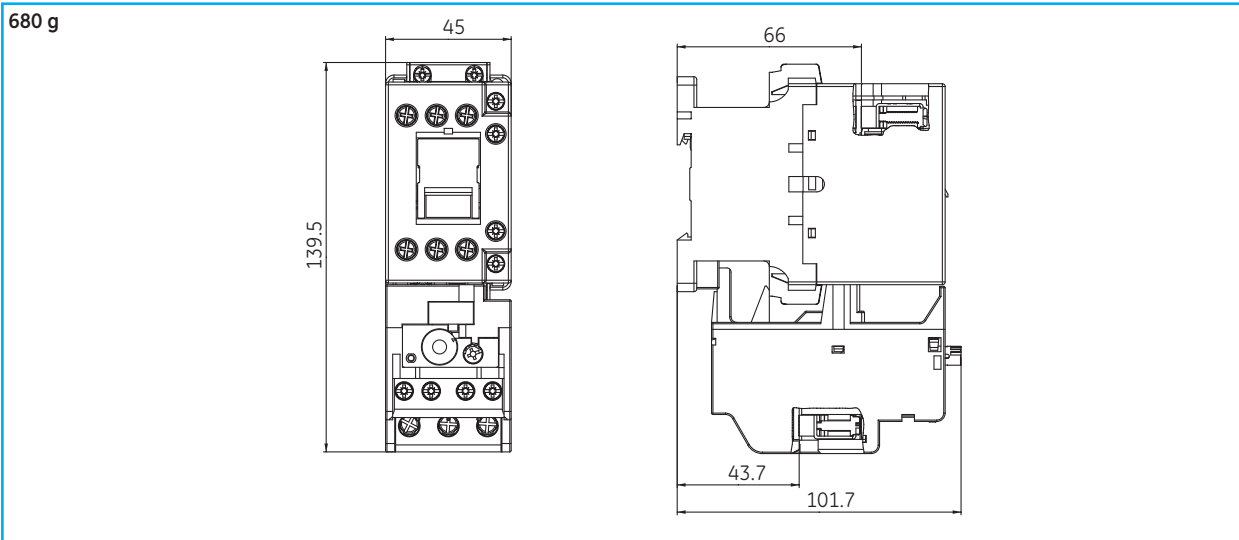

Combination of contactor EC32A-40A and thermal overload relay ECRT2

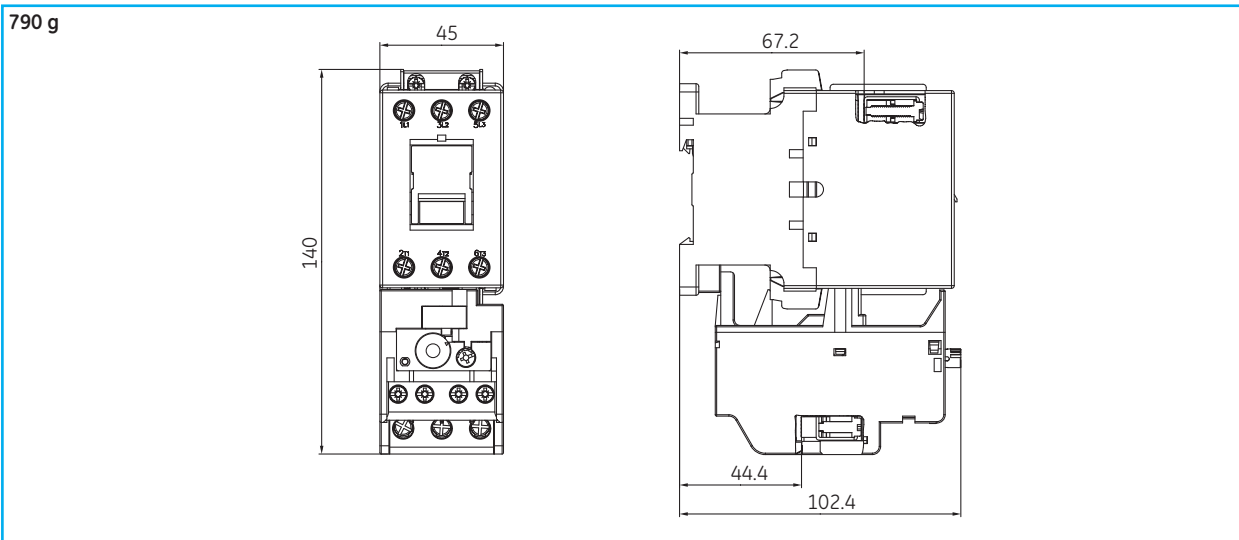

Technical data

Intro

A

B

C

D

E

F

G

H

I

J/X

New



Dimensions and weights

Auxiliary contactors ECACA

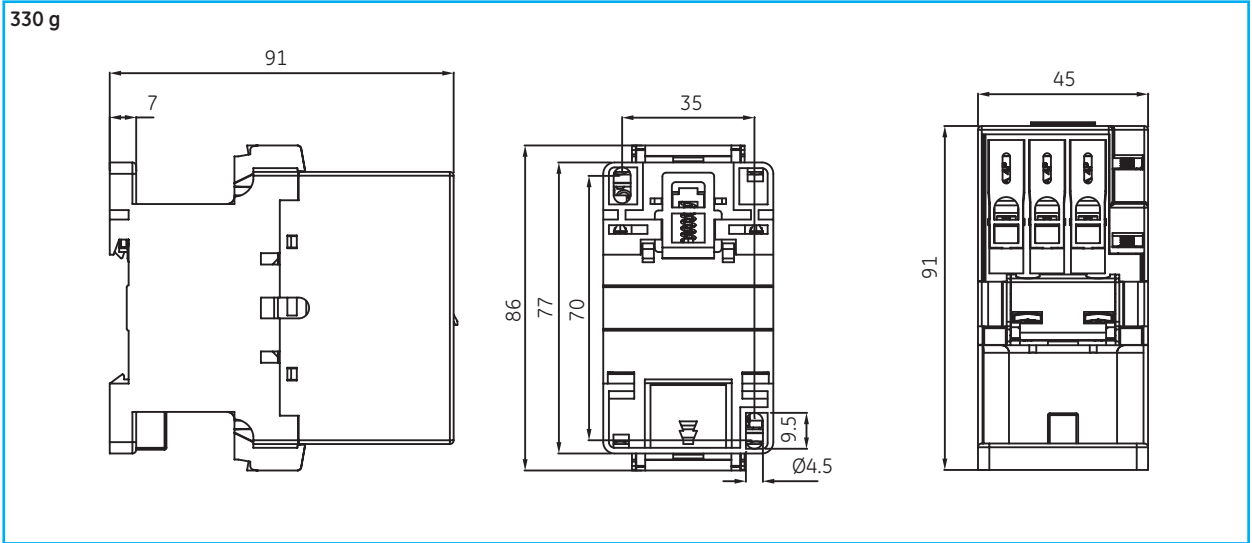

Frontal auxiliary contact block 2P ECFA2S

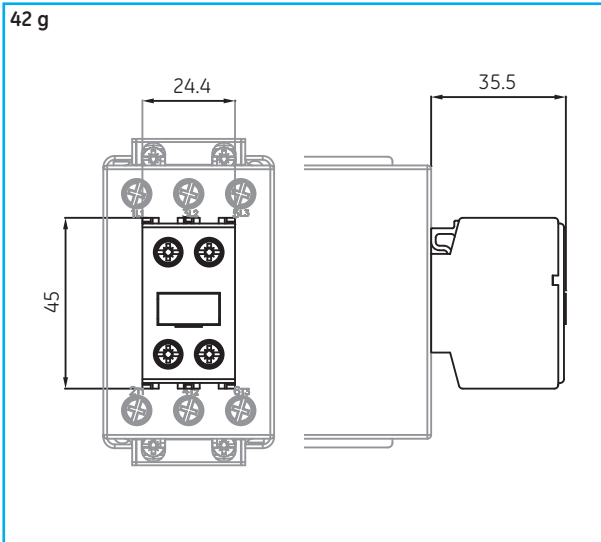

Frontal auxiliary contact block 4P ECFA4S

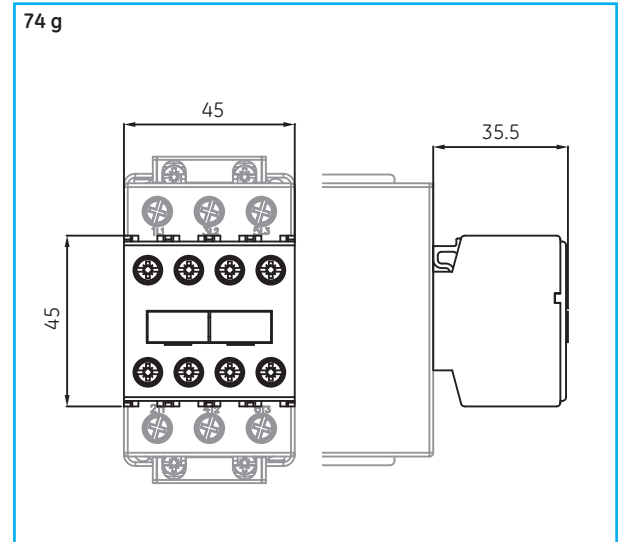

Lateral auxiliary contact block ECLA

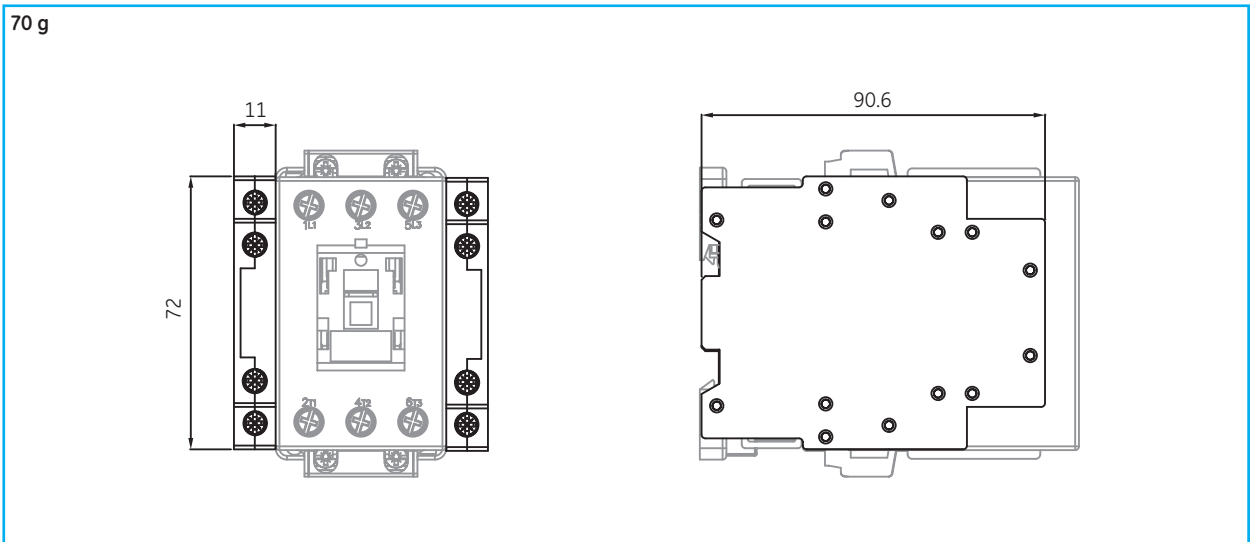

Lateral auxiliary mechanical interlock ECMI

52 g

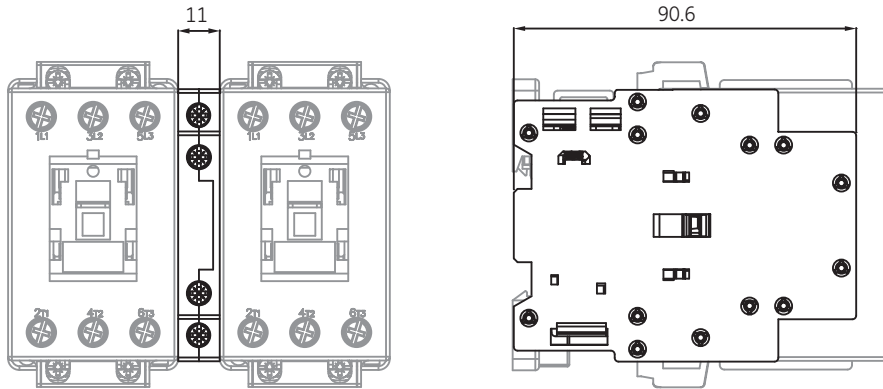

Pneumatic timer ECPT

78 g

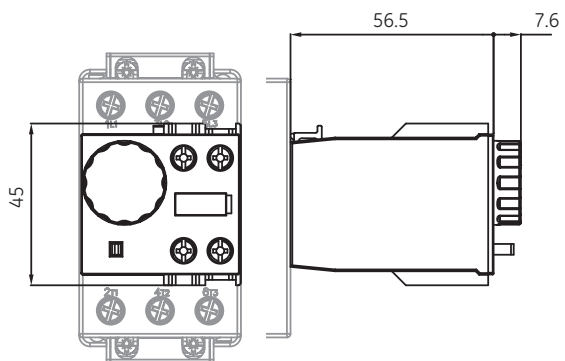

Mechanical latch ECML

113 g

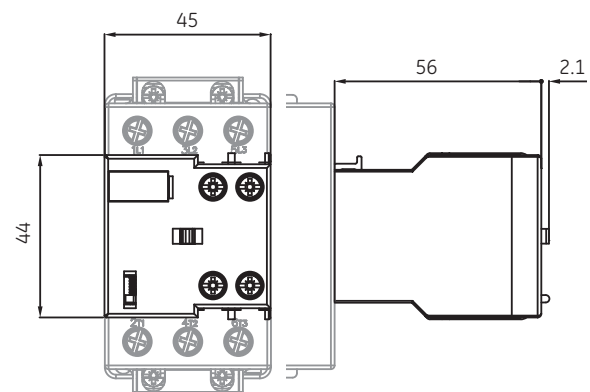

New

Dimensions and weights

Starter combination of manual motor starter Surion GPS1 and contactor EC09A-12A-18A

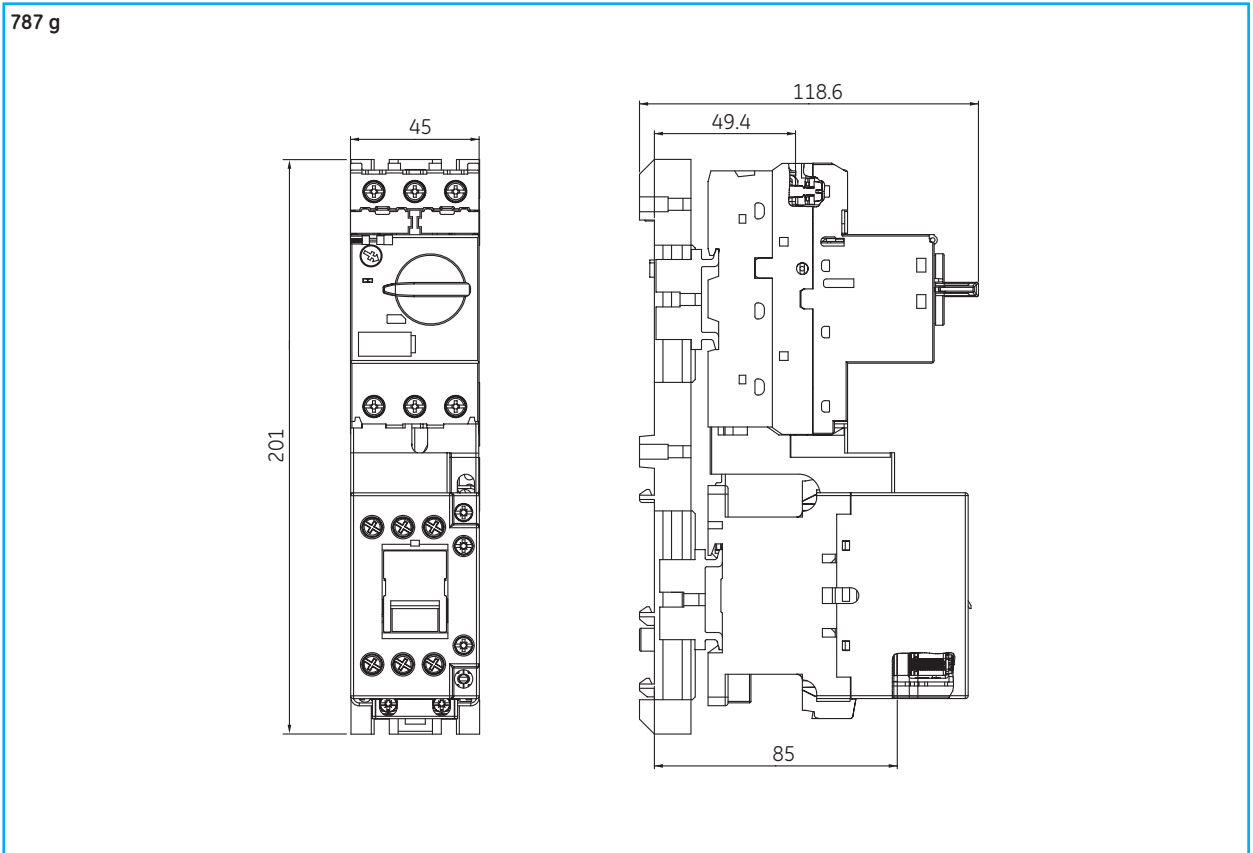

Starter combination of manual motor starter Surion GPS1 and contactor EC25A

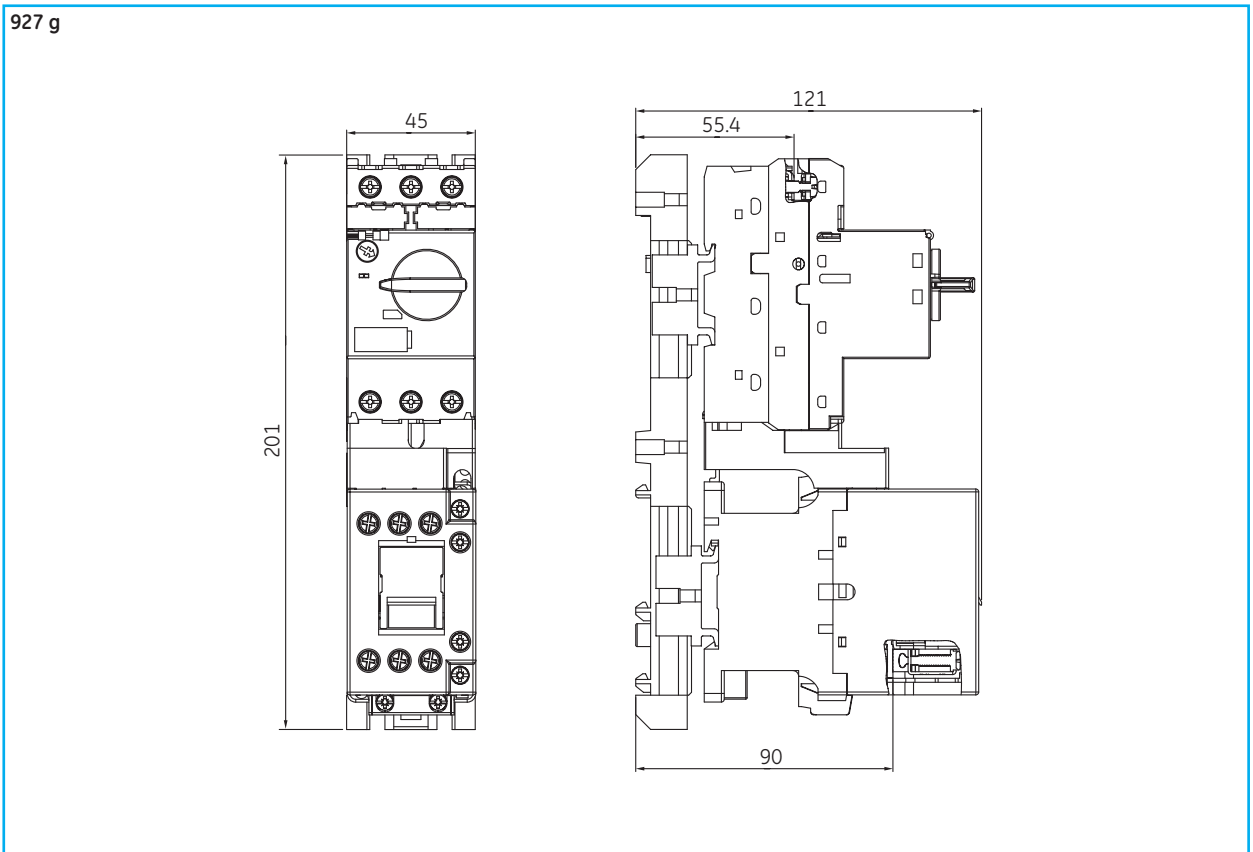

Starter combination of manual motor starter Surion GPS1 and contactor EC32A

967 g

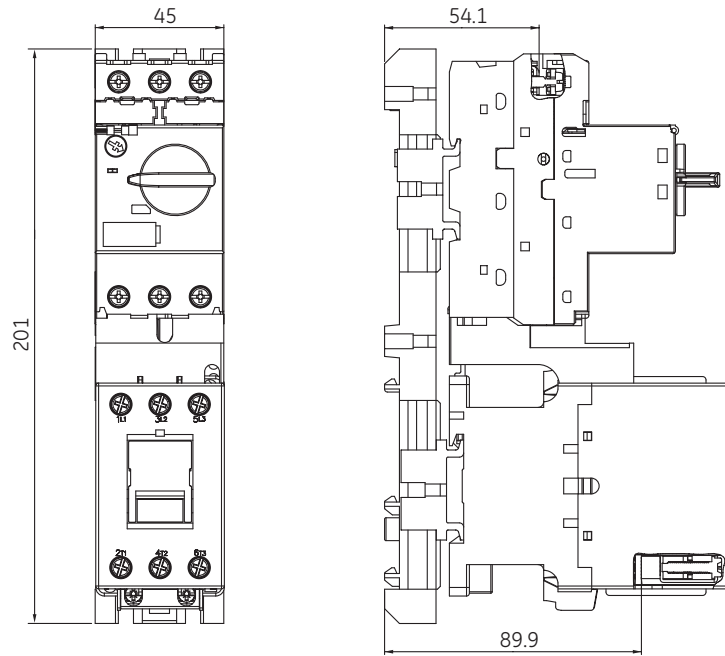

Technical data

Intro

A

B

C

D

E

F

G

H

I

J/X

Starter combination of manual motor starter Surion GPS2 and contactor EC40A

1368 g

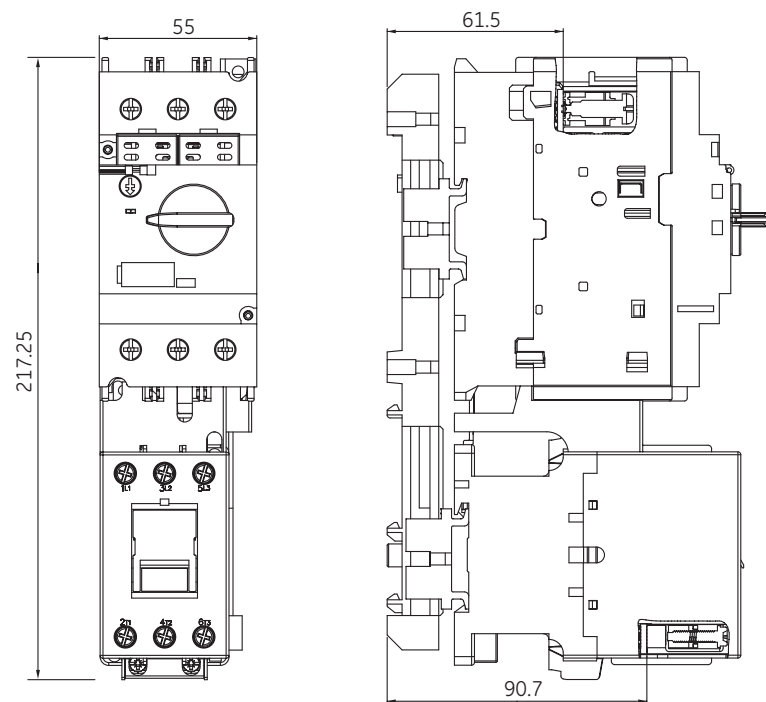

New



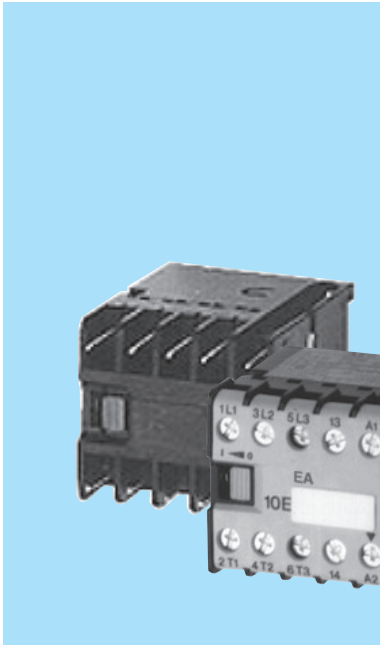

Three pole minicontactors 7A (AC3) 16A (AC1)

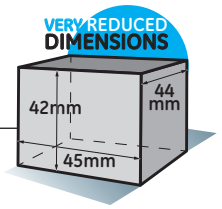

- Control circuit:
 - Alternating current up to 230VAC at 50/60Hz
 - Direct current up to 110VDC
- Low consumption:
 - Only 1.2 WDC
 - 2.4W In AC
- Power circuit: Up to 400VAC
- Rating:
 - 7.3A AC3 at 400V
 - 16A AC1
 - lth 16A
 - AC15: - 6A 230V
 - 4A 400V
- Motor rating AC-3 duty, 3 phases
 - 230V 1.5kW
 - 400/415V 3kW
- Very reduced dimensions: 42/45/44mm (HxWxD)
- Lateral carrier
- Terminal numbering in accordance with EN 50012
- Fixing by clipping onto 35mm DIN rail (EN 50022-35) or by screws
- Terminal versions:
 - Screws as standard
 - Solder pin for circuit board application
- Integrated one auxiliary contact block: 1NO or 1NC
- No accessories
 - No available additional auxiliary contacts
 - Stand-alone thermal protection

Standards

IEC/EN 60947-1
IEC/EN 60947-4-1
VDE 0660
BS5424

Approvals



UL

CSA

AC contactors



Power rating AC3 (kW)		Terminal	Poles	Auxiliary contacts		Control circuit	Voltage	Cat. no.	Ref. no.	Pack
230V	400V			NO	NC					
1.5	3	Screw	3	1	0	AC	24	EA07A310S024	247990	10
1.5	3	Screw	3	0	1	AC	24	EA07A301S024	247991	10
1.5	3	Screw	3	1	0	AC	48	EA07A310S048	247992	10
1.5	3	Screw	3	0	1	AC	48	EA07A301S048	247993	10
1.5	3	Screw	3	1	0	AC	110	EA07A310S110	247994	10
1.5	3	Screw	3	0	1	AC	110	EA07A301S110	247995	10
1.5	3	Screw	3	1	0	AC	230	EA07A310S230	247996	10
1.5	3	Screw	3	0	1	AC	230	EA07A301S230	247997	10
1.5	3	Screw	3	1	0	DC	24	EA07D310S024	247998	10
1.5	3	Screw	3	0	1	DC	24	EA07D301S024	247999	10
1.5	3	Screw	3	1	0	DC	110	EA07D310S110	248000	10
1.5	3	Screw	3	0	1	DC	110	EA07D301S110	248001	10
1.1	1.5	Solder pin	3	1	0	AC	24	EA07A310I024	248004	10
1.1	1.5	Solder pin	3	0	1	AC	24	EA07A301I024	248005	10
1.1	1.5	Solder pin	3	1	0	DC	48	EA07D310I048	248006	10
1.1	1.5	Solder pin	3	0	1	DC	48	EA07D301I048	248007	10
1.1	1.5	Solder pin	3	1	0	DC	110	EA07D310I110	248008	10
1.1	1.5	Solder pin	3	0	1	DC	110	EA07D301I110	248009	10
1.1	1.5	Solder pin	3	1	0	AC	230	EA07A310I230	248002	10
1.1	1.5	Solder pin	3	0	1	AC	230	EA07A301I230	248003	10

Order codes

Intro

A

B

C

D

E

F

G

H

I

NEW in 2013



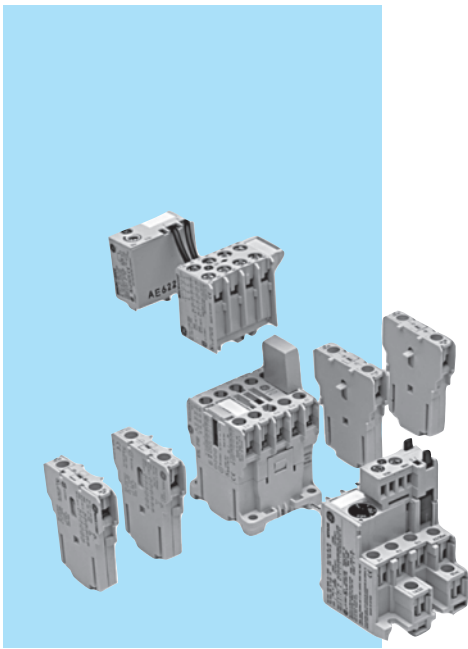

Three and four pole contactors 9 and 12A (AC3) 20A (AC1)

- Control circuit: Alternating current up to 600V
Direct current up to 440V
- Terminal numbering in accordance with EN 50012
- Fixing by clipping onto 35 mm DIN rail (EN 50022-35) or by screws
- Screws and fast-on terminals protected against accidental contact in accordance with VDE 0106 T.100 and VBG4
- Versions: Ring terminal and printed circuit terminals
- Facility to mount instant and timed auxiliary contact blocks and voltage suppressor block
- Degree of protection IP20 (EN 60529).
- Maximum number of auxiliary contacts to be added: 6

Standards

IEC/EN 60947-1	BS 4794
IEC/EN 60947-4-1	NFC 63-110
IEC/EN 60947-5-1	CSA C22.2/14
EN 50003	VDE 0660
EN 50005	SEV 10254
EN 50012	JIS C8325
UL 508	JEM 1038
NEMA ICS-1	CENELEC HD 419

General data

	MC1...	MC2...
Maximum number of poles	4	4
Rated thermal current (I_{th}) $\theta \leq 60^{\circ}\text{C}$ ⁽¹⁾	(A) 20	20
Rated operational current I_e ⁽²⁾ (3x440V, 50/60Hz, AC3)	(A) 9	12
Rated insulation current U_i	(V) 750	750
Rated operational current U_e	(V) 690	690

Approvals



Standard voltages

To complete the catalogue number, replace the symbol \blacklozenge by the code corresponding to the voltage and frequency of the control circuit (other voltages on request)

Alternating current (V). Bifrequency coil

\blacklozenge	10	1	2	9	3	4	5	6	7	8	12	13
AC	12	24	42	48	110	120	220	230	240	440	380	400
50/60Hz						115						

Operating voltages limits with bifrequency coils:

With 60Hz = 0.85 to 1.1 x U_s

With 50Hz = 0.8 to 1.1 x U_s in continuous service (ED=100%) with a maximum ambient temperature of 40°C

Alternating current (V).

\blacklozenge	A	E	G	K	M	N	S	U	W	Y
AC			48	115		220	260	380	415	500
50Hz				127		240		400	440	
AC	6	32	60		208	240		440	480	600
60Hz					220	277				

Direct current (V)

\blacklozenge	A	B	C	D	E	F	G	H	I	J	K	L	N	17	R	S	16
DC	6	12	32	24	36	42	48	60	72	110	120	125	220	230	240	250	440

Direct current (V) - Wide voltage range

\blacklozenge	WD	WE	WG	WI	WJ	WN
DC	24	33	48	72	110	220

- Order codes ● pg. A.45
- Auxiliary contact blocks ● pg. A.48
- Accessories ● pg. A.50
- Technical data ● pg. A.83
- Terminal numbering ● pg. A.89
- Dimensions ● pg. A.110



Three pole contactors

Max.operat.current Non-inductive loads AC1 ⁽²⁾ A	Motors <440V, 3~ 50/60Hz AC3 ⁽³⁾ A	Admissible power AC3						Aux. contacts		Control circuit: Alternating current		Control circuit: Direct current	
		1-phase 115V 220V		3-phase 220V 380V 500V 230V 400V				•3	•1	Cat. no. ⁽¹⁾	Pack	Cat. no. ⁽¹⁾	Pack
		kW HP	kW HP	kW HP	kW HP	kW HP	kW HP	•4	•2	Ref. no. see bottom		Ref. no. see bottom	
Terminal: screw													
20	9	0.56	1.12	2.2	4	4		1	0	MC1A310AT ♦	20	MC1C310AT ♦	10
		0.75	1.5	3	5.5	5.5		0	1	MC1A301AT ♦	20	MC1C301AT ♦	10
20	12	0.75	2	3	5.5	5.5		1	0	MC2A310AT ♦	20	MC2C310AT ♦	10
		1	2.6	4	7.3	7.3		0	1	MC2A301AT ♦	20	MC2C301AT ♦	10
Terminal: ring terminal													
20	9	0.56	1.12	2.2	4	4		1	0	MC1A310AR ♦	20	MC1C310AR ♦	10
		0.75	1.5	3	5.5	5.5		0	1	MC1A301AR ♦	20	MC1C301AR ♦	10
20	12	0.75	2	3	5.5	5.5		1	0	MC2A310AR ♦	20	MC2C310AR ♦	10
		1	2.6	4	7.3	7.3		0	1	MC2A301AR ♦	20	MC2C301AR ♦	10
Terminal: faston 2x2.8 insulated (5)													
16 ⁽⁴⁾	9	0.56	1.12	2.2	4	4		1	0	MC1A310AF ♦	20	MC1C310AF ♦	10
		0.75	1.5	3	5.5	5.5		0	1	MC1A301AF ♦	20	MC1C301AF ♦	10
Terminal: printed circuit													
20	9	0.56	1.12	2.2	4	4		1	0	MC1A310AI ♦	20	MC1C310AI ♦	10
		0.75	1.5	3	5.5	5.5		0	1	MC1A301AI ♦	20	MC1C301AI ♦	10
20	12	0.75	2	3	5.5	5.5		1	0	MC2A310AI ♦	20	MC2C310AI ♦	10
		1	2.6	4	7.3	7.3		0	1	MC2A301AI ♦	20	MC2C301AI ♦	10
Spare coil										MB0A ♦	10	MB0C ♦	10



- (1) To complete the catalogue number, replace the symbol ♦ by the code corresponding to the voltage and frequency of the control circuit (other voltages on request) (see A.44)
- (2) Electrical endurance AC-1: MC1... 0.3 x 10⁶ operations
MC2... 0.35 x 10⁶ operations
- (3) Electrical endurance AC-3: MC1... (9A) = 0.85 x 10⁶ operations
MC2... (12A) = 0.6 x 10⁶ operations
- (4) Terminal with wire 1.5 mm²: I_e = 16A
with wire 1 mm²: I_e = 10A
Insulated terminal type B 2.8 x 0.8 and wire 1 mm² I_e = 8A in accordance with DIN 46247.
- (5) Fast-on 1 x 6.3 terminals on request (replace letter F by H in the catalogue number)

For reference numbers, see chapter X, pg. X.2



Order codes

Intro

A

B

C

D

E

F

G

H

I

J/X

Three pole interface contactors

Max. oper. current Non-inductive load AC1 A	Motors <440V, 3 ~ 50/60Hz AC3 ⁽³⁾ A	Admissible power AC3					Aux. contacts		Voltage 24V D.C, coil 1.2W ⁽¹⁾			Voltage 24V D.C, coil 2W ⁽²⁾		
		1-phase		3-phase			•3 •4	•1 •2	Cat. no. ⁽¹⁾	Ref. no.	Pack	Cat. no. ⁽¹⁾	Ref. no.	Pack
		115V	220V	220V	380V	500V								
		kW	kW	kW	kW	kW								
Terminal: screw														
20	9	0.56	1.12	2.2	4	4	1	0	MC1I310ATD	100572	10	MC1K310ATD	100576	10
							0	1	MC1I301ATD	100573	10	MC1K301ATD	100577	10
20	12	0.75	2	3	5.5	5.5	1	0	MC2I310ATD	100559	10	MC2K310ATD	103590	10
							0	1	MC2I301ATD	100538	10	MC2K301ATD	103591	10
Spare coil									MB0ID	100470	10	MB0KD	100471	10

- (1) No possibility of adding instantaneous auxiliary contact blocks.
- (2) Facility to mount an instantaneous auxiliary contact block of two contacts or two instantaneous auxiliary contact blocks of one contact.
- (3) Electrical endurance AC-3:
 - MC0... (6A) = 1.2×10^6 operations.
 - MC1... (9A) = 0.85×10^6 operations.
 - MC2... (12A) = 0.6×10^6 operations.

Multipack. Series M

To reduce the amount of waste packaging material and to save time during installation, we offer the opportunity to order contactors in a multipack without the individual packaging.

Product	Type	Standard pack	Multipack (1)
Contactors	MC1...MC2a	20	40

(1) The quantity ordered must be a multiple of the quantity in each multipack (with the same frame/size and coil voltage)

How to order

To order a multipack, add the suffix **MP** to the standard catalogue number

Example	Standard pack	Multipack
	MCOA310ATN	MCOA310ATN MP (40 pieces)

Four poles contactors

Max.oper.current Non- inductive load	Motors <440V, 3 ~ 50/60Hz AC3 ⁽³⁾ A	Admissible power AC3					Poles		Control circuit: Alternating current		Control circuit: Direct current			
		1-phase		3-phase			4	0	Cat. no. ⁽¹⁾	Pack	Cat. no. ⁽¹⁾	Pack		
		115V	220V	220V	380V	500V							Ref. no. see bottom	Ref. no. see bottom
AC1 ⁽²⁾ A	AC3 ⁽³⁾ A	kW HP	kW HP	kW HP	kW HP	kW HP	2	2	0	4	MC1A400AT ♦	20	MC1C400AT ♦	10
Screw terminal														
20	9	AC1					4	0	MC1A400AT ♦	20	MC1C400AT ♦	10		
		2.3	4.4	7.5	13	17	2	2	MC1AB00AT ♦	20	MC1CB00AT ♦	10		
		-	-	-	-	-	0	4	MC1AA00AT ♦	20				
AC3					0.56	1.12	2.2	4	4					
		0.75	1.5	3	5.5	5.5								
20	12	AC1					4	0	MC2A400AT ♦	20	MC2C400AT ♦	10		
		2.3	4.4	7.5	13	17	2	2	MC2AB00AT ♦	20	MC2CB00AT ♦	10		
		-	-	-	-	-								
AC3					0.75	2	3	5.5	5.5					
		1	2.6	4	7.3	7.3								
Terminal: faston 2x2.8 insulated (5)														
16 ⁽⁴⁾	9	AC1					4	0	MC1A400AF ♦	20	MC1C400AF ♦	10		
		2.3	4.4	7.5	13	17	2	2	MC1AB00AF ♦	20	MC1CB00AF ♦	10		
		-	-	-	-	-	0	4	MC1AA00AF ♦	20				
AC3					0.56	1.12	2.2	4	4					
		0.75	1.5	3	5.5	5.5								
Terminal: printed circuit														
20	9	AC1					4	0	MC1A400AI ♦	20	MC1C400AI ♦	10		
		2.3	4.4	7.5	13	17	2	2	MC1AB00AI ♦	20	MC1CB00AI ♦	10		
		-	-	-	-	-	0	4	MC1AA00AI ♦	20				
AC3					0.56	1.12	2.2	4	4					
		0.75	1.5	3	5.5	5.5								

Spare coil

MBOA ♦ 10 MBOC ♦ 10

(1) To complete the catalogue number, replace the symbol ♦ by the code corresponding to the voltage and frequency of the control circuit (see A.44)

(2) Electrical endurance AC-1: MC1... 0.3 × 10⁶ operations
MC2... 0.35 × 10⁶ operations(3) Electrical endurance AC-3: MC1... (9A) = 0.85 × 10⁶ operations
MC2... (12A) = 0.6 × 10⁶ operations(4) Terminal with wire 1.5 mm²: I_e = 16A
with wire 1 mm²: I_e = 10AInsulated terminal type B 2.8 × 0.8 and wire of 1 mm² I_e = 8A in accordance with DIN 46247.

(5) Faston 1 × 6.3 terminals on request, (replace letter F by H in the catalogue number).

For reference numbers,
see chapter X, pg. X.2

Instantaneous auxiliary contact blocks

Front mounting

Number contacts	Combinations with basic contactor 10E	Contacts in acc. with EN 50012	Contacts in acc. with EN 50005	Aux. contacts		Cat. no.	Ref. no.	Pack
				•3 •4	•1 •2			
<ul style="list-style-type: none"> Two or four additional contacts, to cover combinations of 3 or 5 contacts without increasing the surface area of the basic contactor 								
Screw terminal								
2	21E	11		1	1	MACN211AT	100999	10
2	12E	02		0	2	MACN202AT	100998	10
2			20	2	0	MARN220AT	100994	10
2			11	1	1	MARN211AT	100993	10
2			02	0	2	MARN202AT	100992	10
4	41E	31		3	1	MACN431AT	100997	10
4	32E	22		2	2	MACN422AT	100996	10
4	23E	13		1	3	MACN413AT	100995	10
4			40	4	0	MARN440AT	100991	10
4			31	3	1	MARN431AT	100990	10
4			22	2	2	MARN422AT	100989	10
4			13	1	3	MARN413AT	100988	10
4			04	0	4	MARN404AT	100987	10
Ring terminal								
2	21E	11		1	1	MACN211AR	103557	10
2	12E	02		0	2	MACN202AR	103558	10
2			20	2	0	MARN220AR	103349	10
2			11	1	1	MARN211AR	103350	10
2			02	0	2	MARN202AR	103351	10
4	41E	31		3	1	MACN431AR	103559	10
4	32E	22		2	2	MACN422AR	103560	10
4	23E	13		1	3	MACN413AR	103561	10
4			40	4	0	MARN440AR	103352	10
4			31	3	1	MARN431AR	103353	10
4			22	2	2	MARN422AR	103354	10
4			13	1	3	MARN413AR	103355	10
4			04	0	4	MARN404AR	103300	10



Instantaneous auxiliary contact blocks (continued)

Lateral mounting



Number contacts	Combinations with basic contactor 10E	Contacts in acc. with EN 50012	Contacts in acc. with EN 50005	Aux. contacts		Cat. no.	Ref. no.	Pack
				•3	•1			
				•4	•2			

• One or two additional blocks, to cover combinations of 1 or 2 contacts without increasing the height of the basic unit contactor

Screw terminal								
1	20	10		1	0	MACL110AT	100560	10
1	11E	01		0	1	MACL101AT	100561	10

Ring terminal								
1	20	10		1	0	MACL110AR	103555	10
1	11E	01		0	1	MACL101AR	103556	10

Terminal: faston 2x2.8 insulated (1)								
1	20	10		1	0	MACL110AF	100562	10
1	11E	01		0	1	MACL101AF	100563	10

Terminal: printed circuit								
1	20	10		1	0	MACL110AI	100564	10
1	11E	01		0	1	MACL101AI	100565	10

- One or two additional blocks, when up to 6 or 7 contacts are needed (combination possible with frontal blocks)
- One or two additional blocks on both sides, to cover up to five contacts (combination possible only with lateral blocks)

Screw terminal								
1			10	1	0	MARL110ATS	100519	10
1			01	0	1	MARL101ATS	100520	10

Ring terminal								
1			10	1	0	MARL110ARS	103299	10
1			01	0	1	MARL101ARS	103298	10



Terminal: faston 2x2.8 insulated (1)								
1			10	1	0	MARL110AFS	100521	10
1			01	0	1	MARL101AFS	100522	10

Terminal: printed circuit								
1			10	1	0	MARL110AIS	100523	10
1			01	0	1	MARL101AIS	100524	10

(1) Terminal with wire 1 mm²: Ie = 10A
Insulated terminal type B 2.8 x 0.8 with wire 1 mm²: Ie = 8A, in accordance with DIN 46247



Accessories

	For use with:	Time	Function	Ue	Cat. no.	Ref. no.	Pack
 <p>Electronic timer block</p>	Lateral or front fixing to the contactor						
	MCR..MC_ ...	0.5 - 60 seg.	delay ON	24... 250V AC/DC	MREBC10AC2	100541	10
	MCR..MC_ ...	0.2 - 24 seg.	delay ON	24...250V AC/DC	MREBC20AC2	100542	10
 <p>DIN rail adaptor for electronic timer block</p>	For fixing onto EN 50022-35						
	MREBC...				MVBOR	100543	10

	For use with:	Type	Control	Ue	Cat. no.	Ref. no.	Pack
 <p>Voltage suppressor block</p>	Connection and (plug-in) fixing on to the connector						
	MCRA,MC_ ...	R/C	AC	12...60V 50/60Hz	MP0AAE1	100544	10
	MCRA,MC_ ...	R/C	AC	72... 250V 50/60Hz	MP0AAE2	100545	10
	MCRC,MC_ ...	Diode	DC	6...250V DC	MP0CAE3	100546	10
	MCRC,MC_ ...	Varistor	AC/DC	24-48V	MP0DAE4	100536	10

	For use with:	Phases	Terminal capacity	Ue	Cat. no.	Ref. no.	Pack
 <p>Pole paralleling links</p>	To connect two, three or four phases in parallel						
	MC_ ...	2, 3, 4 (parallel)	Ø4.5mm - 16mm ²		MVPOC	100600	10

	For use with:	Cat. no.	Ref. no.	Pack
 <p>Mechanical interlock</p>	Mechanical interlock and pole jumpers			
	MCR, MC_ ...	MMHO	100547	10

	For use with:	Cat. no.	Ref. no.	Pack
<p>Identification</p>	Mechanical interlock and pole jumpers			
	MCR, MC_ ...	EAT 260	100548	1
	MCR, MC_ ...	SPR	100549	1

Intro

A

B

C

D

E

F

G

H

I

J/X



Direct-on-line starters

6 to 12A (AC-3)

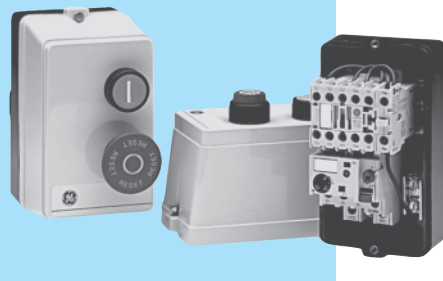

- Power circuit: up to 690V AC
- Control circuit: up to 600V AC
- Polycarbonate enclosure (IP40 - IP65)
 - Shock resistance
 - Total insulation \square
 - 4 knock-out input holes PG13.5
 - Cable entry in the base
- Terminals protected against accidental contact
- 16 setting ranges from 0.11 up to 14A
- Start contact block

Series M - Direct-on-line starters

	Push-buttons	Protection degree	Cat. no.	Ref. no	Pack
Empty boxes	Start/Stop + Reset	IP40	MG0004PATO	209780	1
		IP65	MG0006PATO	209781	1
	Reset only	IP40	MG0004RATO	137567	1
		IP65	MG0006RATO	116402	1
	Start/Emergency stop	IP40	MG0004QATO	137566	1
		IP65	MG0006QATO	116074	1
Start contact block	Laterally mounted to the contactor, allowing the electrical operation the box push-button which incises on it.		MAGL110AT	100608	1

Reversing starters

6 to 12A (AC-3)

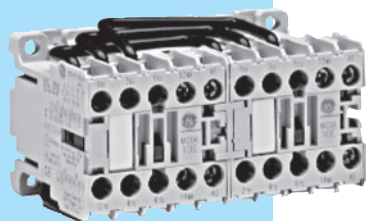

- Power circuit: up to 690V AC
- Control circuit: up to 600V AC
up to 250V DC
- Assembled versions on request.
- Screw and push-on terminals protected against accidental contact.
- Protection degree IP20 in accordance with EN 60529.
- Facility to mount instant and timed auxiliary contact blocks and voltage suppressor blocks.

Series M - Reversing starters

	Description	For use with contactor	ac/dc	Cat. no.	Ref. no.	Pack.
Wiring kits for reversing starters	Suitable to be used with link modules	MC1..., MC2...	ac/dc	WKMIU	101421	1
	Upper and lower connections without overload relays					

Wiring diagrams ● page A.134
Dimensions ● page A.137

Order codes

Intro

A

B

C

D

E

F

G

H

I

J/X



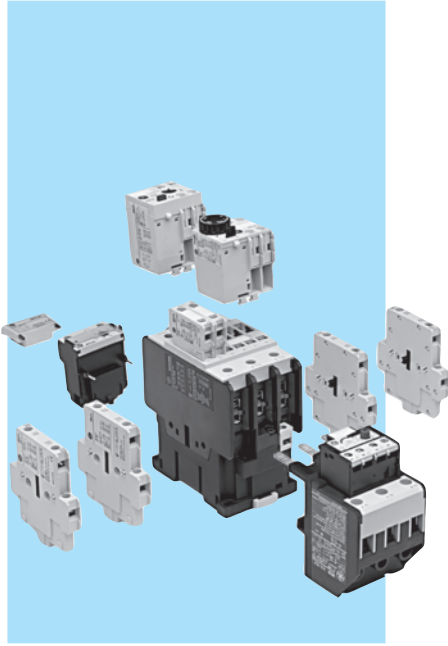

Three and four pole contactors 9 to 105A (AC3) 25 to 140A (AC1)

- Control circuit: Alternating current up to 690V
Direct current up to 440V
- Terminal numbering in accordance with EN 50005 and EN 50012
- Fixing by clipping onto 35mm DIN rail EN 50022-35 or by screws
- Screws protected against accidental contact in accordance with VDE 0106 T.100, VBG4.
- Ring terminal version
- Three coil terminals
- Mounting possibilities of front/side instantaneous auxiliary contact blocks, timed auxiliary contact blocks, mechanical latch, transient suppressor block and interface modules.
- Degree of protection: IP20 to CL00 ... CL02
IP10 to CL25 ... CL10
- Maximum number of auxiliary contacts: 4 for CL00 ... CL25
6 for CL04 ... CL45
8 for CL06 ... CL10

Standards

IEC/EN 60947-1	CSA 22.2/14
IEC/EN 60947-4-1	NFC 63-110
IEC/EN 60947-5-1	ASE 1025
EN 50005	VDE 0660/102
UL 508	CENELEC HD 419
NEMA ICS 1	
BS 5424 & 775	

Standard voltages

To complete the catalogue number, replace the symbol \blacklozenge by the code corresponding to the voltage and frequency of the control circuit.

Alternating current (V). Dual-frequency coil

\blacklozenge	1	2	9	3	4	5	6	7	13	8	15
AC	24	42	48	110	120	220	230	240	400	440	480
50/60Hz				115							

Alternating current (V).

\blacklozenge	E	K	L	N	T	U	W	Y	Z
AC	32	127		220		380	415	500	660
50Hz				230		400		690	
AC			208	277	380	480	460	600	
60Hz									

Direct current (V)

For contactors type CL...D / Operating limits: 0.80 ... 1.10 x Us

\blacklozenge	B	D	E	F	G	H	I	J	K	N	P	R	T	X
Voltage	12	24	36	42	48	60	72	110	120	220	230	240	250	440
										125				

Coil with electronic module for contactors CL...E (can also be used with alternating current)

\blacklozenge	D	F	H	J	N	Y
Voltage	24	42	60	110	220	440
	28	48	72	125	250	

Direct current (V). Coil with wide voltage range (0.70 ... 1.30 x Us)

For contactors type CL...D

\blacklozenge	WB	WD	WE	WF	WG	WH	WI	WJ	WK	WN	WP	WR	WT	WX
DC	12	24	33	42	48	60	72	110	125	220	230	240	250	440

Maximum number of add-on auxiliary contact blocks:

CL00D...CL02D : 2NO or 1NC
CL03D...CL45D : 1NO and 1NC
CL05D...CL10D : 4NO or 2NC
CL05E...CL10E : 4 cont. aux.

Coil with electronic module for contactors CL...E

\blacklozenge	WD	WE	WF	WH	WJ	WN
Voltage	24	33	48	72	110	220

Different auxiliary contact configurations, contact us.

Approvals



cULus



IMQ
(up to Ith=32A)



RINA



Lloyd's Register



Bureau Veritas



CE



(Contact GE for details)

- Order codes ● pg. A.53
- Auxiliary contact blocks ● pg. A.57
- Accessories ● pg. A.58
- Technical data ● pg. A.91
- Terminal numbering ● pg. A.99
- Dimensions ● pg. A.112

Three pole contactors. Screw terminal

Max.oper.current Non-inductive load AC1 A	Motors <440V, 3 ~ 50/60Hz AC3 A	Admissible power AC3				Electrical endurance Cat. AC3 Operations	Aux. contacts		Control circuit: Alternating current		Control circuit: Direct current		Control circuit: Coil with electronic module (AC/DC)	
		220V 230V	380V 400V	415V 440V	500V 440V		•3	•1	Cat. no. (1)	Pack (3)	Cat. no. (1)	Pack (3)	Cat. no. (1)	Pack (3)
		kW HP	kW HP	kW HP	kW HP		•4	•2	Ref. no. see bottom		Ref. no. see bottom		Ref. no. see bottom	
25	9	2.2 3	4 5.5	4 5.5	5.5 7.5	2x10 ⁶	1 0	0 0	CL00A310T♦ CL00A301T♦	5 5	CL00D310T♦ CL00D301T♦	10 10	- -	- -
25	12	3 4	5.5 7.5	5.5 7.5	7.5 10	2x10 ⁶	1 0	0 1	CL01A310T♦ CL01A301T♦	5 5	CL01D310T♦ CL01D301T♦	10 10	- -	- -
32	18	4 5.5	7.5 10	7.5 10	10 13.5	1.7x10 ⁶	1 0	0 1	CL02A310T♦ CL02A301T♦	5 5	CL02D310T♦ CL02D301T♦	10 10	- -	- -
45	25	7.5 10	11 15	11 15	15 20	1.2x10 ⁶	0 0	0 0	CL25A300T♦	5	CL25D300T♦	10	-	-
45	25	7.5 10	12 16	12 16	15 20	2x10 ⁶	1 0	0 1	CL03A310M♦ CL03A301M♦	10 10	CL03D310M♦ CL03D301M♦	10 10	- -	- -
60	32	9 12	16 22	16 22	18.5 25	2x10 ⁶	1 0	0 1	CL04A310M♦ CL04A301M♦	10 10	CL04D310M♦ CL04D301M♦	10 10	- -	- -
60	40	11 15	18.5 25	22 30	25 34	2x10 ⁶	0 0	0 0	CL45A300M♦	10	CL45D300M♦	10	-	-
90	50	15 20	22 30	25 34	30 40	1.8x10 ⁶	0 0	0 0	CL06A300M♦	1	CL06D300M♦	1	CL06E300M♦	1
110	65	18.5 25	30 40	37 50	40 55	1.7x10 ⁶	0 0	0 0	CL07A300M♦	1	CL07D300M♦	1	CL07E300M♦	1
110	80	22 30	37 50	45 60	45 60	1.5x10 ⁶	0 0	0 0	CL08A300M♦	1	CL08D300M♦	1	CL08E300M♦	1
140	95	25 34	45 60	50 68	55 75	1.7x10 ⁶	0 0	0 0	CL09A300M♦	1	CL09D300M♦	1	CL09E300M♦	1
140	105	30 40	55 75	55 75	65 88	1.5x10 ⁶	0 0	0 0	CL10A300M♦	1	CL10D300M♦	1	CL10E300M♦	1
Spare coils						CL00 - CL25			LB1A ♦	5	LB1D ♦	5	-	-
						CL03 - CL45			LB3A ♦	5	LB3D ♦	5	-	-
						CL06 - CL10			LB4A ♦	5	LB4D ♦	1	-	-
						coil + electronic module							LB4E ♦	1

- (1) To complete the catalogue number, replace the symbol ♦ by the code corresponding to the voltage and frequency of the control circuit (see A.52).
- (2) Equipped with two blocks BCLF
- (3) Multipack, see below

Multipack. Series M and Series CL

To reduce the amount of waste packaging material and to save time during installation, we offer the opportunity to order contactors in a multipack without the individual packaging.

Product	Type	Standard pack	Multipack (1)
Contactors	CL00A...CL25A...	20	40
	CL03...CL45...	10	20

(1) The quantity ordered must be a multiple of the quantity in each multipack (with the same frame/size and coil voltage)

How to order

For reference numbers, see chapter X, pg. X.4

To order a multipack, add the suffix **MP** to the standard catalogue number

Example	Standard pack	Multipack
	CL03A400MJ	CL03A400MJ MP (20 pieces)



Order codes

Intro

A

B

C

D

E

F

G

H

I

J/X

Three pole contactors. Ring terminal

Contactors



AC1 A	Max.oper.current Non-inductive load Motors <440V, 3~ 50/60Hz AC3 A	Admissible power AC3				Electrical endurance Cat. AC3 Operations	Aux. contacts		Control circuit: Alternating current		Control circuit: Direct current	
		220V 230V	380V 400V	415V 440V	500V		•3 •4	•1 •2	Cat. no. (1)	Pack (2)	Cat. no. (1)	Pack (2)
25	9	2.2 3	4 5.5	4 5.5	5.5 7.5	2x10 ⁶	1 0	0 1	CL00A310R♦ CL00A301R♦	5 5	CL00D310R♦ CL00D301R♦	10 10
25	12	3 4	5.5 7.5	5.5 7.5	7.5 10	2x10 ⁶	1 0	0 1	CL01A310R♦ CL01A301R♦	5 5	CL01D310R♦ CL01D301R♦	10 10
32	18	4 5.5	7.5 10	7.5 10	10 13.5	1.7x10 ⁶	1 0	0 1	CL02A310R♦ CL02A301R♦	5 5	CL02D310R♦ CL02D301R♦	10 10
45	25	7.5 10	11 15	11 15	15 20	1.2x10 ⁶	0 0	0 0	CL25A300R♦	5	CL25D300R♦	10
45	25	7.5 10	12 16	12 16	15 20	2x10 ⁶	1 0	0 1	CL03A310R♦ CL03A301R♦	10 10	CL03D310R♦ CL03D301R♦	10 10
60	32	9 12	16 22	16 22	18.5 25	2x10 ⁶	1 0	0 1	CL04A310R♦ CL04A301R♦	10 10	CL04D310R♦ CL04D301R♦	10 10
60	40	11 15	18.5 25	22 30	25 34	2x10 ⁶	0 0	0 0	CL45A300R♦	10	CL45D300R♦	10
90	50	15 20	22 30	25 34	30 40	1.8x10 ⁶	0 0	0 0	CL06A300R♦	1	CL06D300R♦	1
110	65	18.5 25	30 40	37 50	40 55	1.7x10 ⁶	0 0	0 0	CL07A300R♦	1	CL07D300R♦	1
110	80	22 30	37 50	45 60	45 60	1.5x10 ⁶	0 0	0 0	CL08A300R♦	1	CL08D300R♦	1
140	95	25 34	45 60	50 68	55 75	1.7x10 ⁶	0 0	0 0	CL09A300R♦	1	CL09D300R♦	1
140	105	30 40	55 75	55 75	65 88	1.5x10 ⁶	0 0	0 0	CL10A300R♦	1	CL10D300R♦	1

Spare coils

CL00 - CL25	LB1A ♦	5	LB1D ♦	5
CL03 - CL45	LB3A ♦	5	LB3D ♦	5
CL06 - CL10	LB4A ♦	5	LB4D ♦	1

(1) To complete the catalogue number, replace the symbol ♦ by the code corresponding to the voltage and frequency of the control circuit (see A.52).

(2) Multipack, see A.53

For reference numbers, see chapter X, pg. X.4



Four pole contactors. Screw terminal



Max.oper.current Non-inductive loads		Admissible power AC1				Electrical endurance Cat. AC1 Operations	Power contacts		Control circuit: Alternating current		Control circuit: Direct current		Control circuit: Coil with electronic module (AC/DC)	
AC1 A	AC3 A	220V 230V	380V 400V	415V 440V	500V		C	/	Cat. no. ⁽¹⁾	Pack ⁽²⁾	Cat. no. ⁽¹⁾	Pack ⁽²⁾	Cat. no. ⁽¹⁾	Pack ⁽²⁾
		kW	kW	kW	kW					Ref. no. see bottom		Ref. no. see bottom		Ref. no. see bottom
25	12	9.5	16.5	18	21.5	1.5x10 ⁶	4 0	CL01A400T♦	5	CL01D400T♦	10	-	-	-
32	18	12	22	23	27.5	1.5x10 ⁶	4 0	CL02A400T♦	5	CL02D400T♦	10	-	-	-
45	25	17	29	32	39	2x10 ⁶	4 0	CL03A400M♦	10	CL03D400M♦	10	-	-	-
60	32	22.5	39.5	43	52	1.5x10 ⁶	4 0	CL04A400M♦	10	CL04D400M♦	10	-	CL05E400M♦	1
90	50	34	59	64	78	1.5x10 ⁶	4 0	CL05A400M♦	1	CL05D400M♦	1	-	CL07E400M♦	1
110	65	42	72.5	79	95	1.8x10 ⁶	4 0	CL07A400M♦	1	CL07D400M♦	1	-	CL09E400M♦	1
140	95	53	92	100	121	1.8x10 ⁶	4 0	CL09A400M♦	1	CL09D400M♦	1	-	-	-



Max.oper.current Non-inductive loads		Admissible power AC3				Electrical endurance Cat. AC3 Operations	Power contacts		Control circuit: Alternating current		Control circuit: Direct current		Control circuit: Coil with electronic module (AC/DC)	
AC1 A	Motors <440V, 3~ 50/60Hz AC3 A	220V 230V	380V 400V	415V 440V	500V		C	/	Cat. no. ⁽¹⁾	Pack ⁽²⁾	Cat. no. ⁽¹⁾	Pack ⁽²⁾	Cat. no. ⁽¹⁾	Pack ⁽²⁾
		kW HP	kW HP	kW HP	kW HP					Ref. no. see bottom		Ref. no. see bottom		Ref. no. see bottom
25	12	3 4	5.5 7.5	5.5 7.5	7.5 10	2x10 ⁶	2 2	CL01AB00T♦	5	CL01DB00T♦	5	-	-	-
32	18	4 5.5	7.5 10	7.5 10	10 13.5	2x10 ⁶	2 2	CL02AB00T♦	5	CL02DB00T♦	5	-	-	-
45	25	7.5 10	12 16	12 16	15 20	2x10 ⁶	2 2	CL03AB00M♦	10	CL03DB00M♦	10	-	-	-
60	32	9 12	16 22	16 22	18.5 25	2x10 ⁶	2 2	CL04AB00M♦	10	CL04DB00M♦	10	-	-	-
90	40	11 15	18.5 25	22 30	25 34	2x10 ⁶	2 2	CL05AB00M♦	1	CL05DB00M♦	1	CL05EB00M♦	1	1
110	65	18.5 25	30 40	37 50	40 55	2x10 ⁶	2 2	CL07AB00M♦	1	CL07DB00M♦	1	CL07EB00M♦	1	1
110	80	22 30	37 50	45 60	45 60	2x10 ⁶	2 2	CL08AB00M♦	1	CL08DB00M♦	1	CL08EB00M♦	1	1



Spare coils	Model	Cat. no. ⁽¹⁾	Pack ⁽²⁾	Cat. no. ⁽¹⁾	Pack ⁽²⁾	Cat. no. ⁽¹⁾	Pack ⁽²⁾
	CL00 - CL25	LB1A ♦	5	LB1D ♦	5	-	-
	CL03 - CL45	LB3A ♦	5	LB3D ♦	5	-	-
	CL05A - CL08A	LB4A ♦	5	LB4D ♦	1	-	-
	Coil + Electronic module CL05E - CL08E	LB4E ♦	1	-	-	LB4E ♦	1

(1) To complete the catalogue number, replace the symbol ♦ by the code corresponding to the voltage and frequency of the control circuit (see A.52).
 (2) Multipack, see A.53

For reference numbers, see chapter X, pg. X.4



Four poles. Ring terminal

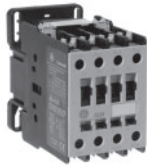

Max.oper.current Non-inductive load		Admissible power AC1				Electrical endurance	Power contacts	Control circuit: Alternating current		Control circuit: Direct current		
AC1 A	AC3 A	220V 230V	380V 400V	415V 440V	500V			Cat. AC1 Operations	Cat. no. ⁽¹⁾	Pack ⁽²⁾	Cat. no. ⁽¹⁾	Pack ⁽²⁾
25	12	9.5	16.5	18	21.5	1.5x10 ⁶	4	0	CL01A400R♦	5	CL01D400R♦	10
32	18	12	22	23	27.5	1.5x10 ⁶	4	0	CL02A400R♦	5	CL02D400R♦	10
45	25	17	29	32	39	2x10 ⁶	4	0	CL03A400R♦	10	CL03D400R♦	10
60	32	22.5	39.5	43	52	1.5x10 ⁶	4	0	CL04A400R♦	10	CL04D400R♦	10
90	50	34	59	64	78	1.5x10 ⁶	4	0	CL05A400R♦	1	CL05D400R♦	1
110	65	42	72.5	79	95	1.8x10 ⁶	4	0	CL07A400R♦	1	CL07D400R♦	1
140	95	53	92	100	121	1.8x10 ⁶	4	0	CL09A400R♦	1	CL09D400R♦	1

Max.oper.current Non-inductive load		Admissible power AC3				Electrical endurance	Power contacts	Control circuit: Alternating current		Control circuit: Direct current	
AC1 A	Motors <440V, 3~ 50/60Hz AC3 A	220V 230V	380V 400V	415V 440V	500V			Cat. no. ⁽¹⁾	Pack ⁽²⁾	Cat. no. ⁽¹⁾	Pack ⁽²⁾
25	12	3 4	5.5 7.5	5.5 7.5	7.5 10	2	2	CL01AB00R♦	5	CL01DB00R♦	5
32	18	4 5.5	7.5 10	7.5 10	10 13.5	2	2	CL02AB00R♦	5	CL02DB00R♦	5
45	25	7.5 10	12 16	12 16	15 20	2	2	CL03AB00R♦	10	CL03DB00R♦	10
60	32	9 12	16 22	16 22	18.5 25	2	2	CL04AB00R♦	10	CL04DB00R♦	10

Spare coils





CL00 - CL25	LR1A ♦	5	LR1D ♦	5
CL03 - CL45	LR3A ♦	5	LR3D ♦	5
CL05A - CL08A	LR4A ♦	5	LR4D ♦	1



(1) To complete the catalogue number, replace the symbol ♦ by the code corresponding to the voltage and frequency of the control circuit (see A.52).
 (2) Multipack, see A.53



Auxiliary contact blocks

Instantaneous		Number of contacts	Contacts				Type	Time	Cat. no.	Ref. no.	Pack				
	Frontal mounting	Terminal: screw	•3	•1	•7	•5									
			•4	•2	•8	•6									
			1	1	0	0						0	BCLF10	104700	10
			1	0	1	0						0	BCLF01	104701	10
			1	0	0	1						0	BCLF10G	104702	10
	1	0	0	0	1	BCLF01G	104703	10							
	Side mounting	Terminal: ring terminal	1	1	0	0	0	BCRF10	108901	10					
			1	0	1	0	0	BCRF01	108902	10					
			For combinations of more than 4 front-mounted and 2 side-mounted auxiliary contact blocks												
			2	2	0	0	0	BRLL20	104704	10					
2			1	1	0	0	BRLL11	104705	10						
2	0	2	0	0	BRLL02	106622	10								
Pneumatic timer															
	Front mounting	Terminal: screw	2	0	0	1	1	Delay ON	0.1 - 30 sec.	BTLF30C	104709	10			
			2	0	0	1	1	Delay ON	1 - 60 sec.	BTLF60C	104710	10			
			2	0	0	1	1	Delay OFF	0.1 - 30 sec.	BTLF30D	104711	10			
			2	0	0	1	1	Delay OFF	1 - 60 sec.	BTLF60D	104712	10			
			Terminal: ring terminal	2	0	0	1	1	Delay ON	0.1 - 30 sec.	BTRF30C	108903	10		
				2	0	0	1	1	Delay ON	1 - 60 sec.	BTRF60C	108904	10		
	2	0		0	1	1	Delay OFF	0.1 - 30 sec.	BTRF30D	108905	10				
	2	0		0	1	1	Delay OFF	1 - 60 sec.	BTRF60D	108906	10				
	Seaking cover protection for pneumatic timer								BTLFX	113001	5				

Accessories

		Number of contacts	Contacts				For use with:	Cat. no. ⁽¹⁾	Ref. no.	Pack						
	Interlock	Mechanical	•3	•1	•7	•5	CL00 ... CL10	BELA	104723	5						
			•4	•2	•8	•6										
			-	-	-	-										
			Mech./ electrical	2	0	2					-	-	CL00 ... CL10	BELA02	104724	5
			Support interlock	Only for direct current contactors							CL00D...CL10D	SBELA	101017	5		
	Mechanical latch blocks	Frontal mounted to the contactor						CL00 ... CL10	RMLF ♦	see bottom	10					
		♦	D	G	HC	J	N	U	Y							
		50Hz	24, 32	42, 48		110, 115, 120, 127	220, 230, 240	380, 400, 415, 440, 480	500, 660/690							
60Hz	24, 32	48, 60		110, 115, 120, 127	208, 220, 240, 277	380, 400, 415, 440, 480	600									
DC	24, 32, 36	42, 48	60, 72	110, 120, 125	220, 230, 240, 250	440										

1) To complete the catalogue number, replace the symbol ♦ by the code corresponding to the voltage and frequency of the control circuit (see A.52).

For reference numbers, see chapter X, pg. X.4



Order codes

Intro

A

B

C

D

E

F

G

H

I

J/X

Accessories



Transient voltage suppressor block

For use with:	Type	Control circuit	Ue	Cat. no.	Ref. no.	Pack
Fixation to the coil terminals, that allows simultaneous use with the auxiliary contact blocks.						
CL00 ... CL45	R/C	AC	12V ... 48V	BSLR2G	104713	10
CL00 ... CL45	R/C	AC	50V ... 127V	BSLR2K	104714	10
CL00 ... CL45	R/C	AC	130V ... 250V	BSLR2R	104715	10
CL05A ... CL10A	R/C	AC	12V ... 48V	BSLR3G	104716	10
CL05A ... CL10A	R/C	AC	50V ... 127V	BSLR3K	104717	10
CL05A ... CL10A	R/C	AC	130V ... 250V	BSLR3R	104718	10
CL ... D	Diode	DC	12V ... 600V	BSLDZ	104719	10
CL00 ... CL10	Varistor	AC / DC	24V ... 48V	BSLV3G	104720	10
CL00 ... CL10	Varistor	AC / DC	50V ... 127V	BSLV3K	104721	10
CL00 ... CL10	Varistor	AC / DC	130V ... 250V	BSLV3R	104722	10
CL00 ... CL10	Varistor	AC / DC	277V ... 500V	BSLV3U	110836	10



Electronic timer module

For use with:	Control circ.	Type	Time	Cat. no.	Ref. no.	Pack
Fixation to the coil terminals, that allows simultaneous use with the auxiliary contact blocks.						
CL00 ... CL10	24-250V AC/DC	delay ON	0.1 - 2 sec.	BETL02C	113602	5
CL00 ... CL10	24-250V AC/DC	delay ON	1.5 - 45 sec.	BETL45C	113603	5
CL00 ... CL10	24-250V AC/DC	delay OFF	0.1 - 2 sec.	BETL02D	113604	5
CL00 ... CL10	24-250V AC/DC	delay OFF	1.5 - 45 sec.	BETL45D	113605	5

Accessories

Identification

For use with:		Cat. no.	Ref. no.	Pack
CL00 ... CL10	Sheets of labels (sheets of 260 labels each)	EAT 260	100548	1
CL00 ... CL10	Labelling plate base (50 pieces in one pack)	SPR	100549	1

Pole terminal protector IPXXB

For use with:		Cat. no.	Ref. no.	Pack
CL03 ... CL04		PTP04	113850	8
CL45		PTP45	113851	6
CL05 ... CL08		PTP08	113852	8
CL09 ... CL10		PTP10	113853	8

Spares

Contact kits

For use with:	Number of sets	Type	Cat. no.	Ref. no.	Pack
CL03_3 / CL03_4	3	NO	V31203B	104743	1
CL03_B	4	2NAO-2NC	VB1203B	133170	1
CL04_3 / CL04_4	3	NO	V31204B	104745	1
CL04_B	4	2NO-2NC	VB1204B	133885	1
CL45_3	3	NO	V31245B	104758	1
CL05_4	4	NO	V31205B	104747	1
CL05_B	4	2NO-2NC	VB1205B	104748	1
CL06	3	NO	V31206B	104749	1
CL07_3 / CL07_4	3	NO	V31207B	104750	1
CL07_B	4	2NO-2NC	VB1207B	104751	1
CL08_3 / CL08_4	3	NO	V31208B	104752	1
CL08_B	4	2NO-2NC	VB1208B	104753	1
CL09	3	NO	V31209B	104754	1
CL10	3	NO	V31210B	104755	1



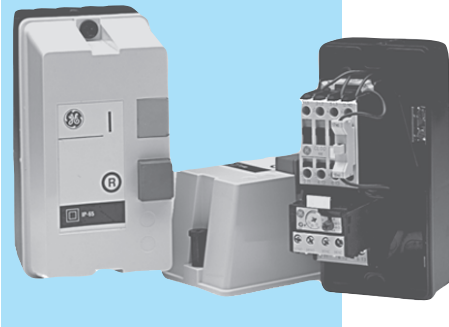

Direct-on-line starters

Series CL
9 to 105A (AC-3)



- Power circuit: up to 690V AC
- Control circuit: up to 690V AC
- Protection degree IP00

Series CL - Direct-on-line starters

	For use with	Push-buttons	Protection degree	Cat. no.	Ref. no	Pack
 <p>Empty boxes</p>	CL00, CL01, CL02	Start/Stop + Reset	IP40	LG0004P1B0	209344	1
			IP65	LG0006P1B0	200004	1
		Without push-buttons	IP40	LG0004S1B0	209347	1
			IP65	LG0006S1B0	116011	1
		Only Reset	IP40	LG0004R1B0	116651	1
			IP65	LG0006R1B0	116652	1
	CL25	Start/Stop + Reset	IP40	LG2504P1B0	100885	1
			IP65	LG2506P1B0	101095	1
		Only Reset	IP40	LG2504R1B0	116226	1
	CL04	Start/Stop + Reset	IP65	LG2506R1B0	133611	1
			IP40	LG0404P1B0	116653	1
		Only Reset	IP65	LG0406P1B0	116656	1
CL25, CL04	Without push-buttons	IP40	LG0404R1B0	133264	1	
		IP65	LG0406R1B0	133265	1	
		IP40	LG0404S1B0	116996	1	
			IP65	LG0406S1B0	116997	1
 <p>Neutral terminal</p>				BNL	104797	10
 <p>Conversion to permanent control</p>	Pressure-fixed between push-buttons in direct-on-line enclosures for mechanical interlocking into permanent control.			EPL	104798	10
 <p>Start contact block</p>	Pressure-fixed onto the front of direct-on-line starters allowing electrical operation using the start push-button on the enclosure			BMLF	104800	10

Order codes

Intro

A

B

C

D

E

F

G

H

I

J/X

Wiring diagrams ● page A.132
Dimensions ● page A.137



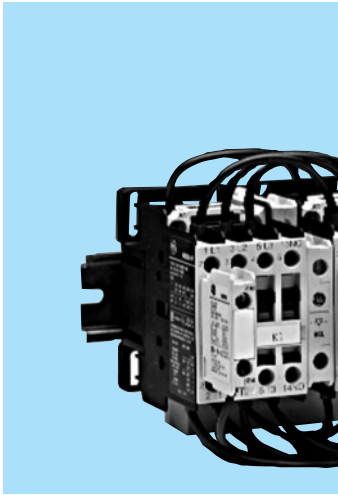

Reversing starters

9 to 40A (AC-3)

- Power circuit: up to 690V AC
- Control circuit: up to 690V AC
- IP00 version
- Polycarbonate enclosure (IP40 - IP65)
 - Shock resistance
 - Total insulation \square
 - 4 knock-out input holes
- Empty enclosures version
- Start contact block

Series CL - Reversing starters

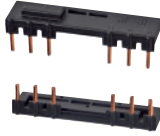
	Description	For use with contactor	ac/dc	Cat. no.	Ref. no.	Pack.
 <p>Wiring kits for reversing starters</p>	Suitable to be used with link modules Upper and lower connections without overload relays	CL00,, CL01,, CL02..	ac/dc	WKLI02P	101422	1
		Plate	CL06, CL07, CL08 CL08, CL09, CL10		WKI0910 WKI0608	241751 241752

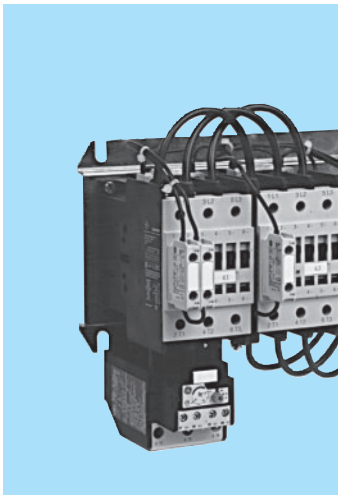

Star-delta starters

Series CL

- Power circuit: up to 690V AC
- Control circuit: up to 690V AC
- Protection degree IP00
- Use delay setting by electronic relay NMET
- Terminals protected against accidental contact

Series CL - Star-delta starters

	Description	Line-delta contactor	Cat. no.	Ref. no.	Pack
<p>Busbar sets for power circuit</p>		CL00	WKLE00	103238	1
		CL01, CL02	WKLE02	103241	1
<p>Plate</p>	Metallic plate	CL06, CL07, CL08 CL09, CL10	WLSD WLSD1	103247 241750	1 1

Order codes ● page A.60
 Wiring diagrams ● page A.132
 Dimensions ● page A.137



Notes

Grid area for notes.

Order codes

Intro

A

B

C

D

E

F

G

H

I

J/X



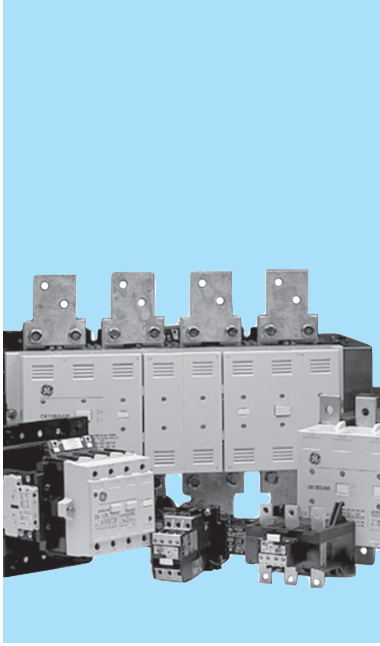

Three and four pole contactors 150 to 825A (AC3) 200 to 1250A (AC1)

- Control circuit: Alternating current up to 690V
Direct current up to 500V
- Degree of protection IP00 (IPxxB with accessories)
- CK07...CK13: auxiliary and coil terminals originally protected against accidental contacts.
Protection for power contacts on request (see accessories)
- Terminals protected against accidental contacts according to VDE 0106 T.100, VBG4.
- CK_ _E with electronic module suitable for DC and AC. (50/60Hz)
- CK contactors always provided with one auxiliary contact block BCLL11 (1NO+1NC)

Standards

IEC/EN 60947-1	CSA 22.2/14
IEC/EN 60947-4-1	CENELEC HD 419
IEC/EN 60947-5-1	NFC 63-110
EN 50005	ASE 1025
UL 508	UNE 20109
NEMA ICS 1	VDE 0660/102
BS 5424 & 775	

Approvals/Marking

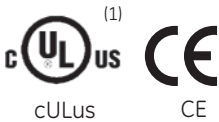

(Contact GE for details)

Standard voltages

To complete the catalogue number, replace the symbol \blacklozenge by the code corresponding to the voltage and frequency of the control circuit.

Alternating current (V)

Three-pole contactors: CK75CA3..., CK08CA3..., CK85BA3...
Four-pole contactors: CK07BA4..., CK08BA4...

\blacklozenge	C	D	F	G	H	I	J	K	M	N	R	S	T	U	V	W	X	Y	Z
50Hz	24	42	48				110	127		220	240			380		415	440	500	660
60Hz	24		48		110	120			220	277		240	380	480	440				600

Alternating current (V). Dual-frequency coil

Three-pole contactors: CK75CA3..., CK08CA3..., CK85BA3...
Four-pole contactors: CK07BA4..., CK08BA4...

\blacklozenge	1	2	3	6	13
50/60Hz	24	48	110	230	400

Alternating current (V)

Three-pole contactors: CK13BA3...
Four-pole contactors: CK13BA4...

\blacklozenge	J	N	U	Y	Z
50/60Hz	110	220	380	480	600
	240	440	500	660	

Control circuit with rectifier bridge

\blacklozenge	J	N	U
50Hz	110	220	380
	230	400	
60Hz	120	240	480

Direct current (V). With electronic module (0.7 ... 1.3 x Us)

Three-pole contactors: CK75CE3..., CK08CE3....

\blacklozenge	WD	WE	WF	WH	WJ	WN
Voltage	24	33	48	72	110	220

Alternating c. / Direct c. (V). With electronic module (0.8 ... 1.10 x Us)

Three-pole & four-pole contactors: CK E.....

\blacklozenge	D	F	J	N	U	Y
Voltage	24	42	110	220	380	440
	28	48	127	250	415	500

(1) CK13 not UL

- Order codes pg. A.63
- Aux. contact blocks pg. A.64
- Accessories & Spares pg. A.65
- Technical data pg. A.102
- Dimensions pg. A.118



Three pole contactors



Max.oper.current		Admissible power AC3					Electrical endurance	Control circuit: Alternating current		Control circuit: A.C. / D.C.	
Non-inductive loads	Motors <440V, 3 ~ 50/60Hz	220V 230V	380V 400V	415V 440V	440V 440V	500V		Cat. AC3 Operations	Cat. no. (1)	Pack	Cat. no. (1)
AC1 A	AC3 A	kW HP	kW HP	kW HP	kW HP	kW HP		Ref. no. see bottom		Ref. no. see bottom	
250	150	45 60	75 100	80 108	80 108	100 135	1.7x10 ⁶	CK75CA311 ♦	1	CK75CE311 ♦	1
250	185	55 75	90 125	100 135	100 135	110 150	1.2x10 ⁶	CK08CA311 ♦	1	CK08CE311 ♦	1
315	205	65 88	110 150	125 170	125 170	132 180	1.7x10 ⁶	CK85BA311 ♦	1	CK85BE311 ♦	1
315	250	75 100	132 180	132 180	132 180	160 220	1.5x10 ⁶	-		CK09BE311 ♦	1
450	309	90 125	160 220	160 220	185 250	200 270	1.1x10 ⁶	-		CK95BE311 ♦	1
600	420	125 170	220 300	230 312	230 312	300 405	1x10 ⁶	-		CK10CE311 ♦	1
700	550	160 220	280 380	315 425	315 425	400 540	0.8x10 ⁶	-		CK11CE311 ♦	1
1000	700	220 300	375 510	400 540	425 580	480 650	0.7x10 ⁶	-		CK12BE311 ♦	1
1250	825	250 340	450 610	450 610	450 610	500 680	0.7x10 ⁶ (2)	CK13BA311 ♦	1	-	

Spare coil	CK75CA3 ... CK08CA3	C12168 ♦	1	-
	CK85BA3	C04255 ♦	1	-
	CK13BA3	C08998 ♦	1	-
	Control circuit with incorporated rectifier bridge CK13BA3	C09120 ♦	1	-
Coil	CK75CE3 ... CK08CE3	-		KB4E ♦ 1
	CK85BE3 ... CK95BE3	-		KB5E ♦ 1
	CK12BE3	-		KB6E ♦ 1
Electronic module	CK10CE3 ... CK11CE3	-		KB7E ♦ 1
	CK75CE3 ... CK08CE3	-		KM4E ♦ 1
	CK85BE3 ... CK95BE3	-		KM5E ♦ 1
	CK12BE3	-		KM6E ♦ 1
	CK10CE3 ... CK11CE3	-		KM7E ♦ 1

(1) To complete the catalogue number, replace the symbol ♦ by the code corresponding to the voltage and frequency of the control circuit (see A.62).
 (2) CK13 non allow the aux. block in right side.

Order codes

Intro

A

B

C

D

E

F

G

H

I

J/X

For reference numbers, see chapter X, pg. X.5



Four pole contactors

Max.oper. current	Admissible power							Electrical endurance	Control circuit: Alternating current		Control circuit: A.C. / D.C.		
	AC3		AC1						Cat. AC3	Cat. no. ⁽¹⁾	Pack	Cat. no. ⁽¹⁾	Pack
	380V 400V		220V 230V	380V 400V	415V	440V	500V						
Non-inductive loads AC1 A	kW	A	kW	kW	kW	kW	kW	Operations	Ref. no. see bottom		Ref. no. see bottom		
200	55	105	76	131	143	151	173	1x10 ⁶	CK07BA41 ♦ CK07BA411	1	CK07BE411 ♦	1	
325	100	185	123	214	233	247	281	0.6x10 ⁶	CK08BA411 ♦	1	CK08BE411 ♦	1	
400	132	250	152	263	287	304	346	0.6x10 ⁶	-		CK09BE411 ♦	1	
500	160	309	191	329	359	380	415	0.6x10 ⁶	-		CK95BE411 ♦	1	
600	220	408	228	395	431	456	519	0.5x10 ⁶	-		CK10CE411 ♦	1	
700	280	530	266	460	503	533	606	0.4x10 ⁶	-		CK11CE411 ♦	1	
1000	375	680	381	658	719	762	866	0.4x10 ⁶	-		CK12BE411 ♦	1	
1250	450	800	476	822	898	952	1082	0.6x10 ⁶ (2)	CK13BA411 ♦	1			



Spare coil

	CK07BA4	C04255 ♦	1	-
	CK08BA4	C04787 ♦	1	-
	CK13BA4	C08998 ♦	1	-
	Control circuit with incorporated rectifier bridge CK13BA4	C09120 ♦	1	-
Coil	CK07BE4	-		KB5E ♦ 1
	CK08BE4 ... CK95BE4, CK12BE4	-		KB6E ♦ 1
	CK10CE4 ... CK11CE4	-		KB7E ♦ 1
Electronic module	CK07BE4	-		KM5E ♦ 1
	CK08BE4 ... CK95BE4, CK12BE4	-		KM6E ♦ 1
	CK10CE4 ... CK11CE4	-		KM7E ♦ 1

(1) To complete the catalogue number, replace the symbol ♦ by the code corresponding to the voltage and frequency of the control circuit (see A.62).
 (2) CK13 non allow the aux. block in right side.

Auxiliary instantaneous contact block

Number of contacts	Contacts				Cat. no.	Ref. no.	Pack
	•3 •4	•1 •2	•7 •8	•5 •6			
2	2	0	0	0	BCLL20	104706	10
2	1	1	0	0	BCLL11	104707	10
2	1	1	0	0	BCLL11-K ⁽¹⁾	248083	10
combinations of more than 2 blocks							
2	2	0	0	0	BRLl20	104704	10
2	1	1	0	0	BRLl11	104705	10
2	0	2	0	0	BRLl02	106622	10





Side mounting

(1) For high shock/vibrations environments

For reference numbers, see chapter X, pg. X.5



Accessories

	For use with:	Mounting	Voltage	Ue	Cat. no.	Ref. no.	Pack
 <p>Transient voltage suppressor</p>	Fixation to the coil terminals, that allows simultaneous use with the auxiliary contact blocks.						
	CK75 ... CK08		AC	24V - 48V	BSLR3G	104716	10
	CK75 ... CK08		AC	50V - 127V	BSLR3K	104717	10
	CK75 ... CK08		AC	130V - 240V	BSLR3R	104718	10
	CK75 ... CK08		AC	227V - 500V	BSLV3U	110836	10
	CK85 ... CK13		AC	24V	KRC24	104760	10
	CK85 ... CK13		AC	260V	KRC48/260	104761	10
	CK85 ... CK13		AC	415V	KRC380/415	104762	10
 <p>Mechanical interlock</p>	CK07B ... CK12	Horizontal			BEKH	104763	1
	CK07B ... CK95	Vertical			BEKVS 1	104786	1
	CK10C ... CK12B	Vertical			BEKVA 1	104785	1
	CK13	Vertical			BEKV	104764	1
<p>Pole terminal protection</p>	CK75C ... CK08C	1 pole. VDE0106			CM1CA5F	105200	1
	CK85B ... CK12B	1 pole. VDE0106	Contactors 3P		C09476	104766	6
	CK08B ... CK12B	1 pole. VDE0106	Contactors 4P		C09479	204800	8
	CK75C ... CK08C	1 pole IPXXB			PTPCK75	103747	1 ⁽¹⁾
	CK85B ... CK95B	1 pole IPXXB			PTPCK95	103748	3 ⁽²⁾
	CK10C ... CK12B	1 pole IPXXB			PTPCK11	103749	1 ⁽¹⁾

(1) One phase
(2) Three pole

Spares

	For use with:	Type		Cat. no.	Ref. no.	Pack
 <p>Contact kits</p>	One set consists of two fixed contacts, one moving contact and accessory parts. When contact replacement is needed, it is recommended to replace all the contacts at the same time.					
	CK07B	NA		V1107BA	113612	1
	CK75C	NA		V1175CA	113613	1
	CK08C	NA		V1108CA	113614	1
	CK08B	NA	Contactors 4P	V1108BA	113505	1
	CK85B	NA		V1185BA	113615	1
	CK09B	NA		V1109BA	113616	1
	CK09B	NA	Contactors 4P	V1109BA	113899	1
	CK95B	NA		V1195BA	113617	1
	CK10C	NA		V1110CE	113618	1
	CK11C	NA		V1111CE	113619	1
	CK12B	NA		V1112BA	113620	1
	CK13B	NA		V1113BA	113621	1

Order codes

Intro

A

B

C

D

E

F

G

H

I

J/X



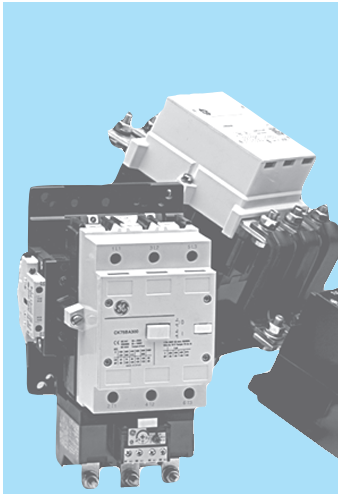

Direct-on-line starters

150 to 825A (AC-3)

- Power circuit: up to 1000V AC
- Control circuit: up to 690V AC
- Protection degree IP00
- Terminals protected against accidental contact: IP20
 - KG75 to KG12: Coil and auxiliary terminals with built-in protection
Main terminals protector on request
 - KG13: Coil and auxiliary terminals with built-in protection

Series CK - Direct-on-line starters. IP00

			Cat. no.	Ref. no.	Pack
Connection sets	Busbar set for power circuit	CK85,CK09,CK95	KVP85G	104770	1
		CK10,CK11	KVP10G	104771	1
		CK12	KVP12G	104767	1
Plate	Metallic plate	CK85, CK09, CK95	PVP85G	241747	1
		CK10, CK11	PVP10G	241748	1
		CK12	PCP12G	241749	1

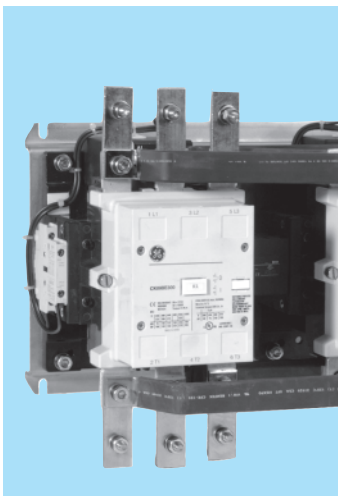

Reversing starters

150 to 825A (AC-3)

- Power circuit: up to 1000V AC
- Control circuit: up to 690V AC
- Protection degree IP00

Series CK - Reversing starters. IP00

	Description	For use with contactor		Cat. no.	Ref. no.	Pack.
Connection sets	Busbar set for power circuit	CK75, CK08		KVP75U	113627	1
		CK85, CK09, CK95		KVP85U	113628	1
		CK10, CK11		KVP10U	133374	1
		CK12		KVP12U	113630	1
	Busbar set for power circuit For assembly with thermal overload relay.	CK75, CK08		KVP75I	133370	1
		CK85, CK09, CK95		KVP85I	113631	1
		CK10, CK11		KVP10I	133371	1
		CK12		KVP12I	113633	1
Plate	Metallic plate	CK75, CK08		KVB75I	104690	1
		CK85, CK95		KVB95I	104691	1
		CK10, CK11		KVB10I	104692	1
		CK12		KVB12I	104693	1

Order codes ● page A.66-67
 Wiring diagrams ● page A.135
 Dimensions ● page A.138

Star-delta starters

Series CK

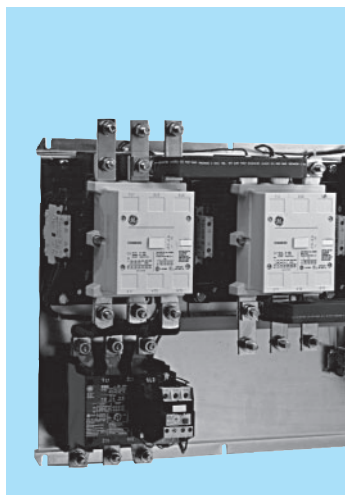

- Power circuit: up to 1000V AC
- Control circuit: up to 690V AC
- Protection degree IP00
- Protection against accidental contacts: IP20
 - KE75: Built-in protection
 - KE08 - KE12: Coil and auxiliary terminals with built-in protection
Main terminals protector on request
 - KE13: Coil and auxiliary terminals with built-in protection

Series CK - Star-delta starters. IP00

		Line-delta contactor	Star contactor	Cat. no.	Ref. no.	Pack
Busbar sets for power circuit		CK75, CK08	CK75, CK08	KVP75E	133378	1
		CK85, CK09, CK95	CK75, CK08	KVP08E	116212	1
		CK95	CK85, CK09, CK95	KVP85E	133379	1
		CK10, CK11	CK85, CK09, CK95	KVP95E	113637	1
		CK10, CK11	CK10, CK11	KVP10E	133380	1
		CK12	CK10, CK11	KVP12E	116235	1
Plate	Metallic plate	CK75, CK08		KVB75E	104694	1
		CK85, CK95		KVB95E	104695	1
		CK10, CK11		KVB10E	104597	1
		CK12		KVB12E	104587	1

Order codes

Intro

A

B

C

D

E

F

G

H

I

J/X



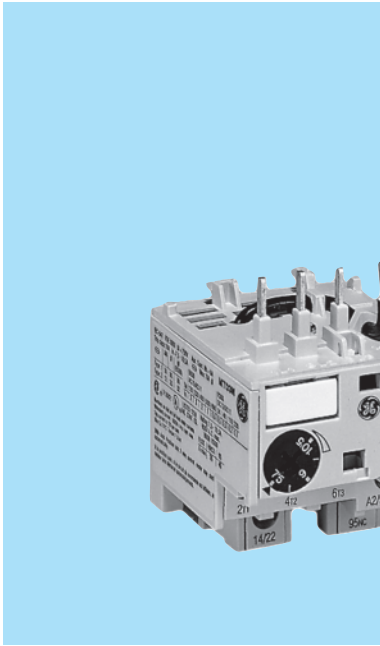

Thermal overload relays for contactors from 0.11 to 14A

- Control circuit up to 690V
- Power circuit up to 690V
- Three-pole differential (phase unbalance protection)
- Automatic ambient temperature compensation between -25°C and +60°C
- Choice of manual or automatic reset
- Direct connection to contactor or independent mounting using accessories.
- Screw and Ring terminal versions
- Terminals protected against accidental contact in accordance with VDE 0106 T.100 and VBG4.
- Terminal numbering in accordance with EN 50005
- Degree of protection IP20 (EN 60529)
- Additional auxiliary contact block 1NO (with manual reset only)

Standards

IEC/EN 60947-4-1	CSA 22.2/14
IEC/EN 60947-5-1	NI C 63-650
UNE 115	VDE 0660
NFC 63-650	UL 508

Approvals/Marking



General characteristics

- Thermal protection against balanced overload.
- Three-pole differential (phase unbalance protection).
- Automatic ambient temperature compensation.
- Front mounted selector for choosing utilisation current.
- Reset button, 2 positions :
Manual(H) and Automatic(A) by turning the blue selector.
- Stop push button, independent of reset (red).
- Manual trip lever (tripping test).
- Tripping indicator (0-1).
- To facilitate wiring arrangements terminal 96 fits directly onto coil terminal (A2) and terminal 14/22 fits directly onto the feedback auxiliary contact.

Order codes ● pg. A.69
 Technical data ● pg. A.120
 Dimensions ● pg. A.121



Thermal overload relays for contactors

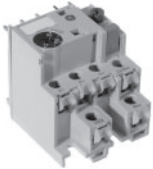

For use with:	Setting range (regulation)		Fuse				Terminal: screw		Terminal: ring terminal		Pack
			aM		gL		Cat. no.	Ref. no.	Cat. no.	Ref. no.	
			Type 2	Type 1	Type 2	Type 1					
	min. A	max. A	A	A	A	A					
MC0...	0.11	0.17	0.5	0.5	0.5	0.5	MT03A	101000	MT03RA	103540	10
MC1...	0.17	0.26	0.85	1	1	1	MT03B	101001	MT03RB	103541	10
MC2...	0.26	0.43	1	2	2	4	MT03C	101002	MT03RC	103542	10
	0.43	0.65	1	4	2	8	MT03D	101003	MT03RD	103543	10
	0.65	1	2	6	4	12	MT03E	101004	MT03RE	103544	10
	0.85	1.3	2	6	4	12	MT03F	101005	MT03RF	103545	10
	1.1	1.6	2	10	4	16	MT03G	101006	MT03RG	103546	10
	1.35	2	4	10	6	16	MT03H	101007	MT03RH	103547	10
	1.7	2.4	4	16	6	25	MT03I	101008	MT03RI	103548	10
	2.2	3.2	4	20	6	32	MT03J	101009	MT03RJ	103549	10
	2.5	4	4	20	6	32	MT03R	101015			10
	3	4.7	6	20	10	32	MT03K	101010	MT03RK	103550	10
	4	6.3	10	32	16	50	MT03L	101011	MT03RL	103551	10
	5.5	8	12	50	20	63	MT03M	101012	MT03RM	103552	10
	7.5	10.5	16	50	25	80	MT03N	101013	MT03RN	103553	10
	10	14	20	32	32	100	MT03P	101014	MT03RP	103554	10

Accessories



Input terminals

Terminal	Cat. no.	Ref. no.	Pack
Screw	MVE0T	101020	5
Ring terminal	MVE0R	103562	5



Base

For separate mounting onto standard EN 50022-35 profile	MVB0T	101021	5
---	-------	--------	---



Auxiliary contact block

Frontal fixing to the relay With trip indicator (0-I) One block per relay and only for manual reset	Screw	MATV10AT	101022	10
	Ring terminal	MATV10AR	103563	10

Identification

Sheets of labels (sheets of 260 labels each) Labeling plate base (50 pieces in one pack)	EAT 260	100548	1
	SPR	100549	1

Order codes

Intro

A

B

C

D

E

F

G

H

I

J/X



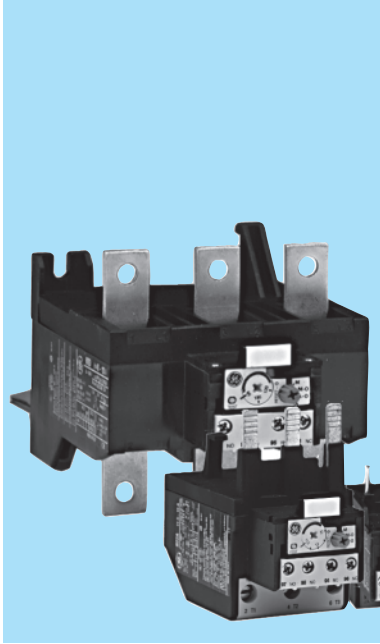

Thermal overload relays for contactors from 0.16 to 850A

- Control circuit up to 690V AC
- Power circuit:
 - RT1, RT12: up to 690V
 - RT2, RT22, RT3, RT32, RT4/4L, RT5/5L & RT6/6L: up to 1000V
- Thermal protection against normal overloads.
- Three pole differential (phase unbalance protection).
- Protection against long starting times.
- Automatic ambient temperature compensation between - 25°C + 60°C.
- Front mounted test button.
- Trip indication.
- Independent auxiliary contacts with double rupture (1NO + 1NC).
- Function selector:
 - Manual RESET
 - Manual RESET and STOP
 - Automatic RESET with STOP
 - Automatic RESET without STOP

Standards

IEC/EN 60947-4-1	CSA 22.2/14
IEC/EN 60947-5-1	NI C 63-650
UNE 115	VDE 0660
NFC 63-650	UL 508
CEI 17-50	

Approvals/Marking



Lloyd's Register



Bureau Veritas



RINA



(Contact GE for details)

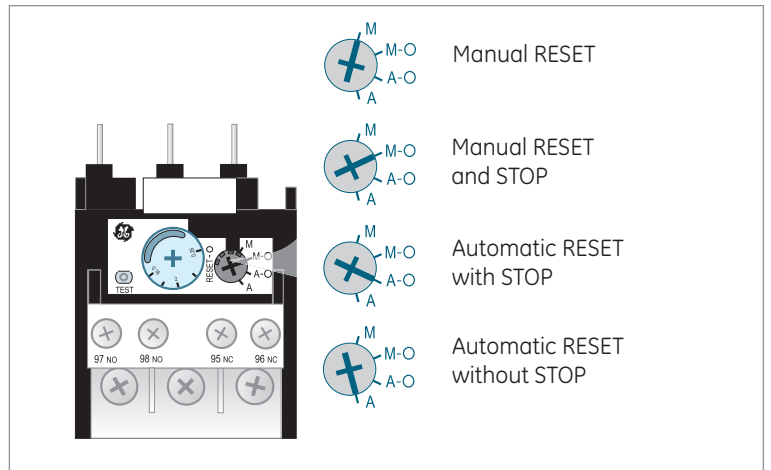

Order codes ● pg. A.71
 Technical data ● pg. A.122
 Dimensions ● pg. A.123



Thermal overload relays for contactors



	For use with:	Setting range (regulation)		Fuses ⁽¹⁾		Srew terminal		Ring terminal		Pack	
				aM	gL - gG						
				min. A	max. A	A	A	Cat. no.	Ref. no.		Cat. no.
Class 10A	CL00	0.16	0.26	2	2	RT1B	113700	RT1RB	114087	5	
	CL01	0.25	0.41	2	2	RT1C	113701	RT1RC	114088	5	
	CL02	0.4	0.65	2	2	RT1D	113702	RT1RD	114089	5	
	CL25	0.65	1.1	2	4	RT1F	113703	RT1RF	114090	5	
	CL03	1.0	1.5	4	6	RT1G	113704	RT1RG	114091	5	
	CL04	1.3	1.9	4	6	RT1H	113705	RT1RH	114092	5	
	CL45	1.8	2.7	6	10	RT1J	113706	RT1RJ	114093	5	
		2.5	4.0	8	16	RT1K	113707	RT1RK	114094	5	
		4.0	6.3	12	20	RT1L	113708	RT1RL	114095	5	
		5.5	8.5	16	20	RT1M	113709	RT1RM	114096	5	
		8.0	12.0	20	25	RT1N	113710	RT1RN	114097	5	
		10.0	16.0	25	35	RT1P	113711	RT1RP	114098	5	
		14.5	18.0	32	50	RT1S	113712	RT1RS	114099	5	
		17.5	22.0	40	50	RT1T	113713	RT1RT	114100	5	
		21.0	26.0	40	63	RT1U	113714	RT1RU	114101	5	
		25.0	32.0	50	80	RT1V	113715	RT1RV	114102	5	
		30.0	40.0	63	100	RT1W	113716	RT1RW	114103	5	
Class 10	CL05	11.5	15.0	32	35	RT2A	113717	RT2RA	114104	1	
	CL06	14.5	19.0	40	50	RT2B	113718	RT2RB	114132	1	
	CL07	18.5	25.0	50	63	RT2C	113719	RT2RC	114106	1	
	CL08	24.0	32.0	63	100	RT2D	113720	RT2RD	114133	1	
	CL09	30.0	43.0	80	125	RT2E	113721	RT2RE	114134	1	
	CL10	42.0	55.0	100	160	RT2G	113722	RT2RG	114109	1	
		54.0	65.0	125	160	RT2H	113723	RT2RH	114146	1	
		64.0	82.0	125	200	RT2J	113724	RT2RJ	114136	1	
		78.0	97.0	125	200	RT2L	113725	RT2RL	114235	1	
		90.0	110	160	250	RT2M	113726	RT2RM	114113	1	
Class 20	CL00	0.4	0.65	2	2	RT12D	139138	RT12RD	114060	5	
	CL01	0.65	1.1	2	4	RT12F	139139	RT12RF	114061	5	
	CL02	1	1.5	4	6	RT12G	139140	RT12RG	114062	5	
	CL25	1.3	1.9	4	6	RT12H	139141	RT12RH	114063	5	
	CL03	1.8	2.7	8	10	RT12J	139142	RT12RJ	114159	5	
	CL04	2.5	4.1	8	16	RT12K	113640	RT12RK	114114	5	
	CL45	4	6.3	12	20	RT12L	113641	RT12RL	114115	5	
		5.5	8.5	16	20	RT12M	113642	RT12RM	114116	5	
		8	12	20	35	RT12N	113643	RT12RN	114117	5	
		10	16	25	35	RT12P	113644	RT12RP	114118	5	
		14.5	18	32	50	RT12S	113645	RT12RS	114119	5	
		17.5	22	40	50	RT12T	113646	RT12RT	114120	5	
		21	26	40	63	RT12U	113647	RT12RU	114121	5	
		25	32	50	80	RT12V	113648	RT12RV	114122	5	
		30	40	63	100	RT12W	113649	RT12RW	114123	5	
		CL05	24	32	63	80	RT22D	113650	RT22RD	114124	1
		CL06	30	43	80	100	RT22E	113651	RT22RE	114141	1
		CL07	42	55	100	160	RT22G	113652	RT22RG	114126	1
		CL08	54	65	125	160	RT22H	113653	RT22RH	114127	1
		CL09	64	82	125	200	RT22J	113654	RT22RJ	114128	1
		CL10	78	97	125	200	RT22L	113655	RT22RL	114143	1
			90	110	160	250	RT22M	113656	RT22RM	114130	1

(1) Most suitable fuse in accordance with IEC 60947-4-1.

(continued on page A.72)

Order codes

Intro

A

B

C

D

E

F

G

H

I

J/X

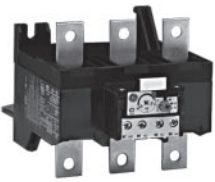

Thermal overload relays for contactors (continued)

	For use with:	Setting range (regulation)		Fuses ⁽¹⁾		Cat. no. (Screw terminal)	Ref. no.	Pack	
		min.	max.	aM	gL - gG				
		A	A	A	A				
	Class 10 CK75 CK08 Direct mounting	55	80	125	200	RT3B	113727	1	
		63	90	125	200	RT3C	113728	1	
		90	120	160	250	RT3D	113729	1	
		110	140	200	315	RT3E	113730	1	
		140	190	250	355	RT3F	113731	1	
		CK85	120	190	250	315	RT4N	113732	1
	CK09	175	280	315	400	RT4P	113733	1	
		200	310	400	500	RT4R	113734	1	
	CK12 ⁽³⁾	120	190	250	315	RT5A	113750	1	
		175	280	315	400	RT5B	113751	1	
		250	400	500	630	RT5C	113752	1	
		315	500	630	800	RT5D	113753	1	
		430	700	800	1000	RT5E	113754	1	
	CK13 ⁽⁴⁾	500	850	100	1250	RT6A	113760	1	
Class 20	CK75 CK08 Direct mounting	63	90	125	200	RT32C	113657	1	
		90	120	160	250	RT32D	113658	1	
		110	140	200	315	RT32E	113659	1	
		140	190	250	355	RT32F	113660	1	
Class 30	CL... CK... Mounting with screws	2.5	4	10	16	RT4LA	113735	1	
		4	6.5	12	20	RT4LB	113736	1	
		5.5	8.5	16	25	RT4LC	113737	1	
		7.5	11	20	32	RT4LD	113738	1	
		10	16	25	40	RT4LE	113739	1	
		12.5	20	32	50	RT4LF	113740	1	
		17	27	50	80	RT4LG	113741	1	
		26	40	80	125	RT4LH	113742	1	
		32	52	100	160	RT4LJ	113743	1	
		45	70	125	160	RT4LK	113744	1	
	CK85 CK09 CK95 ⁽²⁾	60	90	160	200	RT4LL	113745	1	
		80	125	200	250	RT4LM	113746	1	
		120	190	250	315	RT4LN	113747	1	
		175	280	315	400	RT4LP	113748	1	
		200	310	400	500	RT4LR	113749	1	
		CK10 CK11 CK12 ⁽³⁾	120	190	250	315	RT5LA	113755	1
			175	280	315	400	RT5LB	113756	1
			250	400	500	630	RT5LC	113757	1
			315	500	630	800	RT5LD	113758	1
			430	700	800	1000	RT5LE	113759	1
CK13 ⁽⁴⁾	500	850	1000	1250	RT6LA	113761	1		



(1) Most suitable fuse in accordance with IEC 60947-4-1.

(2) Fitting direct to the contactor.

(3) Fitting direct to the contactor: by means of a coupling and connection set. Separate mounting with screws on DIN rail / with cable connection.

(4) RT6A = RT1 with right setting range plus RTXP, independent mounting base adaptor, to be utilised with current transformer connected by passing cable chosen by customer. Current transformer data on request.

Accessories

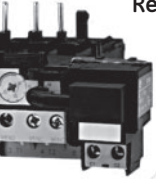
			Cat. no.	Ref. no.	Pack
 <p>Base for separate mounting</p>	DIN EN50022-35				
	RT1		RTXP	105170	1
	RT2		RT2XP	113764	1
<p>Setting range cover protection</p>	RT...		RTX3	113762	1
 <p>Push-button with flexible cable</p>	for distance RESET				
	RT1... - RT6... (front)	0.5 meters	RTXS	113855	1
	RT1... - RT6... (front)	1 meters	RTXSL	113856	1
	RT1..., RT2..., RT4..., RT5..., RT6... (back)		RTXBS	108864	1
<p>Terminal protection</p>	for RT3 or CK75C/CK08C				
	Thermal overload relay	1 pole IPxxB	PTPCK75	103747	1
	Connection contactor-relay	3 poles	RT3PXX3P	110565	1
 <p>Remote electrical reset</p>	RT1... - RT6...		RTXRR ♦		1

Available coil voltages (V)

	♦	B	D	G	J	N	U	X
AC/DC		12	24	48	110	220	380	440
					240	415	480	



Electronic overload relays

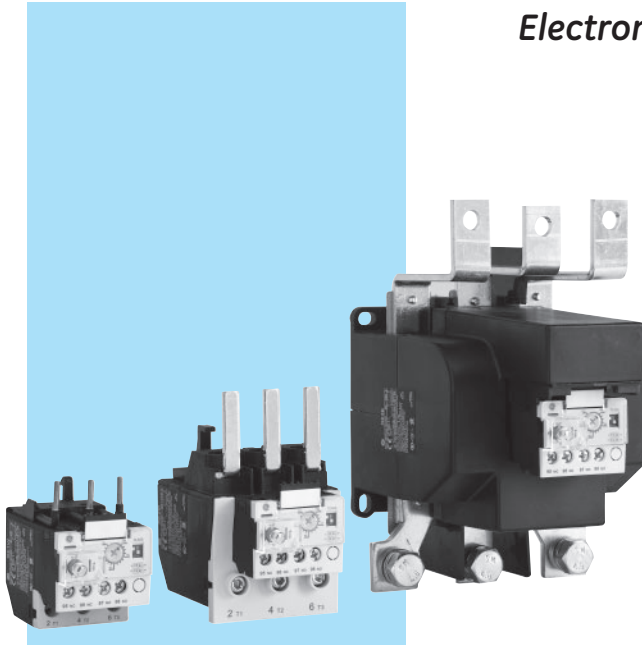

Approvals/Marking



Product features

➤ Your benefits

- | | |
|---|---|
| Lower power consumption | ➤ Saving space into cabinet |
| Great accuracy | ➤ Better motor protection |
| Full reliability | ➤ Low risk to burn motor |
| Phase unbalance protection | ➤ Better motor protection and current control |
| Direct fitting to contactors Series CL | ➤ Compact starter |
| Interchangeable with thermal overload relay | ➤ No need to redesign existing cabinet |
| Multiple trip class selection | ➤ One device cover for start time motor |
| Manual / Auto reset | ➤ One device for two solutions |

Main characteristics

- Setting range from 0.1 up to 150A
- Self powered
- Thermal memory
- Phase loss protection
- Phase unbalance protection
- Direct fitting to contactors Series CL
- Interchangeable with thermal overload relay
- Multiple trip class selection
- Manual / Auto reset
- Increased flexibility, less order codes, less stock
- Tripp class: 5 - 10 - 20 - 30

Order codes ● pg. A.75
 Technical data ● pg. A.128
 Dimensions ● pg. A.130



Intro

A

B

C

D

E

F



G

H

I

J/X

Electronic overload relays for contactors

	Suitable for	Setting range (A)		Fuses (A) ⁽¹⁾	Cat. no.	Ref. no.	Pack.
		Min.	Max.	gL - gG			
 Frame 1	CL00...CL45	0,1	0,5	2	RE1D	101866	5
		0,4	2	4	RE1H	101867	5
		1,0	5	10	RE1K	101868	5
		1,6	8	20	RE1M	101869	5
		6,4	32	63	RE1S	101870	5
		9,0	45	80	RE1W	101871	5
 Frame 2	CL05...CL10	15	75	125	RE2H	101872	1
		22	110	125	RE2M	101873	1
 Frame 3	CK75-CK08	30	150	250	RE3E	101874	1

Accessories

		Cat. no.	Ref. no.	Pack.
Transparent cover for pushbutton reset	For frames 1, 2 and 3	RETC	247795	10
 pendent mounting base adaptor	Frame 1	RE1XP	247302	1
	Frame 2	RE2XP	247303	1

(1) Most suitable fuse in accordance with IEC 60947-4-1, see coordination table on pg. A.128.

Order codes

Intro

A

B

C

D

E

F

G

H

I

J/X





Intelligent motor management relay EntelliPro ES3 / ES5

- Motor protection and motor control
- Pre-programmed motor typicals
- Communication Interface to Profibus-DP and Modbus RTU system
- Status information from motor and switchgear
- Maintenance information,
- Management of settings and configuration
- Predefined control logic
- Internal event recording with time stamping
- Local control and display devices

Protection

- Overload (Class 5 to 40)
- Earth fault (Residual current)
- Phase loss
- Thermistor (PTC)
- Start current
- Blocked rotor
- Under load
- Maximum starts per time
- Self monitoring
- External device monitoring

Diagnostic

- Time to overload trip, release
- Number of operations
- Number of motor starts
- Motor ON-time, OFF-time
- Number of overload trips
- Number of thermistor trips
- Maximum currents
- Trip currents

Drive typicals

- Direct-on-line
- Reverse
- Star delta
- Star delta reverse
- Softstarter
- Softstarter reverse
- Dahlander
- Pole changing starter
- Solenoid valve
- Actuator

Approvals/Marking



SIL certified



ATEX certified



CE

Order information (see page A.77)

EntelliPro ES3 DP 2 2

ES3 = Standard device
ES5 = Medium device

2 = Power supply and 7 digital inputs, voltage 24V DC
3 = Power supply and 7 digital inputs, voltage 110-240V AC

0 = no additional 9 digital inputs available
2 = additional 9 digital input, voltage 24V DC
3 = additional 9 digital input, voltage 110-240V AC

Order codes ● pg. A.77
Technical data ● pg. A.78
Dimensions ● pg. A.80

Intelligent motor management relay

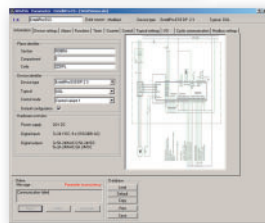

Type	Voltage	Ref. No.
Standard device (I/O 7 digital inputs / 3 digital outputs)		
EntelliPro ES3 DP 2 0	24V DC	720003
EntelliPro ES3 DP 3 0	240V AC	720004
Mid device (I/O 16 digital inputs / 8 digital outputs + 4-20 mA output)		
EntelliPro ES5 DP 2 2	24V DC / 24V DC	720005
EntelliPro ES5 DP 2 3	24V DC / 240V AC	720006
EntelliPro ES5 DP 3 3	240V AC / 240V AC	720007
Transformer		
EntelliPro CT8	1,4A - 8A	720022
EntelliPro CT32	5,4A - 32A	720023
EntelliPro CT64	10,7A - 64A	720024
EntelliPro CT630	105A - 630A	720025
HMI Control panel		
EntelliPro CP3	HMI 3,3" LCD	720028
EntelliPro CP5	HMI 7" color TFT-LCD	720029
Parameterizing user software		
WinESG V3	EntelliPro software tool for Windows	720020
Demonstration KIT		
Demo-case	Demonstration KIT for EntelliPro	720030

Order codes

Intro

A

B

C

D

E

F

G

H

I

J/X



New

Intelligent motor management relay

Overload tripping curves IEC 60947-4-1 (3-Pole / 3-Wire)

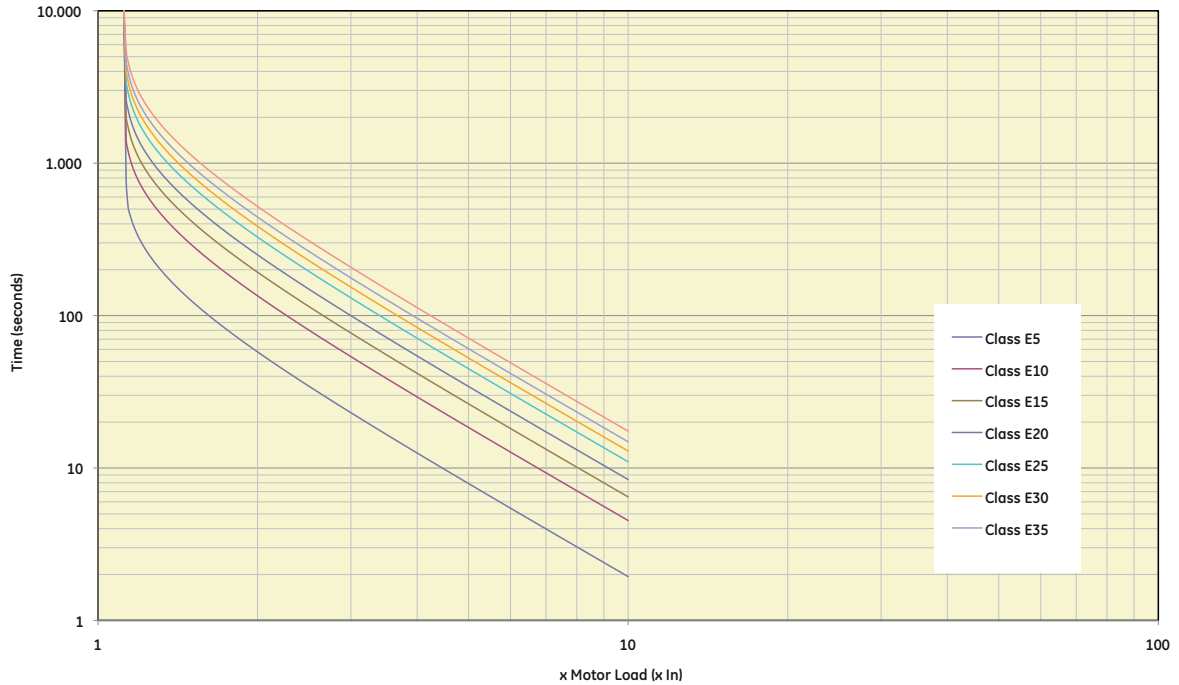

Current (x In)	Class E5 (sec)	Class E10 (sec)	Class E15 (sec)	Class E20 (sec)	Class E25 (sec)	Class E30 (sec)	Class E35 (sec)	Class E40 (sec)	Tolerance (%)
1.2	314.70	734.29	1048.99	1363.68	1783.28	2097.98	2412.67	2832.27	10
1.4	156.93	366.16	523.09	680.01	889.25	1046.17	1203.10	1412.83	10
1.6	103.43	241.33	344.75	448.18	586.08	689.50	792.93	930.83	10
1.8	75.21	175.49	250.70	325.91	426.19	501.40	576.61	676.90	10
2	57.80	134.86	192.66	250.46	327.53	385.33	443.12	520.19	10
2.5	34.41	80.29	114.70	149.11	194.99	229.40	263.81	309.69	10
3	23.26	54.10	77.85	101.91	133.65	155.70	178.76	209.50	10
3.5	16.79	39.02	56.31	73.91	97.03	112.62	129.22	151.34	10
4	12.74	29.56	42.80	56.34	74.06	85.60	98.14	114.86	10
4.5	10.02	23.22	33.74	44.56	58.66	67.48	77.30	90.40	10
5	8.11	18.75	27.36	36.26	47.81	54.71	62.62	73.16	10
5.5	6.71	15.48	22.68	30.19	39.86	45.37	51.87	60.55	10
6	5.65	13.01	19.10	24.31	31.97	37.52	43.16	50.43	10
6.5	4.83	11.10	16.43	20.76	27.33	32.06	36.89	43.06	10
7	4.18	9.59	13.40	17.96	23.67	27.76	31.94	37.25	10
7.2	3.90	9.08	12.78	17.00	22.42	26.28	30.25	35.26	10
8	3.20	7.39	10.40	13.88	18.33	21.47	24.71	28.76	20
9	2.60	5.89	8.40	11.09	14.68	17.18	18.90	22.98	20
10	2.30	5.20	7.40	9.10	12.19	14.13	16.27	18.85	20



Overload tripping curves IEC 60947-4-1 (2-Pole / 2-Wire)

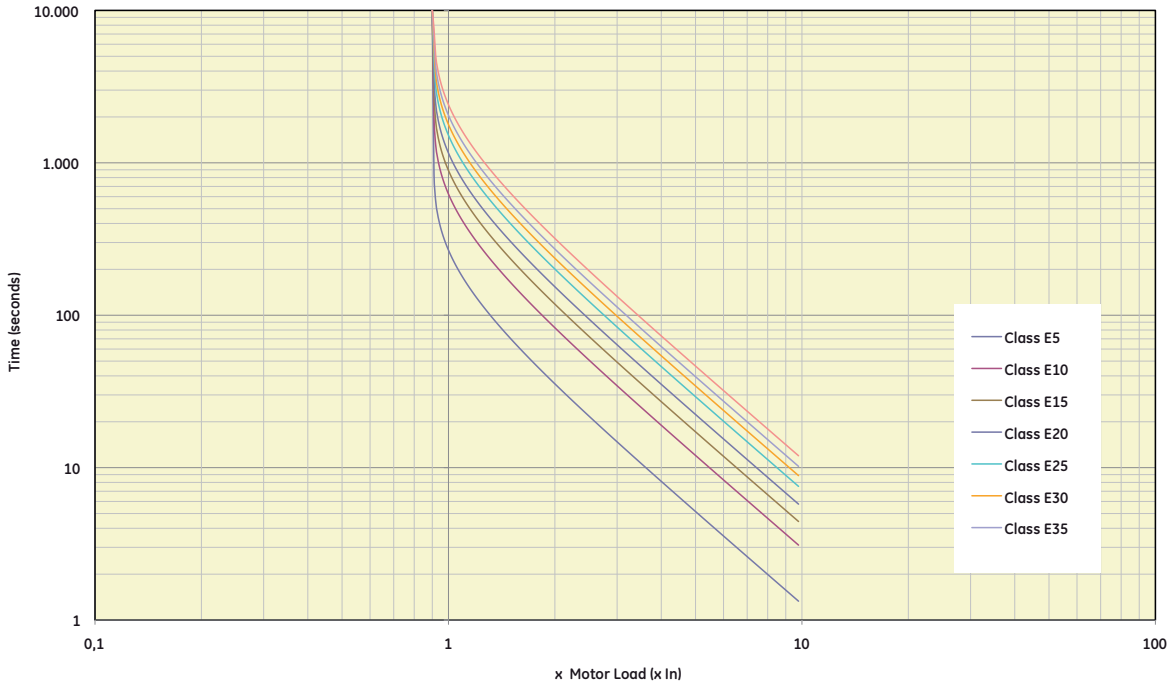

Current (x In)	Class E5 (sec)	Class E10 (sec)	Class E15 (sec)	Class E20 (sec)	Class E25 (sec)	Class E30 (sec)	Class E35 (sec)	Class E40 (sec)	Tolerance (%)
1	267.42	623.99	891.41	1158.83	1515.39	1782.81	2050.24	2406.80	10
1.2	130.59	304.72	435.31	565.91	740.03	870.63	1001.22	1175.35	10
1.4	83.87	195.69	279.56	263.43	475.25	559.12	642.98	754.81	10
1.6	59.72	139.35	199.07	258.79	338.42	398.14	457.88	537.48	10
1.8	45.12	105.27	150.39	195.51	255.67	300.78	345.90	406.06	10
2	35.46	82.75	118.21	153.67	200.96	236.42	271.88	319.17	10
2.5	21.73	50.71	72.45	94.18	123.16	144.90	166.63	195.61	10
3	14.76	34.44	49.20	63.97	83.65	98.41	113.17	132.85	10
3.5	10.70	24.98	35.68	46.39	60.66	71.36	82.07	96.34	10
4	8.13	18.97	27.09	35.22	46.06	54.19	62.32	73.15	10
4.5	6.39	14.90	21.29	27.67	36.19	42.57	48.96	57.48	10
5	5.15	12.02	17.17	22.33	29.20	34.35	39.50	46.37	10
5.5	4.25	9.91	14.15	18.40	24.06	28.30	32.55	38.21	10
6	3.56	8.31	11.86	15.42	20.17	23.73	27.29	32.04	10
6.5	3.03	7.06	10.09	13.12	17.16	20.18	23.21	27.25	10
7	2.80	6.30	8.79	11.70	15.47	17.88	20.94	24.36	10
7.2	2.60	6.05	8.42	11.09	14.66	16.92	19.83	23.07	10
8	2.20	4.90	6.80	9.14	12.09	13.78	16.22	19.04	20
9	1.75	3.80	5.66	7.21	9.61	10.98	13.00	15.05	20
10	1.66	3.50	5.30	6.39	7.87	8.98	12.19	14.01	20

Dimensional drawings

EntelliPro ES3/ES5

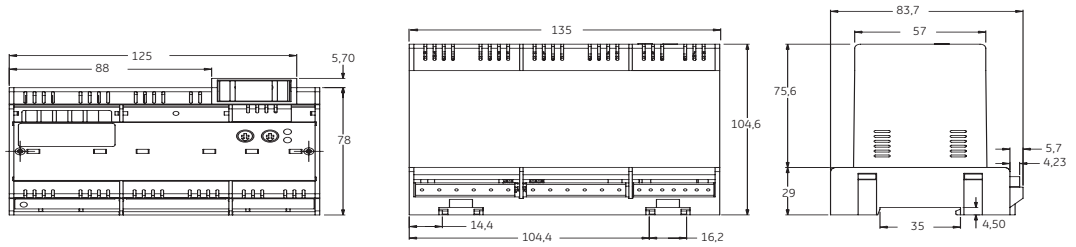

Transformers

CT 8 - CT 32 - CT 64

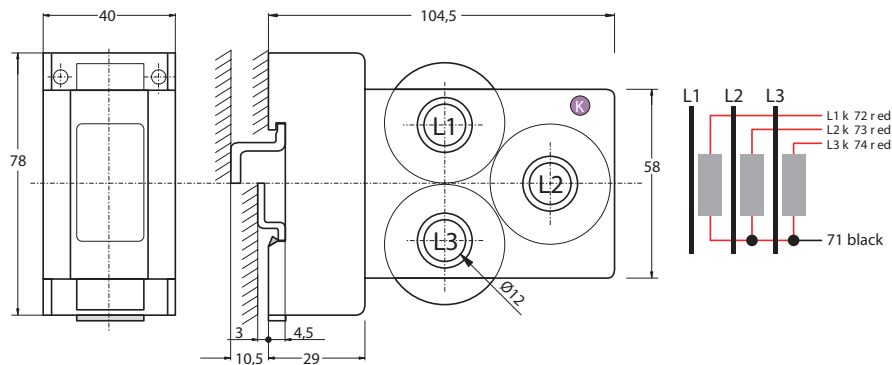

CT 630

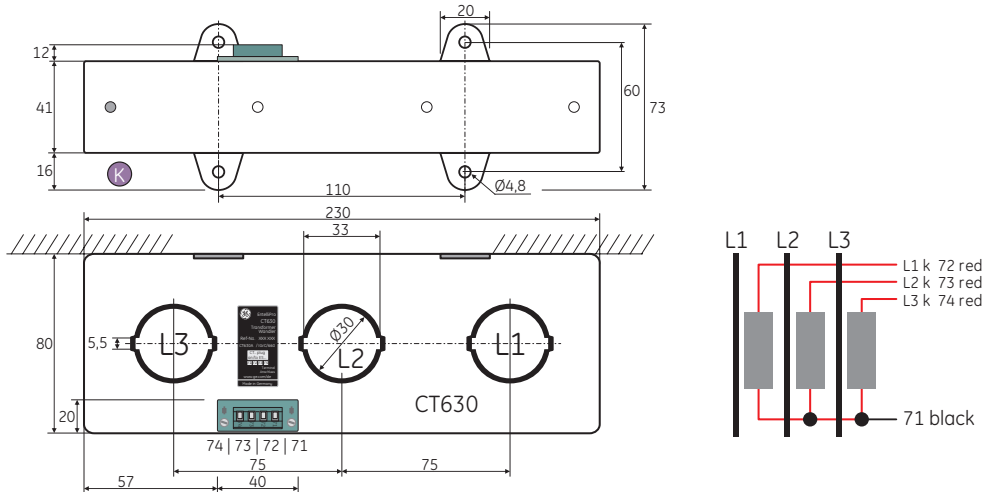

Control panel

CP3

Unit: mm

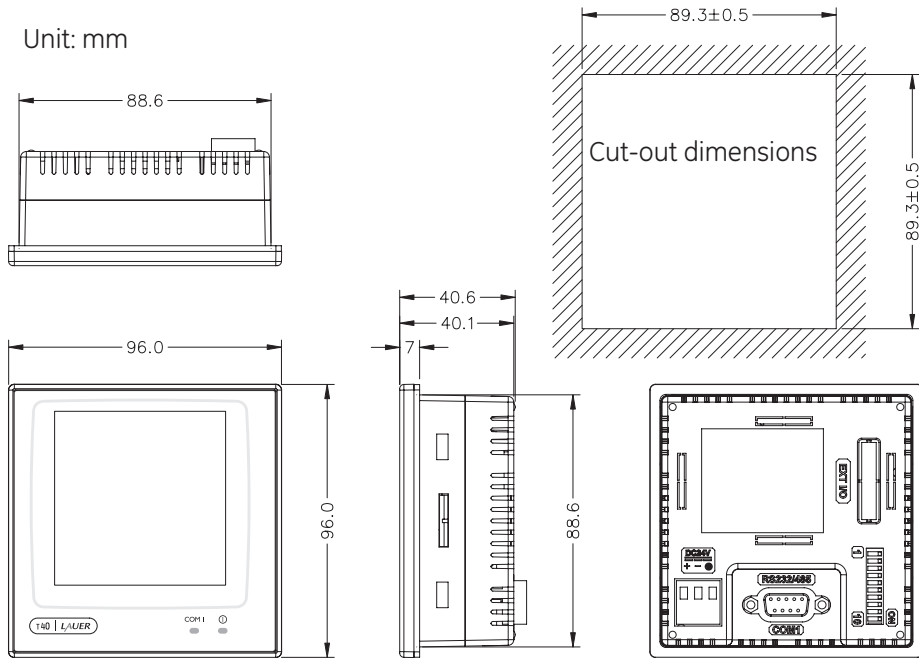

CP5

Unit: mm

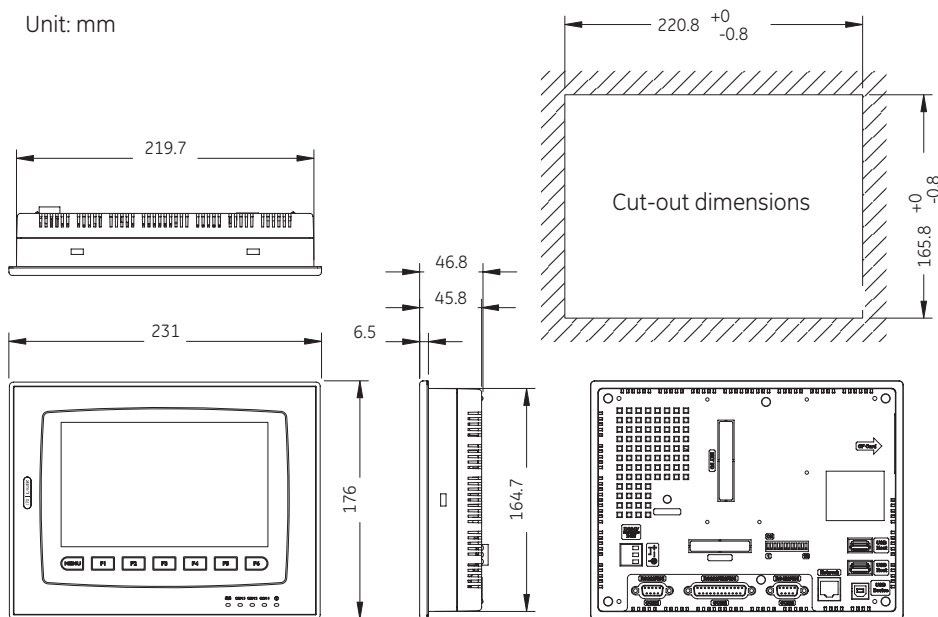

Dimensions

Intro

A

B

C

D

E

F

G

H

I

J/X

New



Notes

Contactors

Intro

A

B

C

D

E

F

G

H

I

J/X

Grid area for notes



Technical data

General

		MC1...	MC2...
Rated thermal current $I_{th} \theta \leq 60^{\circ}[1]$	(A)	20	20
Rated operational current $I_e^{[2]}$	(A)	9	12
(3 x 440V, 50/60Hz, AC-3)			
Maximum number of poles		4	4
Rated insulation current U_i	(V)	750	750
Rated operational current U_e	(V)	690	690

(1) Insulated terminal type B 2.8 x 0.8 with wire 1 mm²:

$I_e = 8A$, design DIN 46 247

(2) Max.operational current AC3, 3 -phases $\leq 440V$, according to IEC 947-4-1

Conformity to standards

IEC/EN 60947-1	CSA C22.2/14	SEV 10254
IEC/EN 60947-4-1	CENELEC HD 419	JIS C8325
IEC/EN 60947-5-1	VDE 0660	JEM 1038
EN 50003	NFC 63110	NEMA ICS-1
EN 50005	BS 4794	UL 508
EN 50012		

Approvals

cULus	NEMKO	SEMKO
SETI	DEMKO	RINA
IMQ		
Lloyd's Register	Bureau Veritas	CE

Ambient conditions

Storage temperature		-55°C to +80°C
Operation temperature		-40°C to +55°C
Altitude	up to 3000m	Nominal values
	from 3000 up to 4000m	90% I_e 80% U_e
	from 4000 up to 5000m	80% I_e 75% U_e

Climatic resistance

Continuous tests 40 / 125 / 56		
Cold (72h)	Temperature	-40°C
	Relative humidity	< 50%
Dry heat (96h)	Temperature	+125°C
	Relative humidity	< 50%
Humid heat (56h)	Temperature	+40°C
	Relative humidity	95%
Cyclic tests		
First half-cycle (12h)	Low temperature	+25°C
	Relative humidity	93%
Second half-cycle (12h)	Low temperature	+55°C
	Relative humidity	95%
Number of consecutive cycles		6

Shock resistance (IEC 68-2-27)

Continuously closed (at 0.8Us)	
Admissible acceleration	25 g
Impulse duration	11 ms
Continuously opened (no voltage)	
Admissible acceleration	20 g
Impulse duration	11 ms

Vibration resistance (IEC 68-2-6)

Continuously closed (at 0.8Us)	
Admissible acceleration	15 g
Sweep between	10 - 200 Hz
Continuously opened (no voltage)	
Admissible acceleration	5g (AC) - 35g (DC)
Sweep between	10 - 200 Hz

Mounting positions

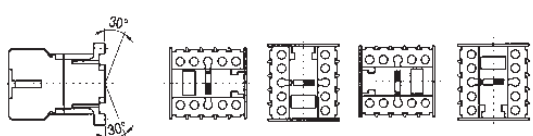

With the same pick-up and drop-out voltage
With the same rated power

-7% of connection voltage
+4% of disconnection voltage
With the same rated power

7% of connection voltage
+4% of disconnection voltage
With the same rated power

Terminal capacity

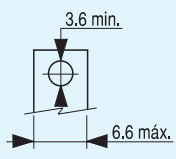
Terminal with M3.5 screw (with pozidrive head and safety flange)		Tightening torque
		0.8 Nm - 7 Lb/in
Solid wire	mm ²	0.75 to 2 x 2 w.
Flexible wire without terminal	mm ²	0.75 to 2.5 x 2 w.
Flexible wire without terminal with cap	mm ²	0.75 to 2.5 x 1 w.
	mm ²	0.75 to 1 x 2 w.
Ring terminal		0.8 Nm - 7 Lb/in
		
Faston terminal 2.8 - 2 insulated terminals	mm ²	1 x 2 w.
Terminal for printed circuit (\varnothing of PCB hole)		1.8 mm
Ring terminal cap		7.8 mm
Fork terminal cap		6.5 mm

Control circuit

		MC_A...	MC_C...	MC_I...	MC_K...	MC_C...W
Rated insulation voltage (Ui)	(V)	750	750	750	750	750
Standard voltages (Us)						
50Hz(V)		24 ... 690	-	-	-	-
60Hz(V)		6 ... 600	-	-	-	-
DC	(V)	-	6 ... 440	24	24	12 ... 440
Operating voltages limits						
Operating ⁽¹⁾	xUs	0.8 ... 1.1	0.8 ... 1.1	0.8 ... 1.25	0.7 ... 1.25	0.7 ... 1.3
Drop-out	xUs	0.35 ... 0.55	0.15 ... 0.4	0.15 ... 0.3	0.15 ... 0.35	0.15 ... 0.3
Operating voltages limits with coil 50/60 Hz						
Operating	xUs	0.8 ... 1.1	-	-	-	-
Drop-out	xUs	0.35 ... 0.55	-	-	-	-
Consumption						
50 or 60Hz - monofrequency coil						
Pick-up	(VA)	26	-	-	-	-
Seal	(VA)	4	-	-	-	-
50/60Hz - bifrequency coil						
Pick-up	(VA)	32	-	-	-	-
Seal	(VA)	6	-	-	-	-
DC	(W)	-	3	1.2	2	4
Power factor						
Magnetic circuit open	(cos φ)	0.8	-	-	-	-
Magnetic circuit closed	(cos φ)	0.35	-	-	-	-
Power dissipation	(W)	1.4	3	1.2	2	4
Opening and closing times						
Values between ± %Us						
Time on energisation NO	(ms)	6 ... 13	22 ... 36	30 ... 70	20 ... 50	17 ... 28
Time on de-energisation NC	(ms)	8 ... 16	9 ... 12	9 ... 16	9 ... 16	9 ... 12
Time on energisation NC	(ms)	5 ... 11	18 ... 27	20 ... 45	18 ... 35	12 ... 25
Time on de-energisation NO	(ms)	6 ... 13	5 ... 7	5 ... 9	5 ... 9	5 ... 7
Values at Us						
Time on excitation NO	(ms)	7 ... 12	24 ... 27	25 ... 45	25 ... 40	11 ... 23
Time on desexcitation NC	(ms)	8 ... 16	9 ... 11	9 ... 16	9 ... 16	9 ... 11
Time on excitation NC	(ms)	6 ... 10	20 ... 26	25 ... 35	20 ... 30	15 ... 21
Time on desexcitation NO	(ms)	6 ... 13	5 ... 8	5 ... 9	5 ... 8	5 ... 8
Maximum time without voltage	(ms)	3	3	3	3	3
Mechanical endurance						
Monofrequency coil	10 ⁶ ops.	>15	-	-	-	-
Bifrequency coil	10 ⁶ ops.	>10	-	-	-	-
DC	10 ⁶ ops.	-	10	10	10	10
Maximum rate						
No load	Monofrequency coil	ops./h	9000	-	-	-
	Bifrequency coil	ops./h	3600	-	-	-
	DC	ops./h	-	9000	9000	9000
AC1 and AC3 (at rated power)	ops./h	1200	1200	1200	1200	1200
AC4 (at rated power)	ops./h	300	300	300	300	300



Main circuit (poles)

		MC1...	MC2...
Rated insulation voltage (Ui) (acc. IEC 947-4)	(V)	750	750
Rated thermal current (Ith) $\theta \leq 60^\circ$ (1)	(A)	20	20
Frequency limits	(Hz)	0...400	0...400
Making capacity (r.m.s.) $U_e \leq 690V$ 50/60Hz	(A)	160	160
Breaking capacity (r.m.s.) $U_e \leq 440V$	(A)	106	106
$U_e = 500V$	(A)	90	90
$U_e = 690V$	(A)	80	90
Short-time current			
0.3 sec.	(A)	470	470
1 sec.	(A)	250	250
5 sec.	(A)	125	125
10 sec.	(A)	95	95
30 sec.	(A)	70	70
1 min.	(A)	50	50
3 min.	(A)	40	40
Recovery time	min.	10	10
Protec. against short-circuits (IEC 947-4). w/o TOR			
Coordination type "1" gL/gG	(A)	32	32
Coordination type "2" gL/gG	(A)	20	20
w/o welding contacts gL/gG	(A)	16	16
Circuit breaker rating (curve G CEE 19.1)		20	20
Impedance per pole	(m Ω)	1.5	1.5
Power dissipation per pole			
AC1	(W)	0.6	0.6
AC3	(W)	0.128	0.228
Insulation resistance			
Between adjacent poles	(m Ω)	> 10	> 10
Between pole and earth	(m Ω)	> 10	> 10
Between input and output	(m Ω)	> 10	> 10
Guaranteed no overlap between NO and NC contacts			
Space	(mm)	1	1
Time	(ms)	> 2	> 2

(1) Insulated terminal type B 2.8 x 0.8 with wire 1 mm² Ie = 8A acc. to DIN 46247

Electrical endurance

Category AC1

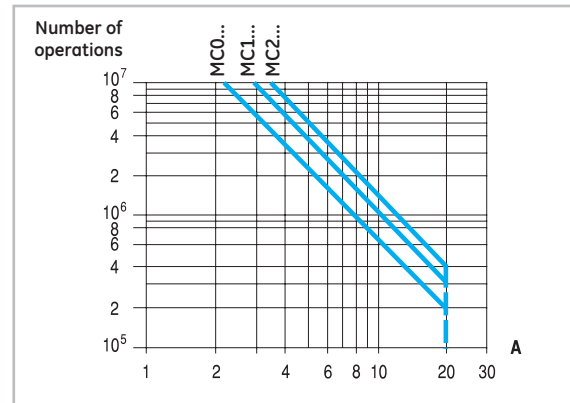

Category AC3

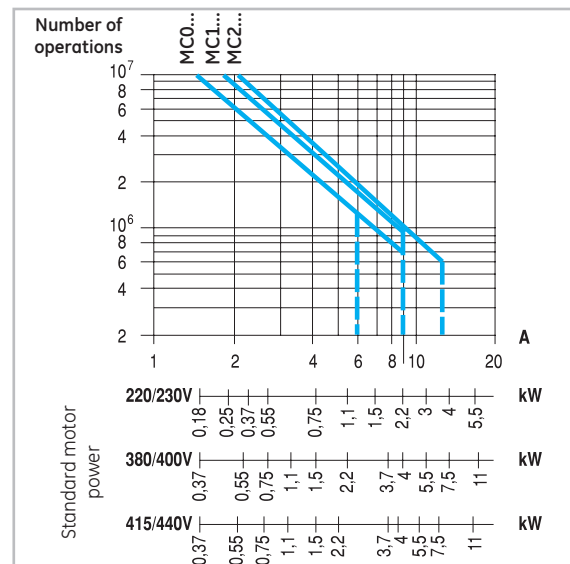

Category AC4

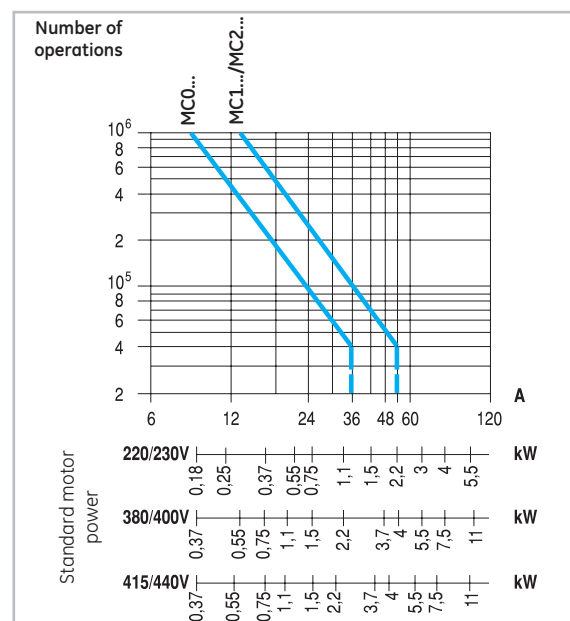

Internal auxiliary contacts

	MC1 / MC2
Rated insulation voltage (Ui) IEC 60947-5 (V)	750
Rated thermal current (Ith) $\theta \leq 60^\circ\text{C}$ (A)	16
Making capacity according with IEC 60947-5-1	
Ue \leq 690 50-60 Hz (A)	160
Ue \leq 440V DC (A)	160
Breaking capacity (r.m.s.) IEC 60947-5-1	
AC-15	
Ue \leq 440V / 50-60 Hz (A)	106
DC-13	
Ue \leq 110V DC (A)	3
Ue = 220V DC (A)	1.2
Ue = 48V DC (A)	10
Minimum operational power (operational safety.)	5mA, 17V
Short-circuit protection (max.class gl fuse) w/o welding	(A) 10
Insulation resistance	
Between adjacent contacts (m Ω)	> 10
Between contacts and earth (m Ω)	> 10
Between input and output (m Ω)	> 10
Guaranteed no overlap between NO and NC contacts	
Space (mm)	0.5
Minimal time (ms)	> 2
Impedance (m Ω)	2.3
Terminal capacity	Same as main circuit

(1) Insulated terminal type B 2.8 x 0.8 with wire 1 mm² Ie = 8A acc. with DIN 46247

Tripping characteristics (AC)

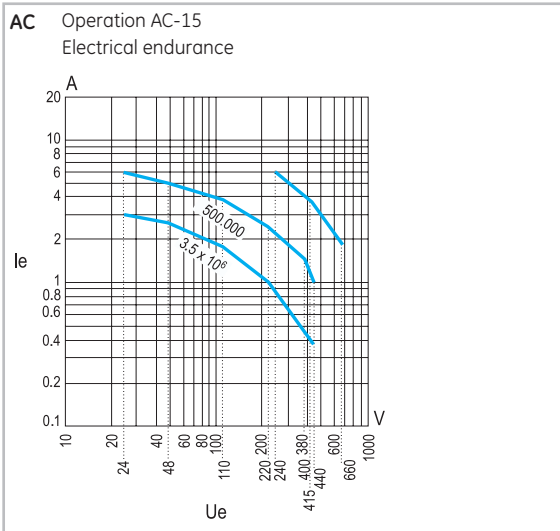

Tripping characteristics (DC)

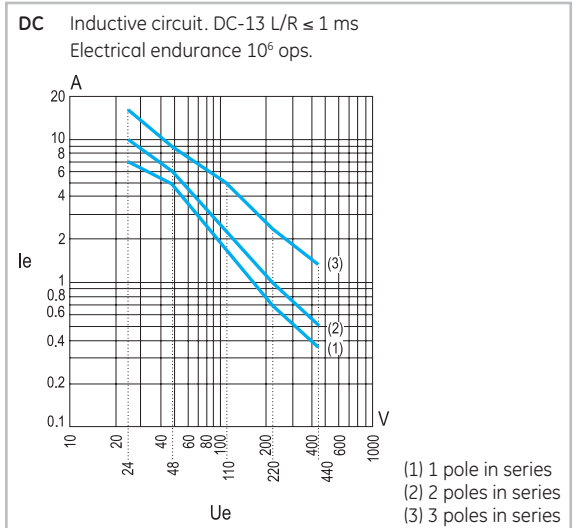
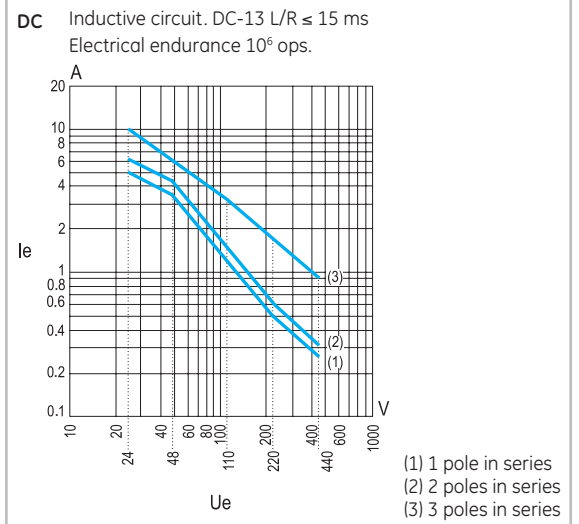
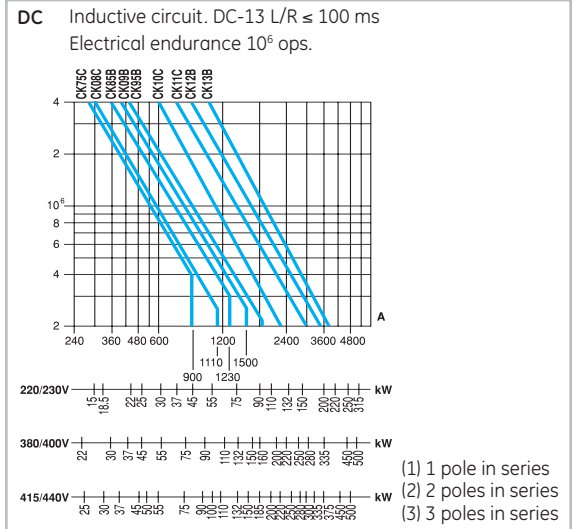

Instantaneous auxiliary contact blocks

		MACN..., MACL...
Rated insulation voltage (Ui) acc. IEC 60947-1	(V)	750
Rated thermal current (Ith) $\theta \leq 60^\circ\text{C}$ (1)	(A)	10
Making capacity (r.m.s.) according with IEC/EN 60947-5-1		
AC-15	Ue \leq 220V 50/60 Hz	(A) 73
	Ue = 380V 50/60 Hz	(A) 38
	Ue = 690V 50/60 Hz	(A) 22
DC-13	Ue \leq 100V DC	(A) 2.6
	L/R=100ms Ue = 220V DC	(A) 1
	Ue = 440V DC	(A) 0.6
Breaking capacity (r.m.s.) acc. IEC/EN 60947-5-1		
AC-15	Ue \leq 220V 50/60 Hz	(A) 73
	Ue = 380V 50/60 Hz	(A) 38
	Ue = 690V 50/60 Hz	(A) 22
DC-13	Ue \leq 100V DC	(A) 2
	LR=100ms Ue = 220V DC	(A) 0,8
	Ue = 440V DC	(A) 0.4
Rated voltage and rated current Ue-Ie		
AC-15	according to IEC 60947	120V - 6A
		230V - 6A
		400V - 4A
		500V - 1A
		600V - 1A
		according to UL, CSA
DC-13	according to IEC 60947	24V - 4A
		48V - 2A
		110V - 0.7A
		220V - 0.3A
		440V - 0.1A
		according to UL, CSA
Minimum operational power (operational safety)		5 mA, 17V
Short-circuit protection (max. class gI fuse) w/o welding	(A)	10
Insulation resistance		
Between adjacent contacts	(m Ω)	> 10
Between contacts an earth	(m Ω)	> 10
Between input and output	(m Ω)	> 10
Guaranteed no overlap between NO and NC contacts		
Space	(mm)	0,5
Minimal time	(ms)	> 2
Impedance	(m Ω)	2.4
Terminal capacity		Same as main circuit

(1) Insulated terminal type B 2.8 x 0.8 with wire 1 mm² Ie = 8A acc. with DIN 46247

Tripping characteristics (AC)

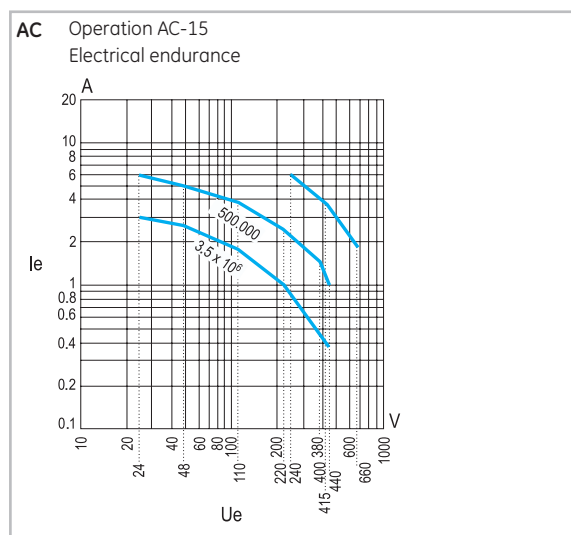

Tripping characteristics (DC)

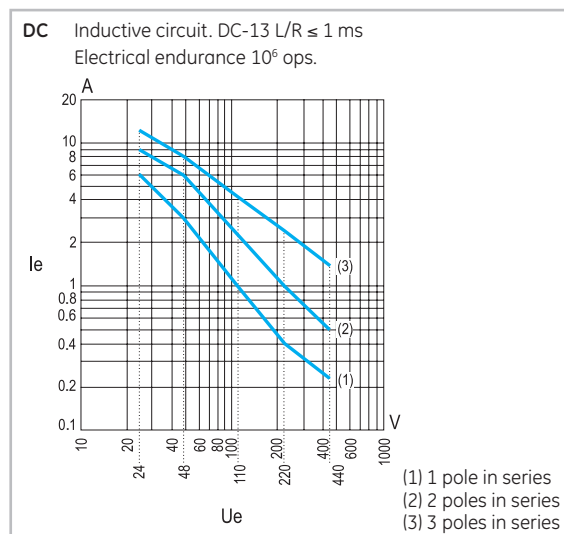
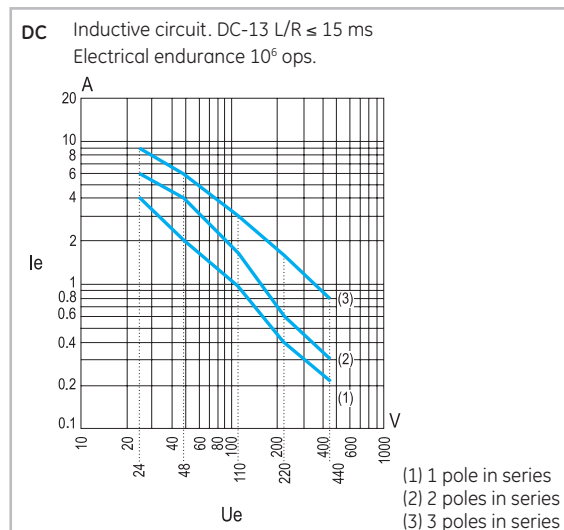
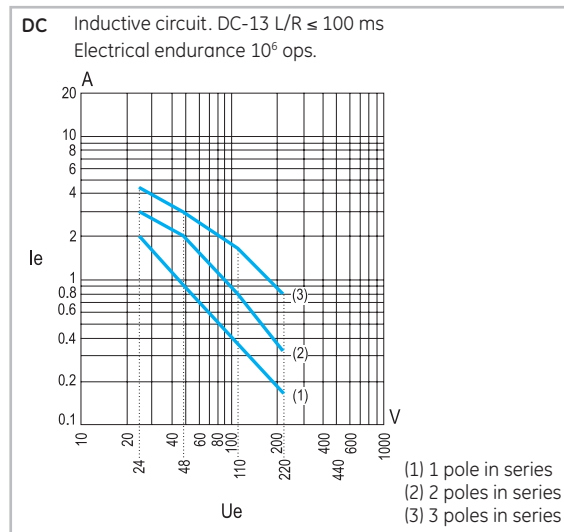

Electronic timer block



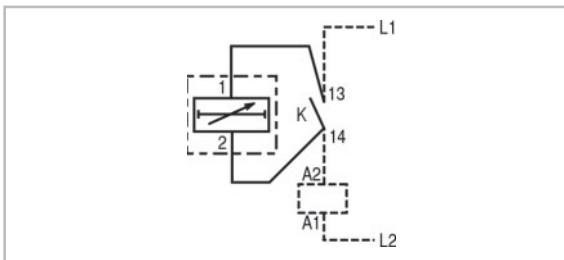









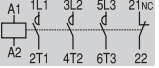

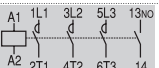

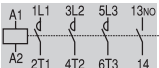

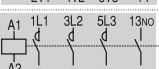

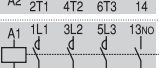

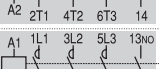

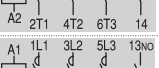

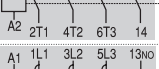

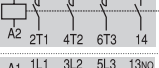
		MREBC...
Rated insulation voltage (U _i)	(V)	750
Rated thermal current (I _{th}) θ ≤ 60°C ⁽¹⁾	(V)	0.55
Supply voltage (AC and DC)	(V)	24 to 250
Operating limits		0.80 to 1.1 U _s (0.85 to 1.1 U _s to 12V)
Voltage drop	(V)	< 3
Maximum load current at :		
20°C	(A)	0.9
40°C	(A)	0.72
60°C	(A)	0.55
Minimum load for safe operation	(A)	> 10
Maximum current	(A)	10A per 40 ms
Leakage current at 220V	(mA)	< 5
Operational current		
AC-15	(A)	0.7
DC-13	(A)	0.9
Timing range (delay ON)	(s)	0.5 to 60 (± 6 s)
Rearrangement time	(ms)	< 100
Repeatability (accuracy) (%)		± 1
Ambient temperature		
storage	(°C)	-55 to +80
operation	(°C)	-5 to +60
Degree of protection		IP20
Mounting positions		Any
Terminals : 2 free cables		1 mm ² (AWG 17) 250 mm

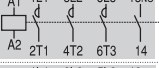

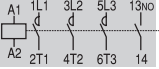
Contact sequence

	Main contact (NO)	Main contact (NC)	Auxiliary contact (NO)	Auxiliary contact (NC)
Three-pole minicontactor				
MC...310...				
MC...301...				
Four-pole minicontactor				
MC...400...				
MC...B00...				
MC...A00...				
Auxiliary contact block				
MAC...				
MAR...				

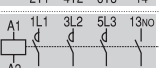
Terminal numbering in accordance with EN 50012

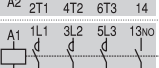
Final structure of the contactor	Auxiliary contactors		Possible basic contactors + Auxiliary contact blocks to be added
	Combination	 	
	Description		
Without auxiliary contact blocks			
 	01E	0 1	MC_A301A...
 	10E	1 0	MC_A310A...
Auxiliary contact blocks front mounted with two or four contacts			
 	11E	1 1	MC_A310A... + MACN211A
 	21E	2 1	MC_A310A... + MACN211A
 	12E	1 2	MC_A310A... + MACN202A
 	31E	3 1	MC_A310A... + MACN431A
 	41E	4 1	MC_A310A... + MACN431A
 	22E	2 2	MC_A310A... + MACN422A
 	32E	3 2	MC_A310A... + MACN422A
 	13E	1 3	MC_A310A... + MACN413A
 	23E	2 3	MC_A310A... + MACN413A
Auxiliary contact blocks lateral mounted with one contact			
 	11E	1 1	MC_A310A... + MACL101A
 	21E	2 1	MC_A310A... + MACL101A + MACL110A
 	12E	1 2	MC_A310A... + MACL101A + MACL101A

Terminal numbering

Basic three-pole contactors. (EN 50012)

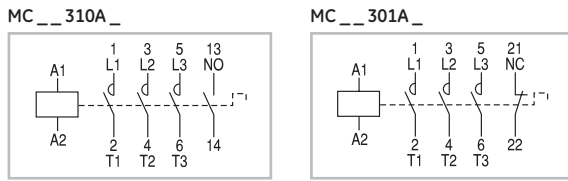

Instantaneous auxiliary contact blocks. (EN 50012)

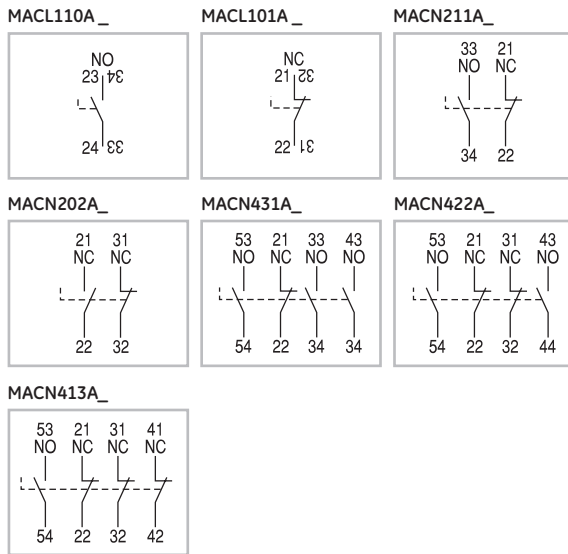

Instantaneous auxiliary contact blocks. (EN 50005)

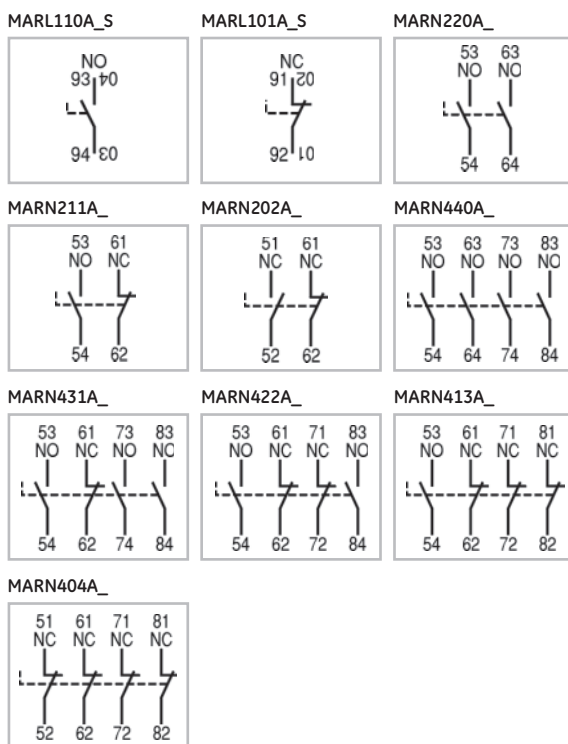

Base four-pole contactors. (EN 50005)

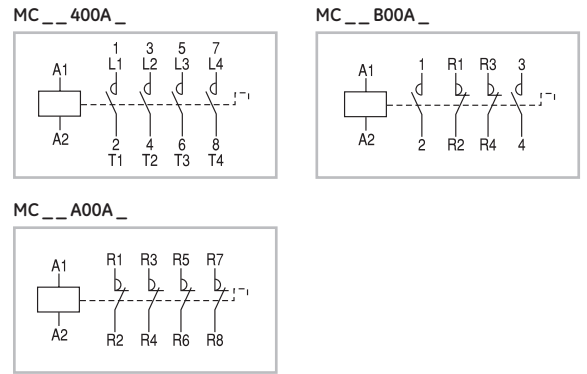

Instantaneous auxiliary contact blocks. (EN 50005)

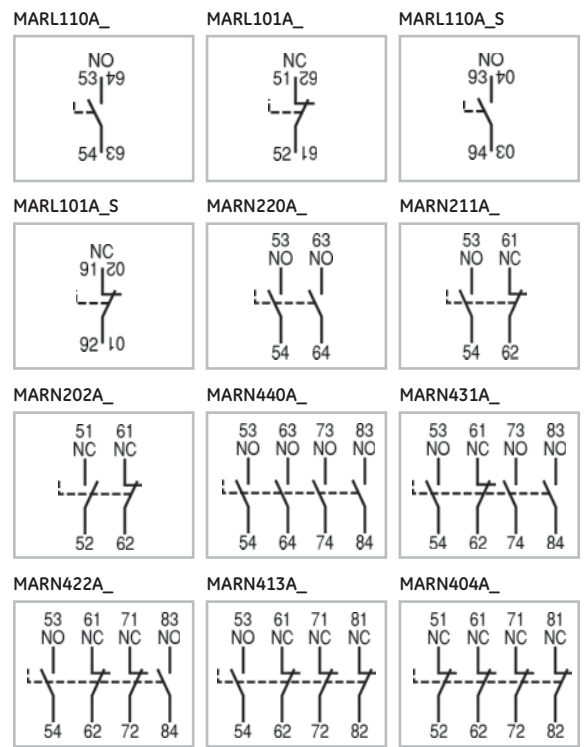

Voltage suppressor block

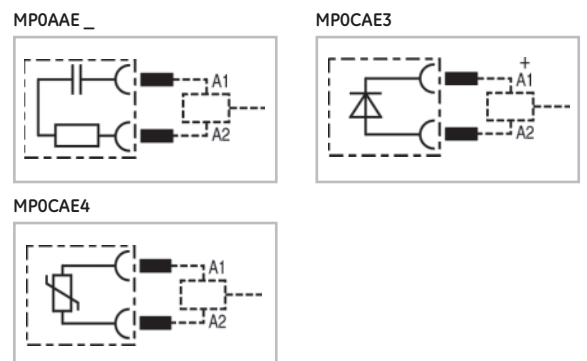

Conformity to standards

IEC/EN 60947-1	EN 50005	UNE 20109
IEC/EN 60947-4-1	CENELEC HD419	BS 5424 & 775
IEC/EN 60947-5-1	NF C63-110	NEMA ICS 1
UL 508	ASE 1025	VDE 0660/102
CSA 22.2/14		

Approvals

cULus	RINA	CE
SETI	IMQ (up to Ith:32A)	
Lloyd's Register	Bureau Veritas	

Ambient conditions

Storage temperature	-55°C to +80°C	
Operation temperature	-40°C to +55°C	
Altitude	up to 3000m	Nominal values
	from 3000 up to 4000m	90%le 80%Ue
	from 4000 up to 5000m	80%le 75%Ue

Climatic resistance (IEC 68-2)

Continuous tests 40 / 125 / 56	Cyclic test (6 cycles)
Cold (72h)	Humid heat
Temperature -40°C	First half-cycle (12h)
Dry heat (96h)	Low temperature +25°C
Temperature +125°C	Relative humidity 93%
Relative humidity < 50%	Second half-cycle (12h)
Humid heat (56h)	Low temperature +55°C
Temperature +40°C	Relative humidity 95%
Relative humidity 95%	

Mounting positions

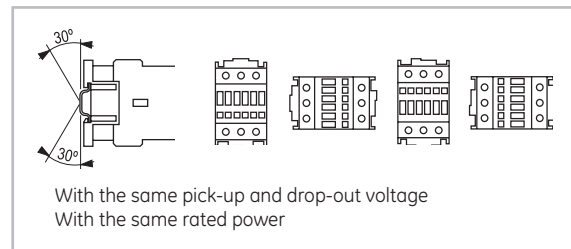

Terminal capacity and tightening torque

		CL00 ... CL02	CL25	CL03 ... CL04	CL45	CL05 ... CL08	CL09 ... CL10
	Solid, stranded and finely stranded without end sleeve (mm ²)	2 x 0.5 ... 2.5	2 x 0.5 ... 2.5	-	-	-	-
	Finely stranded with or without end sleeve (mm ²)	2 x 1 ... 2.5	2 x 1 ... 2.5	-	-	-	-
	AWG wires	2 x 20 ... 12	2 x 20 ... 8	-	-	-	-
	Tightening torque (Nm)	1.6	2.2	-	-	-	-
	(Lb x in.)	15	20	-	-	-	-
	Solid, stranded and finely stranded without end sleeve (mm ²)	-	-	0.75 ... 16	0.75 ... 16	1 ... 35	1.5 ... 50
	Finely stranded with end sleeve (mm ²)	-	-	0.75 ... 16	0.75 ... 16	1 ... 35	1.5 ... 50
	Finely stranded w/o end sleeve (mm ²)	-	-	1 ... 16	1 ... 16	1 ... 35	1.5 ... 50
	AWG wires	-	-	18 ... 6	18 ... 6	16 ... 2	16 ... 2
	Tightening torque (Nm)	-	-	1.4	1.8	4	5.6
	(Lb x in.)	-	-	12	16	35	50
	Solid (mm ²)	-	-	0.75 ... 16	0.75 ... 16	1 ... 16	4 ... 35
	Stranded (mm ²)	-	-	0.75 ... 16	0.75 ... 16	1 ... 25	4 ... 35
	Finely stranded w/o end sleeve (mm ²)	-	-	0.75 ... 16	0.75 ... 16	1 ... 25	4 ... 35
	Finely stranded with end sleeve (mm ²)	-	-	1 ... 16	1 ... 16	1 ... 25	4 ... 35
	AWG wires	-	-	18 ... 6	18 ... 6	16 ... 4	10 ... 1
Tightening torque (Nm)	-	-	1.4	1.8	4	5.6	
	(Lb x in.)	-	-	12	16	35	50
	Solid, stranded and finely stranded without end sleeve (mm ²)	-	-	Max. 16	Max. 16	Max. 50 ... 4	Max. 50 ... 35
	Finely stranded w/o end sleeve (mm ²)	-	-			Max. 25 ... 16	
	Finely stranded with end sleeve (mm ²)	-	-			Max. 25 ... 16	
	AWG wires	-	-	Max. 6	Max. 6	Max. 25 ... 25	Max. 1
Tightening torque (Nm)	-	-	1.4	1.8	4	5.6	
	(Lb x in.)	-	-	12	16	35	50
	Ring terminals (Ø i) (A)	3,6	4,2	4,2	4,2	6,2	6,2
	(acc. with IEC/EN 60947-1)	8	10	10	10	12,5	12,5
	Tightening torque (Nm)	1,6	1,4	1,4	1,4	3	3
	(Lb x in.)	15	12	12	12	26	26

Power circuit

		CL00	CL01	CL02	CL25	CL03	CL04	CL45	CL05	CL06	CL07	CL08	CL09	CL10
Three pole version														
Rated thermal current I _{th} at θ ≤ 55°C (A)		25	25	32	45	45	60	60	-	90	110	110	140	140
Rated operational current I _e AC-3 (A)		9	12	18	25	25	32	40	-	50	65	80	95	105
Rated operational voltage U _e (V)		690	690	690	690	690	690	690	-	690	690	690	690	690
Four pole version (4NO and 2NO+2NC)														
Rated thermal current I _{th} at θ ≤ 55°C (A)		-	25	32	-	45	60	-	90	-	110	110	140	-
Rated operational voltage U _e (V)		-	690	690	-	690	690	-	690	-	690	690	690	-
Three and four pole version														
Rated insulation voltage U _i (V)		1000	1000	1000	1000	1000	1000	1000	1000	1000	1000	1000	1000	1000
Maximum continuous current AC-1 (A)		25	25	32	45	45	60	60	90	90	110	110	140	140
Frequency limits (Hz)		25..400	25..400	25..400	25..400	25..400	25..400	25..400	25..400	25..400	25..400	25..400	25..400	25..400
Making capacity (RMS) (IEC 947) (A)		450	450	450	450	550	550	550	1000	1000	1000	1000	1280	1280
Breaking capacity (RMS) (IEC 947)														
U _e ≤ 400V (A)		250	250	250	350	450	450	450	920	920	920	920	1050	1050
U _e = 500V (A)		250	250	250	320	450	450	450	920	920	920	920	1050	1050
U _e = 690V (A)		130	130	130	170	205	205	205	780	780	780	780	950	950
Short-time current														
1 sec. (A)		455	455	570	630	1010	1010	1265	1580	1580	2530	2530	3300	3300
5 sec. (A)		205	205	254	280	450	450	450	565	710	1130	1130	1485	1485
10 sec. (A)		144	144	180	200	320	320	400	500	500	800	800	1050	1050
30 sec. (A)		85	85	104	115	185	185	230	290	290	460	460	600	600
1 min. (A)		60	60	74	80	130	130	165	205	205	325	325	430	430
3 min. (A)		35	35	46	50	90	90	100	120	120	185	185	250	250
Recovery time (min.)		10	10	10	10	10	10	10	10	10	10	10	10	10
Protec. against short-circuit with fuses without TOR														
Coordination type "1"														
gL/gG (A)		50	50	63	63	100	100	125	200	200	200	200	250	250
Coordination type "2"														
gL-gG (A)		25	35	35	50	63	63	80	100	100	125	125	160	200
Without welding														
gL-gG (A)		10	10	25	35	35	35	50	80	80	100	100	140	160
Impedance per pole (mΩ)		2.35	2.35	2.41	1.65	1.28	1.28	0.95	0.85	0.85	0.86	0.86	0.76	0.76
Power dissipation per pole														
AC-1 (W)		1.47	1.47	2.46	3.34	2.59	4.6	3.42	6.89	6.86	10.40	10.40	14.89	14.89
AC-3 (W)		0.19	0.34	0.78	1.03	0.80	1.31	1.52	1.36	2.12	3.63	5.5	6.86	8.37
Insulation resistance														
Between adjacent poles (mΩ)		>10	>10	>10	>10	>10	>10	>10	>10	>10	>10	>10	>10	>10
Between poles and earth (mΩ)		>10	>10	>10	>10	>10	>10	>10	>10	>10	>10	>10	>10	>10
Between input and output (mΩ)		>10	>10	>10	>10	>10	>10	>10	>10	>10	>10	>10	>10	>10

Intro

A

B

C

D

E

F

G

H

I

J/X



Control circuit

		CL00 ... CL25	CL03 ... CL45	CL05 ... CL08	CL09 ... CL10
Alternating current					
Rated insulation voltage U_i	(V)	1000	1000	1000	1000
Standard voltages U_s 50 Hz	(V)	24...690	24...690	24...690	24...690
Standard voltages U_s 60 Hz	(V)	24...600	24...600	24...600	24...600
Voltage operating limits monofrequency coils					
Operating	xUs	0.8...1.1	0.8...1.1	0.8...1.1	0.8...1.1
Pick-up	xUs	0.6...0.8	0.65...0.8	0.65...0.8	0.65...0.8
Seal	xUs	0.35...0.55	0.4...0.6	0.4...0.6	0.4...0.6
Voltage operating limits 50/60 Hz coils					
Operating 50 Hz	xUs	0.8...1.1	0.8...1.1	0.8...1.1	0.8...1.1
Operating 60 Hz	xUs	0.85...1.1	0.85...1.1	0.85...1.1	0.85...1.1
Pick-up 50 Hz	xUs	0.5...0.8	0.6...0.8	0.6...0.8	0.6...0.8
Pick-up 60 Hz	xUs	0.65...0.85	0.7...0.85	0.7...0.85	0.7...0.85
Seal 50 Hz	xUs	0.3...0.55	0.35...0.60	0.35...0.60	0.35...0.60
Seal 60 Hz	xUs	0.35...0.65	0.4...0.6	0.4...0.6	0.4...0.6
Consumption monofrequency coils					
Magnetic circuit closed	(VA)	6	9	15.5	15.5
Magnetic circuit opened (VA)		48	88	190	190
Consumption bifrequency coils					
Magnetic circuit closed (50 Hz/60 Hz)	(VA)	6.8 / 5.6	11.4 / 9.5	20 / 16.6	20 / 16.6
Magnetic circuit opened (50 Hz/60 Hz)	(VA)	53 / 44	120 / 100	245 / 204	245 / 204
Thermal power dissipation (50 Hz/60 Hz)	(W)	2.2 / 1.8	3.2 / 2.6	5.2 / 4.3	5.2 / 4.3
Power factor					
Magnetic circuit closed	cos φ	0.33	0.28	0.26	0.26
Magnetic circuit opened	cos φ	0.84	0.73	0.54	0.54
Opening and closing times					
Values between + 10 % U_s and - 20 % U_s					
Time on energisation (NO)	(ms)	6...20	7...25	9...35	9...35
Time on de-energisation (NO)	(ms)	6...13	5...25	9...15	9...15
Values at U_s					
Time on energisation (NO)	(ms)	8...20	10...19	15...30	15...30
Time on de-energisation (NO)	(ms)	6...13	5...25	9...15	9...15
Mechanical endurance					
Monofrequency coils	10 ⁶ ops.	15	15	15	15
Bifrequency coils (at 50 Hz)	10 ⁶ ops.	10	10	8	8
Maximum rate					
Monofrequency coils. No load	ops./h	9000	9000	9000	5000
AC-1 at rated power	ops./h	1200	1200	1200	1200
AC-2 at rated power	ops./h	1000	1000	1000	750
AC-3 at rated power	ops./h	1200	1200	1200	600
AC-4 at rated power	ops./h	360	360	200	200
Bifrequency coils. No load	ops./h	3600	3600	3600	3600

		CL00D ... CL25D		Coils with electronic module		Coils with wide voltage range		
		CL00D ... CL25D	CL03D ... CL45D	CL05E ... CL08E	CL09E ... CL10E	CL00D..W ... CL25D..W	CL03D..W ... CL45D..W	CL05D..W ... CL10D..W
Direct current								
Rated insulation voltage U_i	(V)	1000	1000	1000	1000	1000	1000	1000
Standard voltages U_s	(V)	12...440	12...440	24...440	24...440	12...440	12...440	12...440
Operating limits								
Operating	xUs	0.8...1.1	0.8...1.1	0.8...1.1	0.8...1.1	0.7...1.3	0.7...1.3	0.7...1.3
Pick-up	xUs	0.45...0.65	0.45...0.65	0.70...0.80	0.70...0.80	0.45...0.55	0.45...0.55	0.45...0.55
Drop-out	xUs	0.15...0.3	0.15...0.3	0.4...0.6	0.4...0.6	0.15...0.3	0.15...0.3	0.15...0.3
Consumption								
Magnetic circuit closed	(W)	5.5	8	10	10	6.5	10.4	20
Magnetic circuit opened (W)		5.5	8	170	170	6.5	10.4	20
Opening and closing times								
Values between + 10 % U_s and - 20 % U_s								
Time on energisation (NO)	(ms)	35...65	35...70	60...80	60...80	26...55	30...65	64...133
Time on de-energisation (NO)	(ms)	6...15	40...65	40...50	40...50	6...15	5...10	20...23
Values at U_s								
Time on energisation (NO)	(ms)	35...45	40...55	50...60	50...60	35...45	40...55	75...95
Time on de-energisation (NO)	(ms)	7...12	30...65	55...60	55...60	7...12	6...8	20...22
Mechanical endurance								
No load	10 ⁶ ops.	15	15	12	12	15	15	12
Maximum rate								
No load	ops./h	3600	3600	2500	2500	3600	3600	3600
AC1 and AC3 at rated power	ops./h	1200	1200	1200	600	1200	1200	1200
AC4 at rated power	ops./h	360	360	200	200	360	360	200

