



EXPERION PKS
RELEASE 501

Control Firewall User's Guide

EPDOC-XX20-en-501B

April 2018

Disclaimer

This document contains Honeywell proprietary information. Information contained herein is to be used solely for the purpose submitted, and no part of this document or its contents shall be reproduced, published, or disclosed to a third party without the express permission of Honeywell International Sàrl.

While this information is presented in good faith and believed to be accurate, Honeywell disclaims the implied warranties of merchantability and fitness for a purpose and makes no express warranties except as may be stated in its written agreement with and for its customer.

In no event is Honeywell liable to anyone for any direct, special, or consequential damages. The information and specifications in this document are subject to change without notice.

Copyright 2018 - Honeywell International Sàrl

Contents	3
Chapter 1 - About this guide	4
1.1 Revision History	4
Chapter 2 - Introduction	5
2.1 About this guide	5
2.1.1 Revision History	5
Chapter 3 - Control Firewall Overview	6
3.1 About CF9	6
Chapter 4 - Control Firewall Planning and Design	7
4.1 General Planning References	7
4.2 Identifying Control Firewall Components	7
Chapter 5 - Control Firewall Installation and Upgrades	9
5.1 Installation Declarations	9
5.2 Installing CF9 Input/Output Termination Assembly CC-TCF901	10
5.2.1 Fiber media reference specifications	10
5.2.2 To mount CF9 IOTA	11
5.2.3 To wire CF9 IOTA	12
5.3 Installing Control Firewall CC- PCF901	15
5.3.1 To install CF9	15
5.4 Installing Optional Fiber Optic Module CC-FSMX01 or CC-FMMX01	16
5.4.1 To install optional fiber optic module	16
5.5 Upgrading Control Firewall Firmware	17
Chapter 6 - Control Firewall Configuration	19
6.1 Adding CF9 to network	19
Chapter 7 - Control Firewall Operation	20
7.1 Control Firewall Startup	20
7.2 CF9 LED Descriptions	20
Chapter 8 - Control Firewall Maintenance	22
8.1 Periodic Checks	22
8.2 Recommended Spare Parts	22
8.3 Replacing Failed Control Firewall	22

ABOUT THIS GUIDE

1.1 Revision History

Revision	Date	Description
A	November 2017	Initial release of the document.
B	April 2018	Added attention under the section Upgrading Control Firewall Firmware

Intended audience

Personnel who are responsible for integrating Series C form-factor components with the Experion system.

Prerequisite skills

- Basic mechanical skills.
- Familiar with using this Experion application
 - Configuration Studio

How to use this guide

This guide is primarily a hardware reference for installing the Control Firewall in a Series C cabinet and interpreting the light emitting diode (LED) indications.

Related Documents

For information about related functions and tasks, see:

- Configuration Studio Overview
- Fault Tolerant Ethernet Status Display User's Guide
- Control Hardware Planning Guide

- [About this guide](#)

2.1 About this guide

2.1.1 Revision History

Revision	Date	Description
A	November 2017	Initial release of the document.
B	April 2018	Added attention under the section Upgrading Control Firewall Firmware

Intended audience

Personnel who are responsible for integrating Series C form-factor components with the Experion system.

Prerequisite skills

- Basic mechanical skills.
- Familiar with using this Experion application
 - Configuration Studio

How to use this guide

This guide is primarily a hardware reference for installing the Control Firewall in a Series C cabinet and interpreting the light emitting diode (LED) indications.

Related Documents

For information about related functions and tasks, see:

- Configuration Studio Overview
- Fault Tolerant Ethernet Status Display User's Guide
- Control Hardware Planning Guide

CONTROL FIREWALL OVERVIEW

- [About CF9](#)

3.1 About CF9

The nine-port, Control Firewall (CF9) serves as the Fault Tolerant Ethernet (FTE) communications center for a given Series C control network. It consists of a Control Firewall module that plugs into its associated CF9 input/output termination assembly (IOTA) as shown in the following figure.

Figure 3.1 Control Firewall (CF9) and IOTA

Control Firewall (CF9) with Series C IOTA

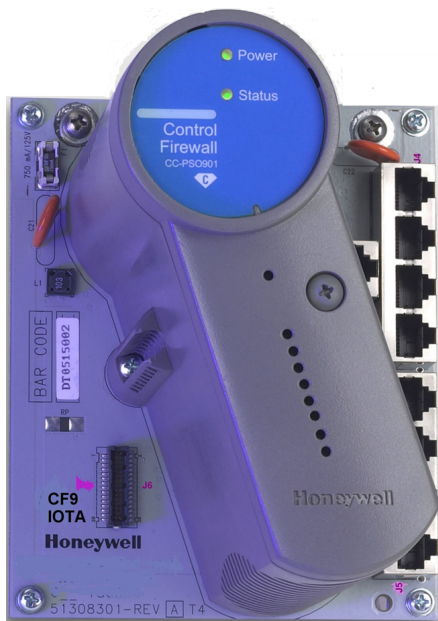

Control Firewall (CF9) with Series C Mark II IOTA



The CF9 provides eight ports for FTE connections to C300s and Series C FIMs within a Series C cabinet as well as FTE Bridge modules (FTEB) in a Series A Chassis I/O chassis. It has a ninth port for an uplink connection to the supervisory FTE network and level 2 control area. It provides network security by

- Rejecting all Ethernet messages not needed for control,
- Giving priority to traffic on downlink ports over ingress traffic on the uplink port, if the fabric becomes saturated, and
- Allowing only valid C300-compliant messages to pass on to the C300 domain.

CONTROL FIREWALL PLANNING AND DESIGN

This chapter contains the following topics.

- [General Planning References](#)
- [Identifying Control Firewall Components](#)

4.1 General Planning References

Please refer to the following documents for planning and design details for the Experion system in general and the Fault Tolerant Ethernet supervisory network. For the sake of brevity, this Guide does not repeat the applicable general guidelines, considerations, cautions, and so on that are covered in these other Guides.

- Control Hardware Planning Guide
- Server and Client Planning Guide
- Fault Tolerant Ethernet Overview and Implementation Guide

4.2 Identifying Control Firewall Components

The following table identifies the Control Firewall components that will be needed to provide a FTE interface with a Series C control system. The CC/DC prefix in a model number means the component's printed wiring boards are coated to provide additional protection from the environment and the CU prefix means the boards are uncoated.

Component	Description	Honeywell Model Number
Control Firewall Module (CF9)	Module mounts on CF9 Input/Output Termination Assembly (IOTA).	CC-PCF901
CF9 Input/Output Termination Assembly (IOTA)	Provides physical connection to Control Firewall module and FTE cables. Mounts on carrier in Series C cabinet.	CC-TCF901
CF9 Input/Output Termination Assembly (IOTA) for Series C Mark II	Provides physical connection to Control Firewall module and FTE cables. Mounts on backplane in Series C Mark II cabinet.	DC-TCF901
<i>Horizontal 9 Port FTE Control Firewall Input Output Termination Assembly (IOTA)</i>	Provides connection for eight FTE cables from in-cabinet controllers. The 9th port provides an uplink to the FTE supervisory network.	CC-HCN911
Ethernet Cables	Please see Planning Your Series C Control System In Control Hardware Planning Guide for information about Ethernet cables.	
Single Mode Fiber Module	FTE Single-Mode Fiber Module that plugs into one	CC-

Component	Description	Honeywell Model Number
(SMFIO)	port of IOTA.	FSMX01
Multi-Mode Fiber Module (MMFIO)	FTE Multi-Mode Fiber Module that plugs into one port of IOTA.	CC-FMMX01

ATTENTION

A combined IOTA is introduced for C300 and CF9 modules for use with the UHIO in TDC Basic cabinet migrations. For more information about the UHIO IOTA, see *Series C I/O User's Guide*.

CONTROL FIREWALL INSTALLATION AND UPGRADES

This chapter contains the following topics.

- [Installation Declarations](#)
- [Installing CF9 Input/Output Termination Assembly CC-TCF901](#)
- [Installing Control Firewall CC- PCF901](#)
- [Installing Optional Fiber Optic Module CC-FSMX01 or CC-FMMX01](#)
- [Upgrading Control Firewall Firmware](#)

5.1 Installation Declarations

ATTENTION

This equipment shall be installed in accordance with the requirements of the National Electrical Code (NEC), ANSI/NFPA 70, or the Canadian Electrical Code (CEC), C22.1. It is intended to be mounted within an enclosure or suitable environment acceptable to the local authority having jurisdiction, as defined in the NEC, or authorized person as defined in the CEC.

CAUTION

Electrostatic discharge can damage integrated circuits or semiconductors if you touch connector pins or tracks on a printed wiring board. Follow these guidelines when you handle any electronic component:

- Touch a grounded object to discharge static potential,
- Wear an approved wrist-strap grounding device,
- Do not touch the wire connector or connector pins,
- Do not touch circuit components inside a component,
- If available, use a static safe workstation,
- When not in use, keep the component in its static shield box or bag.

CAUTION

Unless the location is known to be non-hazardous, do not:

- connect or disconnect cables,
- install or remove fuses, terminal blocks, and so on, while the component is powered.

CAUTION

Do not connect Control Firewalls to interfaces configured for uplinks. Configure all Control Firewall interfaces for portfast before attaching the Control Firewall. Otherwise, interfaces connected to Control Firewalls will be blocked and cause loss of view upon recovery of a root switch in a network, which causes recalculation of the switch spanning tree topology. Control Firewalls do not use spanning tree.

5.2 Installing CF9 Input/Output Termination Assembly CC-TCF901

- [Fiber media reference specifications](#)
- [To mount CF9 IOTA](#)
- [To wire CF9 IOTA](#)

5.2.1 Fiber media reference specifications

Single-Mode Fiber Optic module CC-FSMX01

This module uses a dual-jacketed, dual-fiber cable (yellow) with an LC connector. Its applicable specifications are as follows.

Medium	Single-Mode Glass Fiber 9/125
Wavelength	1300 nm
Maximum Distance	15 km (9 miles)
Connector	LC
Voltage	3.3 V
Temperature	Industrial -40 C to +85 C (-40 F to +185 F)
Form Factor	SFP
Power	1 W Approximately

Multi-Mode Fiber Optic modules CC-FMMX01

This module uses a single-jacketed, dual-fiber cable (Orange) with an MT-RJ connector. Its applicable specifications are as follows.

Medium	Multimode Dielectric Fiber 62.5/125
Wavelength	1300 nm
Maximum Distance	2 km (1 mile)
Connector	MT-RJ
Voltage	3.3 V
Temperature	Industrial -40 C to +85 C (-40 F to +185 F)

Form Factor	SFF
Power	1 W Approximately

5.2.2 To mount CF9 IOTA

CAUTION

Be sure you do not fully tighten the IOTA mounting screws before installing and tightening the screws in the 24V + and COM terminals to keep these screws from binding during IOTA installation.

Series C IOTA size is 6 inches.

1. Select desired mounting location on carrier and align mounting holes in IOTA with screw hole locations on the carrier. See the following dimension drawing for details.
2.
 - Be sure component side of IOTA is facing up. Secure IOTA to carrier using screws, washers and spacers provided.
 - Insert spacers and washers between bottom of IOTA and top of carrier.
 - **Only tighten mounting screws half way.**

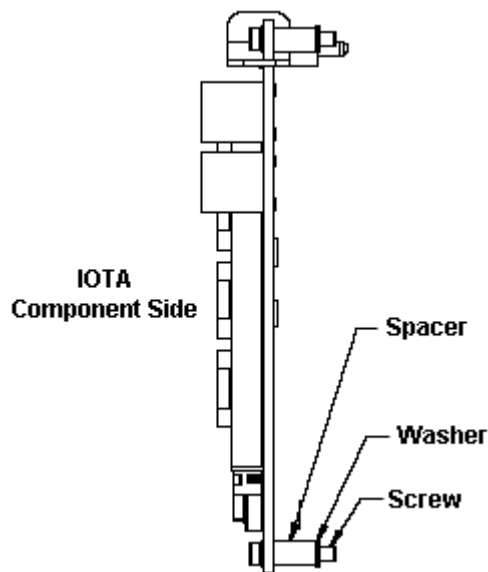

3. Tighten the screws in terminals **24 Vdc +** and **COM** (logic ground) to the vertical bus bar to connect the cabinet resident 24 Vdc power supply to the IOTA.
4. **Fully** tighten the mounting screws.
5. Repeat Steps 1 to 4 to mount the second CF9 IOTA immediately below the one that was just installed.
6. This completes the procedure. Go to Wiring IOTA for connection details.

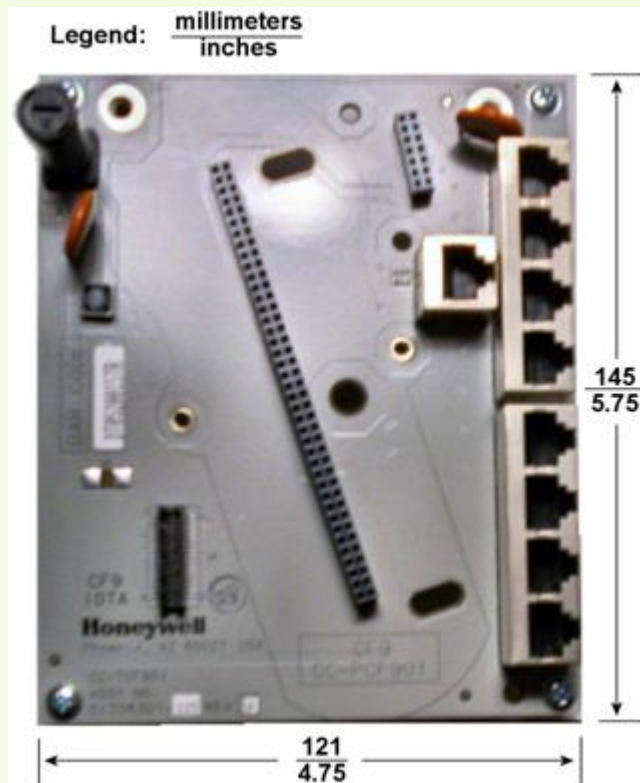

Figure 5.1 Mounting Dimensions for CF9 IOTA CC-TCF901

5.2.3 To wire CF9 IOTA

CF9 connection requirements

- You must always connect the Control Firewall uplink port to a Cisco switch.
 - You must not stack the Control Firewall.
 - You must connect the Control Firewall to an interface configured for portfast.
 - You must connect All Series C FIMs and C300s to a Control Firewall.
 - You must connect any FTE Bridge (FTEB) module communicating to a C300 to the same Control Firewall as the C300.
 - You may connect FTEB/C200 and FTEB/Series A FIM to level 1 configured switches according to the established best practices. For FTEB/Series A FIM, you also have an option to connect to a Control Firewall.
 - It is valid for an FTEB to be connected to a CF9, only when it is for a Series A FIM.
 - It is invalid for a CF9 to host a C200 through FTEB.
1.
 - Connect **yellow** FTE cable from **FTE A** link, L1/L2 Ethernet switch to the **J3** connector on the Control Firewall (CF9) to be used as the **FTE A** link (yellow cable)
 - Connect **green** FTE cable from **FTE B** link, L1/L2 Ethernet switch to the **J3** connector on another Control Firewall (CF9) to be used as the **FTE B** link (green cable) redundant IOTA.

2. Route **yellow** cables from four **J4** and four **J5** connectors on the CF9 for **FTE A** links to corresponding **FTE A** ports on C300s, Series C FIMs, and FTE Bridge modules, as required.
3. Route **green** cables from four **J4** and four **J5** connectors on the other redundant CF9 IOTA for **FTE B** links to corresponding **FTE B** ports on C300s, Series C FIMs, and FTE Bridge modules, as required.
4. This completes the procedure. Go to the next section.

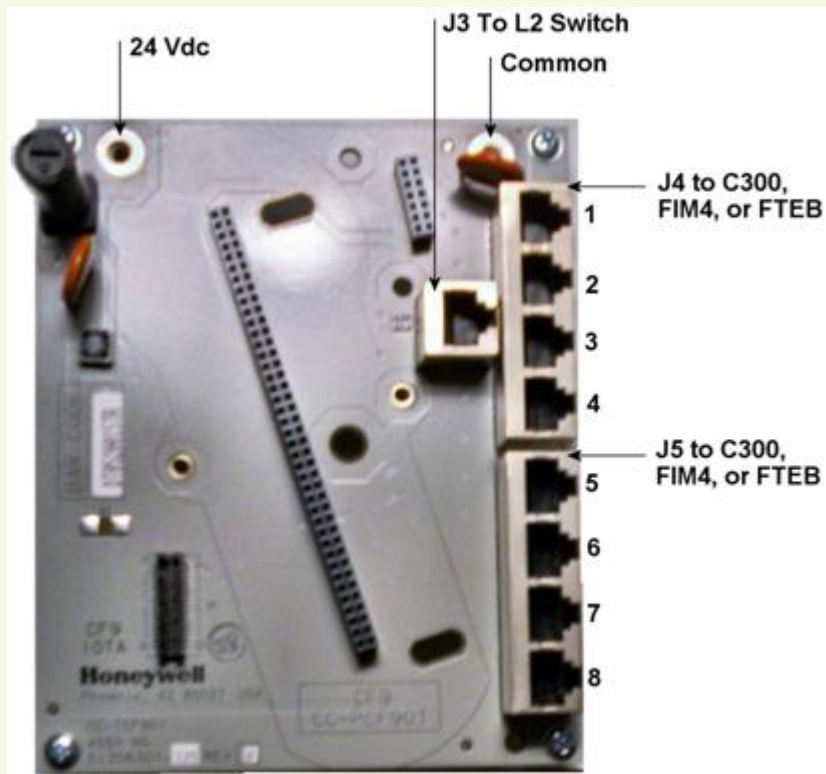
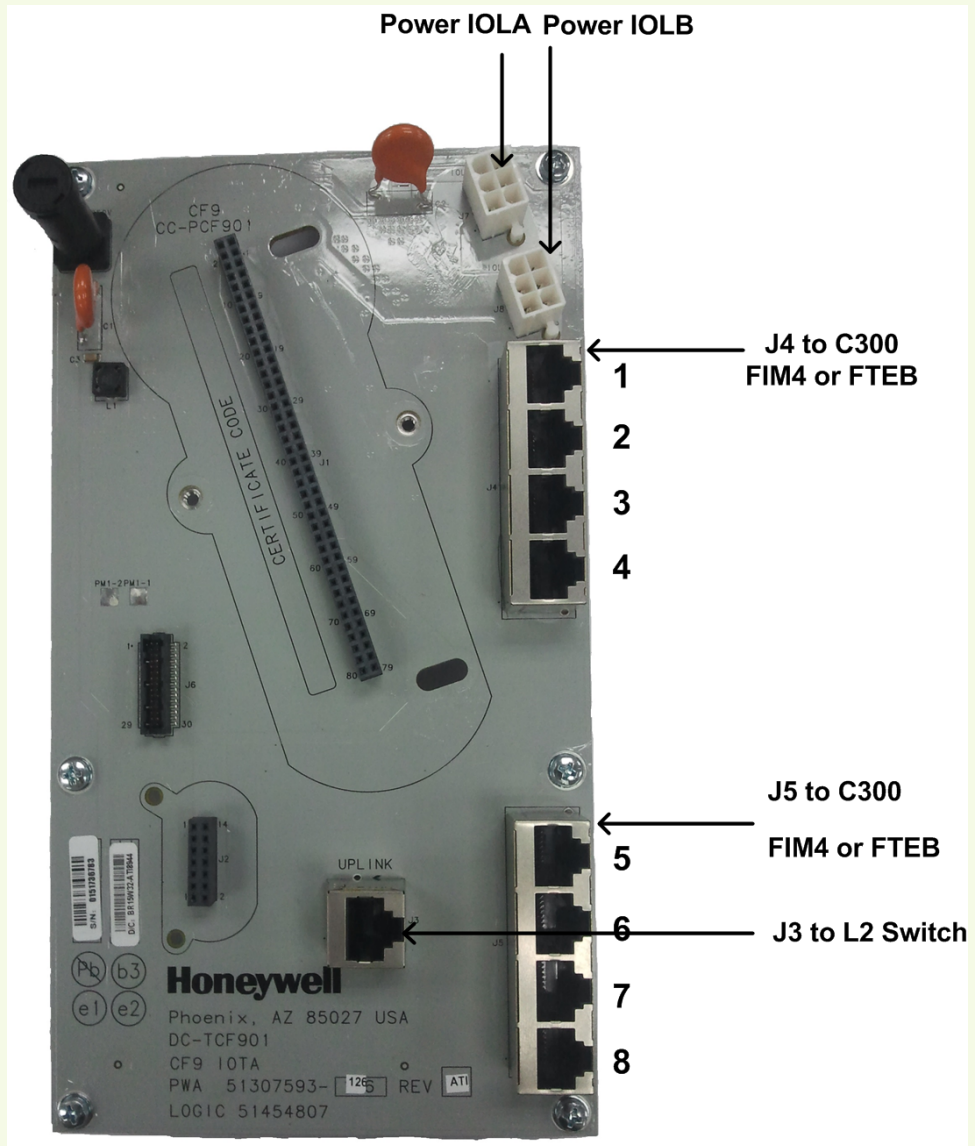

Figure 5.2 Typical Connector Locations on CF9 IOTA for Series C

Figure 5.3 Typical Connector Locations on CF9 IOTA for Series C Mark II



5.3 Installing Control Firewall CC- PCF901

- [To install CF9](#)

5.3.1 To install CF9

The following caution is not applicable for Series C Mark II.

CAUTION

Use only a #2 Phillips screw driver to carefully tighten the long gray plastic screw on the Module's face. **Do not use** either a #1 Phillips screw driver or a battery powered screw driver to remove or install the plastic screw as this can damage the screw head.

1. Align CF9 connector pins over the connector/slot on the IOTA labeled as Control Firewall 9 Module.
2. Carefully press down on the CF9 module until it is fully seated in the connector.
3. Use the screws provided to secure the CF9 module to the IOTA. The screws must be tightened to 1.3 Newton-meters.
4. Repeat Steps 1 to 3 to install other CF9s on their IOTAs, as required.
5. This completes the procedure. Go to the next Section.

5.4 Installing Optional Fiber Optic Module CC-FSMX01 or CC-FMMX01

- [To install optional fiber optic module](#)

5.4.1 To install optional fiber optic module

Use the following procedure to install an optional fiber optic module on a CF9 IOTA. This procedure assumes that this is an initial installation for the CF9 IOTA and no prior uplink RJ-45 plug connection has been made.

CAUTION

This caution is not applicable for Series C Mark II.

Only use a #2 Phillips screw driver to carefully loosen or tighten the long gray plastic screw on the CF9 Module's face. Do not use either a #1 Phillips screw driver or a battery powered screw driver to remove or install the plastic screw as this can damage the screw head.

ATTENTION

For Series C Mark II CF9, do not connect FTE switch with fiber cable and RJ-45 cable at the same time.

1. If the CF9 IOTA is installed on a carrier in a cabinet, loosen the screws holding the Control Firewall module to the IOTA and remove the module from the IOTA so power is removed from the J2 connector on the IOTA. (It is not necessary to completely remove the long gray plastic screw located on the module's face.)
2. Carefully align the pins in the bottom of the fiber optic module with the sockets in the J2 connector on the IOTA and gently push down on the module until it is fully seated.

3. Tighten the two screws in the base of the module to secure it to the IOTA as shown in the following example illustration.

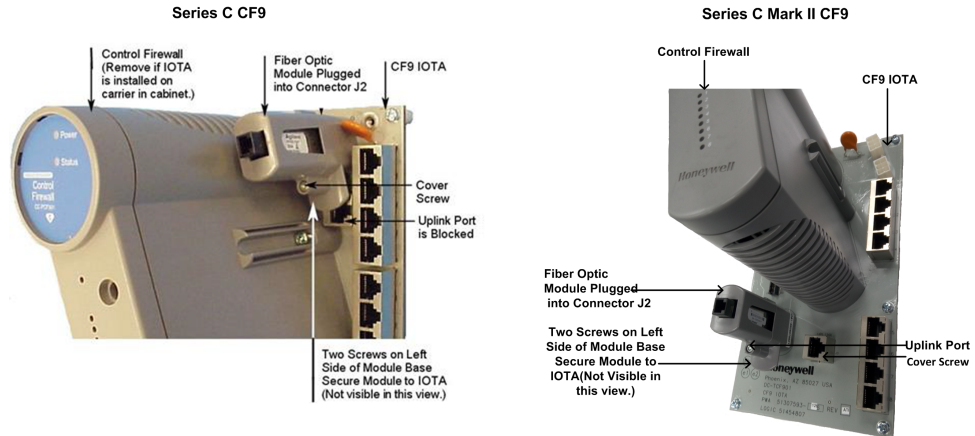

4. Connect appropriate fiber optic cable to the LC or MTRJ plug provided with the fiber optic module.
5. Plug the cable plug into the fiber optic module port as shown in the example illustration below.

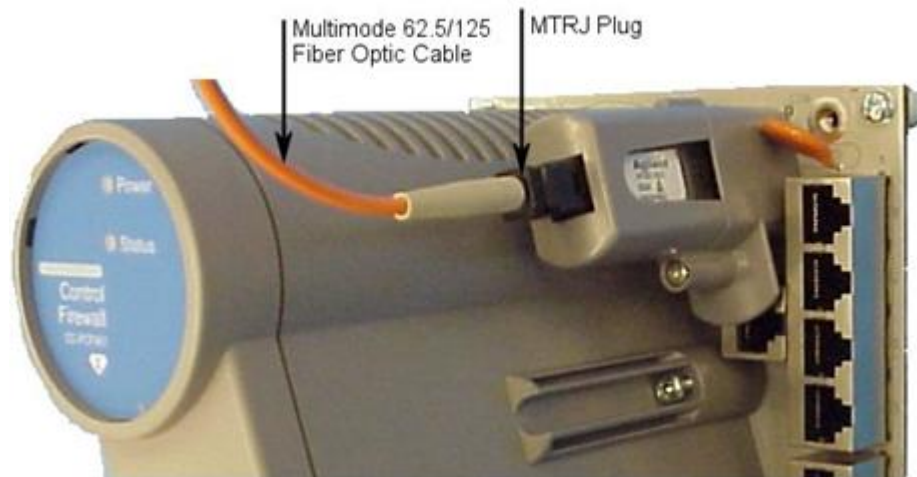

6. If applicable, install the Control Firewall module on the IOTA.
7. This completes the procedure.

5.5 Upgrading Control Firewall Firmware

You can update the Control Firewall firmware using the Control Firewall Update tool. You can launch the tool from the Configuration Studio or as a standalone tool. Refer to the About the Control Firewall Update tool topic in the System Definition and Configuration online help for information on launching the tool. Refer to the Software Change Notice (SCN) supplied with your Experion system for the latest firmware version and file location details.

ATTENTION

Don't upgrade a CF9 pair together, since it may cause a LOV situation, make sure that you have identify each pair., During the time of upgrade, if it is possible use only, one instance of the tool at a time.

CONTROL FIREWALL CONFIGURATION

This chapter contains the following topic.

- [Adding CF9 to network](#)

6.1 Adding CF9 to network

You can add a Control Firewall (CF9) to be visible on the Network Tree in Configuration Studio. Please refer to the Adding and Configuring Switches and Control Firewall topic in the System Definition and Configuration help in Configuration Studio for details.

CONTROL FIREWALL OPERATION

- [Control Firewall Startup](#)
- [CF9 LED Descriptions](#)

7.1 Control Firewall Startup

The following table summarizes the stages the CF9 goes through after power is applied to its IOTA during startup. The CF9 repeats these stages every time power is cycled Off/On or the pins on its reset pad are shorted.

1. Power Light Emitting Diode (LED) lights (green).
2. Status LED is red while the CF9 runs its power-on self test (POST).
3. When the CF9 POST completes, the Status LED turns green and the FTE port LEDs blink green and off for all connected ports when there is traffic, and remain steady green for connected ports when there is no traffic. The LEDs for unconnected FTE ports are off.

7.2 CF9 LED Descriptions

The following illustration and table identify and describe the indications associated with the LEDs on the CF9.

Figure 7.1 LEDs on CF9

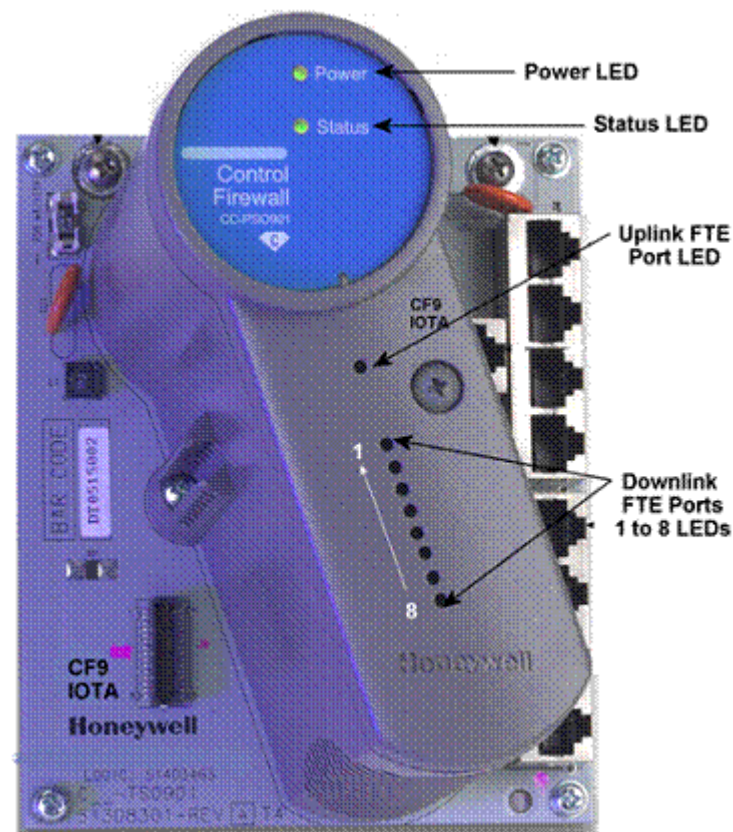

LED	State				
	Off	Green	Red	Blinking Green	Green with Brief Flicker
Power	No Power	Power On	See Note 1	-	-
Status	No Power or Fault	Normal Operation	Running POST	See Note 2	-
Downlink Ports 1 to 8	No Power or No Cable Connected	Link Present, No Traffic	-	Link Present, Traffic	Too Many Attached Devices
Uplink Port	No Power or No Cable Connected	Link Present, No Traffic	-	Link Present, Traffic	-
Notes					
1. The - indicates the LED is never in this state.					
2. The CF9 has detected a soft failure and is working in a diminished state. Typical causes are a disconnected uplink port cable or a downlink port with too many attached devices. (Only one device can be attached to a CF9 downlink port.)					

CONTROL FIREWALL MAINTENANCE

This topic includes the following topics.

- [Periodic Checks](#)
- [Recommended Spare Parts](#)
- [Replacing Failed Control Firewall](#)

8.1 Periodic Checks

The following table identifies checks that you should make periodically (every 3 to 6 months) to keep the CF9 in good working condition.

Check . . .	Possible Corrective Action . . .
That all light emitting diodes (LED) are working.	If LED is not lit or has dimmed, you must replace the CF9 module, since LEDs are not field replaceable.
That all connections are secure.	Secure connections, as needed.
That cable insulation is not worn or cracked.	Replace cables, as required.
That IOTA is secure.	Tighten mounting screws.

8.2 Recommended Spare Parts

The following table provides a list of parts that you may want to keep on hand for backup

Part Name	Part Number	Description	Quantity per 10/100
Control Firewall	CC- or CU-PFB401	Series C Control Firewall Module	1/5
CF9 IOTA	CC- or CU-TFB401	Nine-Port Ethernet Input/Output Terminal Assembly	1/2
Fuse	51506438-341	800 mA, 250V quick-acting fuse on Input Output Terminal Assembly	4/25
SMFIO	CC-FSMX01	Single-Mode Fiber Optic Module	Optional
MMFIO	CC-FMMX01	Multi-Mode Fiber Optic Module	Optional

8.3 Replacing Failed Control Firewall

Just reverse the steps in the previous installation procedures for mounting and wiring the CF9

and its associated IOTA, as required. You can replace the CF9 module without removing the IOTA. Please observe the following cautions and warnings.

CAUTION

We recommend that you proceed with **extreme caution** whenever replacing any component in a control system. Be sure the system is offline or in a safe operating mode. Component replacements may also require corresponding changes in the control strategy configuration through Control Builder, as well as downloading appropriate data to the replaced component.

CAUTION

Unless the location is known to be non-hazardous, **do not** :

- connect or disconnect cables,
- install or remove fuses, terminal blocks, and so on,

while the component is powered.

CAUTION

This caution is not applicable for Series C Mark II.

Only use a #2 Phillips screw driver to carefully loosen or tighten the long gray plastic screw on the CF9 Module's face. **Do not** use either a #1 Phillips screw driver or a battery powered screw driver to remove or install the plastic screw as this can damage the screw head.

CAUTION

Be sure you use the following sequence when removing an IOTA.

- Only loosen the IOTA mounting screws **half way**.
- **Remove** the screws in the **24V +** and **COM** terminals.
For Series C Mark II, remove the **combo cable**.
- **Remove** the mounting screws and the IOTA.

Notices

Trademarks

Experion®, PlantScape®, SafeBrowse®, TotalPlant®, ControlEdge™, and TDC 3000® are registered trademarks of Honeywell International, Inc.

OneWireless™ is a trademark of Honeywell International Sàrl

Other trademarks

Microsoft and SQL Server are either registered trademarks or trademarks of Microsoft Corporation in the United States and/or other countries.

Trademarks that appear in this document are used only to the benefit of the trademark owner, with no intention of trademark infringement.

Third-party licenses

This product may contain or be derived from materials, including software, of third parties. The third party materials may be subject to licenses, notices, restrictions and obligations imposed by the licensor. The licenses, notices, restrictions and obligations, if any, may be found in the materials accompanying the product, in the documents or files accompanying such third party materials, in a file named third_party_licenses on the media containing the product, or at <http://www.honeywell.com/ps/thirdpartylicenses>.

Documentation feedback

You can find the most up-to-date documents on the Honeywell Process Solutions support website at:

- <http://www.honeywellprocess.com/support>

If you have comments about Honeywell Process Solutions documentation, send your feedback to:

- hpsdocs@honeywell.com

Use this email address to provide feedback, or to report errors and omissions in the documentation. For immediate help with a technical problem, contact your local Honeywell Process Solutions Customer Contact Center (CCC) or Honeywell Technical Assistance Center (TAC).

How to report a security vulnerability

For the purpose of submission, a security vulnerability is defined as a software defect or weakness that can be exploited to reduce the operational or security capabilities of the software.

Honeywell investigates all reports of security vulnerabilities affecting Honeywell products and services.

To report a potential security vulnerability against any Honeywell product, please follow the instructions at:

<https://honeywell.com/pages/vulnerabilityreporting.aspx>

Submit the requested information to Honeywell using one of the following methods:

- Send an email to security@honeywell.com.
- or
- Contact your local Honeywell Process Solutions Customer Contact Center (CCC) or Honeywell Technical Assistance Center (TAC) listed in the “Support” section of this document.

Support

For support, contact your local Honeywell Process Solutions Customer Contact Center (CCC). To find your local CCC visit the website, <https://www.honeywellprocess.com/en-US/contact-us/customer-support-contacts/Pages/default.aspx>.

Training classes

Honeywell holds technical training classes about Experion PKS. These classes are taught by experts in the field of process control systems. For more information about these classes, contact your Honeywell representative, or see <http://www.automationcollege.com>.